

Cabinet Refrigerators/ Freezers

Instruction manual



(NL) Koelkasten/ vriestkasten	9	(IT) Armadi frigoriferi/ congelatori	30
Handleiding		Manuale di istruzioni	
(FR) Armoires réfrigérantes/ congélateurs	16	(ES) Frigoríficos / Congeladores de cabina	37
Mode d'emploi		Manual de instrucciones	
(DE) Koelkast/Vriezer	23	(PT) Frigoríficos/congeladores	44
Bedienungsanleitung		Manual de instruções	

**PLEASE READ THE OPERATION MANUAL BEFORE USING.
SAVE THIS MANUAL FOR LATER USE.**

Safety Tips

- Position on a flat, stable surface.
- A service agent/qualified technician should carry out installation and any repairs if required. Do not remove any components or service panels on this product.
- Consult Local and National Standards to comply with the following:
 - Health and Safety at Work Legislation
 - EN Codes of Practice
 - Fire Precautions
 - IEE Wiring Regulations
 - Building Regulations
- DO NOT use jet/pressure washers to clean the appliance.
- DO NOT use the appliance outside.
- DO NOT use this appliance to store medical supplies.
- DO NOT use electrical appliances inside the appliance (e.g. heaters, ice cream makers etc.)
- DO NOT stand or support yourself on the base, drawers or doors.
- DO NOT allow oil or fat to come into contact with the plastic components or door seal. Clean immediately if contact occurs.
- Bottles that contain a high percentage of alcohol must be sealed and placed vertically in the refrigerator.
- Always carry, store and handle the appliance in a vertical position and move by holding the base of the appliance.
- Always switch off and disconnect the power supply to the unit before cleaning.
- Keep all packaging away from children. Dispose of the packaging in accordance with the regulations of local authorities.

- If the power cord is damaged, it must be replaced by a agent or a recommended qualified technician in order to avoid a hazard.



Caution Risk of Fire

- Do not store explosive substances such as aerosol cans with a flammable propellant in this appliance.
- **Warning:** Keep clear of obstruction all ventilation openings in the appliance enclosure or in the structure for building-in.
- **Warning:** Do not use mechanical devices or other means to accelerate the defrosting process, other than those recommended by the manufacturer.
- **Warning:** Do not damage the refrigerant circuit.
- **Warning:** Do not use electrical appliances inside the food storage compartments of the appliance, unless they are the type recommended by the manufacturer.

Introduction

Please take a few moments to carefully read through this manual. Correct maintenance and operation of this machine will provide the best possible performance from your product.

Pack Contents

The following is included:

- Refrigerator or Freezer
- Keys x 2
- Shelf guides x 6 (Single) / x 12 (Double)
- Shelves x 3 (Single) / x 6 (Double)
- Waste water tray
- Instruction manual

Prides itself on quality and service, ensuring that at the time of packaging the contents are supplied fully functional and free of damage.

Should you find any damage as a result of transit, please contact your dealer immediately.

Installation



Note: If the unit has not been stored or moved in an upright position, let it stand upright for approximately 12 hours before operation. If in doubt allow to stand.

1. Remove the appliance from the packaging. Make sure that all protective plastic film and coatings are thoroughly removed from all surfaces.
2. Maintain a distance of 20cm (7 inches) between the unit and walls or other objects for ventilation. Increase this distance if the obstacle is a heat source.



Note: Before using the appliance for the first time, clean the shelves and interior with soapy water.

3. Set the brakes on the castors to keep the appliance in position
OR
Level the appliance by adjusting the screw feet.

Removing the Compressor Safety Band

- The compressor is located on the top of the appliance, and sits on rubber washers. Under normal operating conditions the compressor is allowed to vibrate.
- To avoid damage through excessive motion during transit, a stainless steel safety band is placed over the compressor and screwed into the top of the appliance.
- This safety band and the two screws fixing it to the appliance must be removed before the appliance is turned on.

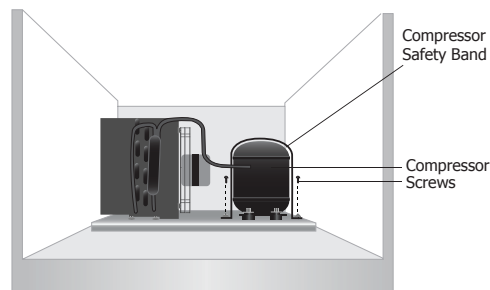

Lock/Unlock the Doors

A lock is fitted to the doors to ensure foodstuffs are kept secure within your appliance.

Use the keys provided to lock/unlock the doors.

Fitting the Waste Water Tray

The waste water tray comes ready to fit to the underside of the appliance.

Slide the tray into the runners situated under the appliance.

Fitting the Shelves & Floor Guards

1. Place one set of shelf guides on either side of the cabinet at the desired height.
2. Slide the shelf into place.
3. Repeat for the remaining shelves.
4. Place the floor guards on the floor of the cabinet, ensuring the flat side is clear of the floor.



Note: This is vital for ensuring correct drainage of condensation.

Operation

Storing Food

To get the best results from your appliance, follow these instructions:

- Only store foodstuffs in the appliance when it has reached the correct operating temperature.
- Do not place uncovered hot food or liquid inside the appliance.
- Wrap or cover food where possible.
- Do not obstruct the fans inside the appliance.
- Avoid opening the doors for prolonged periods of time.

Turn On

1. Ensure the power switch is set to [O] and turn on at the socket.
2. Switch on the Power [I]. The current temperature within the appliance is displayed.

Control Panel

To unlock / Lock the keyboard press ▲ and ▼ together for 3 seconds. Display will flash PON (unlocked) / POF (locked).

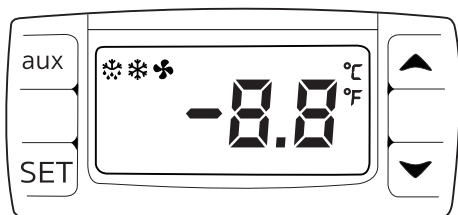

Set the Operating Temperature

1. Press the **SET** button. The display will flash.
2. Press the ▲ or ▼ buttons to display the required temperature.
3. Press the **SET** button to store the temperature.

Manual Defrost

Press and hold the defrost button "aux" for 2 seconds to begin a manual defrost. The defrost light illuminates.

Cleaning, Care & Maintenance



Defrost appliance at least every 3 months, more often if required.

Switch off and disconnect from the power supply before cleaning.

- Clean the interior of the appliance as often as possible.
- Do not use abrasive cleaning agents. These can leave harmful residues.
- Clean the door seal with water only.
- Always wipe dry after cleaning.
- Do not allow water used in cleaning to run through the drain hole into the evaporation pan.
- Take care when cleaning the rear of the appliance. Sharp edges can cut.
- A agent or qualified technician must carry out repairs if required.

Stainless Steel Care

To maintain the stainless steel exterior of your item, please consider the following information:

Never:

- Use abrasive Scourers or scrubbing pads etc
- Use Chlorinated or acidic detergents
- Allow anything e.g. food, dirt, cleaning chemicals to remain on the surface for longer than necessary, clean them off right away.
- Allow the surface to remain wet.

Do:

- Clean often.
- Use soft Cloths or plastic Scourers.
- Rub with the grain of the metal, rather than across it.
- Use detergents and polish designed for cleaning Stainless Steel.
- Ensure that the cleaning products are washed off fully and that the steel is left dry.

Routine Maintenance

Cleaning the Condenser

- The condenser is part of the refrigeration system. The condenser requires monthly cleaning.
- Always disconnect power supply before carrying out Routine Maintenance.
- Failure to clean the condenser will reduce the performance and life of your unit and may invalidate your warranty.

Upright Cabinets

The condenser is located below the refrigeration cabinet. These models have a removable filter which can be cleaned with a vacuum cleaner.

Upright Cabinets

The condenser is located above the refrigeration cabinet. These models have a removable filter which can be cleaned with a vacuum cleaner.

Troubleshooting

If your appliance develops a fault, please check the following table before making a call to the Helpline or your dealer.

Fault	Probable Cause	Solution
The appliance is not working	The unit is not switched on	Check the unit is plugged in correctly and switched on
	Plug and lead are damaged	Call agent or qualified Technician
	Fuse in the plug has blown	Replace the fuse
	Power supply	Check power supply
	Internal wiring fault	Call agent or qualified Technician
The appliance turns on, but the temperature is too high/low	Too much ice on the evaporator	Defrost the appliance
	Condenser blocked with dust	Clean the Condenser
	Doors are not shut properly	Check doors are shut and seals are not damaged
	Appliance is located near a heat source or air flow to the condenser is being interrupted	Move the refrigerator to a more suitable location
	Ambient temperature is too high	Increase ventilation or move appliance to a cooler position
	Unsuitable foodstuffs are being stored in the appliance	Remove any excessive hot foodstuffs or blockages to the fan
The appliance is leaking water	Appliance is overloaded	Reduce the amount of food stored in the appliance
	The appliance is not properly levelled	Adjust the screw feet to level the appliance (if applicable)
	The discharge outlet is blocked	Clear the discharge outlet
	Movement of water to the drain is obstructed	Clear the floor of the appliance (if applicable)
	The water container is damaged	Call agent or qualified Technician
The appliance is unusually loud	The drip tray is overflowing	Empty the drip tray (if applicable)
	The safety band has not been removed	Remove the safety band
	Loose nut/screw	Check and tighten all nuts and screws
	The appliance has not been installed in a level or stable position	Check installation position and change if necessary

Electrical Wiring

The plug is to be connected to a suitable mains socket.

Appliances are wired as follows:

- Live wire (coloured brown) to terminal marked L
- Neutral wire (coloured blue) to terminal marked N
- Earth wire (coloured green/yellow) to terminal marked E

All appliances must be earthed, using a dedicated earthing circuit.



If in doubt consult a qualified electrician.

Electrical isolation points must be kept clear of any obstructions. In the event of any emergency disconnection being required they must be readily accessible.

Disposal

EU regulations require refrigeration product to be disposed of by specialist companies who remove or recycle all gasses, metal and plastic components.

Consult your local waste collection authority regarding disposal of your appliance. Local authorities are not obliged to dispose of commercial refrigeration equipment but may be able to offer advice on how to dispose of the equipment locally.

Alternatively call the helpline for details of national disposal companies within the EU.

Compliance

The WEEE logo on this product or its documentation indicates that the product must not be disposed of as household waste. To help prevent possible harm to human health and/or the environment, the product must be disposed of in an approved and environmentally safe recycling process. For further information on how to dispose of this product correctly, contact the product supplier, or the local authority responsible for waste disposal in your area.



Parts have undergone strict product testing in order to comply with regulatory standards and specifications set by international, independent, and federal authorities.

Products have been approved to carry the following symbol:

Veiligheidstips

- Plaatsen op een vlakke en stabiele ondergrond.
- De installatie en eventuele reparaties zijn door een servicetechnicus/vaktechnicus uit te voeren. Verwijder geen componenten of servicepanelen van dit product.
- Raadpleeg en volg de plaatselijke en nationale regelgeving op m.b.t. tot het volgende:
 - Wetgeving van gezondheid en veiligheid op de werkplaats
 - Werkregels
 - Brandpreventie
 - IEE bekabelingsnormen
 - Bouwverordeningen
- Dit product NIET reinigen met spuit-/drukreinigers.
- Dit product NIET gebruiken voor de berging van medische producten.
- In dit product GEEN elektrische apparaten gebruiken (zoals bijv. verwarmers, ijsmakers, etc.)
- NIET op de kastbasis, lades en deuren staan of als ondersteuning gebruiken.
- Laat NIET toe dat olie of vet in contact komt met plastic componenten of deurafdichtingen. Onmiddellijk reinigen indien dit wel gebeurt.
- Uitsluitend geschikt voor gebruik binnenshuis.
- Flessen met een hoog alcoholpercentage moet goed worden gesloten en verticaal in de koelkast worden bewaard.
- Dit product altijd in een verticale positie vervoeren, opbergen en gebruiken. Het product aan de kastbasis vervoeren.
- Alvorens dit product te reinigen dient men altijd de stroomvoorziening uit te schakelen.
- Laat verpakkingsmateriaal niet binnen handbereik van kinderen. Verpakkingsmateriaal in overeenstemming met de regelgeving van de plaatselijke overheden als afval laten verwerken.

- Indien de stroomkabel beschadigd raakt, dient men deze door een technicus of een aanbevolen vaktechnicus te laten vervangen om gevaarlijke situaties te verhinderen.



Voorzichtig Risico van Fire

- Heeft explosieve stoffen zoals spuitbussen niet slaan met een brandbaar drijfgas in dit apparaat.
- **Waarschuwing:** Houd vrij van obstakels alle ventilatieopeningen in het apparaat behuizing of in de structuur voor de bouw-in.
- **Waarschuwing:** mechanische apparaten of andere middelen niet gebruiken om het ontdooien te versnellen, met uitzondering van de fabrikant aanbevolen die door.
- **Waarschuwing:** het koelcircuit niet beschadigen.
- **Waarschuwing:** Gebruik geen elektrische apparaten binnen het voedsel opbergvakken van het apparaat, tenzij ze het type aanbevolen door de fabrikant.

Inleiding

Neem de tijd en lees deze handleiding aandachtig door. Een correct gebruik en onderhoud van deze machine waarborgt de beste prestatie van uw product.

Verpakkingsinhoud

De verpakking bevat het volgende:

- Koelkast of Vrieskast
- Sleutels x 2
- Ladegeleiders x 6 (enkele) / x 12 (dubbele)
- Vloerplint (1 per deur)
- Lades x 3 (enkele)/ x 6 (dubbele)
- Afvoerwaterbak
- Handleiding

Is trots op de haar productkwaliteit en dienstverlening en controleer de inhoud van de verpakkingen, tijdens de verpakkingsfase, op functionaliteit en schade.

Mocht u product door transport zijn beschadigd, neem dan onmiddellijk contact op met uw dealer.



Opmerking: indien het apparaat niet in een rechtopstaande positie is opgeslagen of vervoerd, dient men het product 12 uur vóór gebruik in de rechtopstaande positie te plaatsen. Bij twijfel dient men het product in een rechtopstaande positie te plaatsen.

1. Haal het product uit de verpakking. Zorg ervoor dat u de beschermingsfolie en -lagen van alle oppervlakken heeft verwijderd.
2. Voor een adequate ventilatie dient men een afstand van 20cm aan te houden tussen dit product of muren en andere objecten. Vergroot deze afstand indien het object een warmtebron is.



Opmerking: Voor het eerste gebruik van dit product dient u de lades en de binnenzijde met zeepwater te reinigen.

3. Zet de remmen van de wieltjes om het product op zij plaats vast te zetten OF nivelleer het product door de verstelbare poten aan te passen.

Veiligheidsband van de compressor verwijderen

- De compressor bevindt zich in het bovendee van het product en steunt op rubberen onderlegplaatjes. Onder normale werkomstandigheden is het trillen van de compressor normaal.
- Om beschadiging tijdens teveel bewegingen tijdens transport te voorkomen, is er een veiligheidsband om de compressor geplaatst en vastgeschroefd in het bovendee van het product.
- Men dient de veiligheidsband en de bijbehorende twee bevestigingsschroeven te verwijderen alvorens het product aan te zetten.

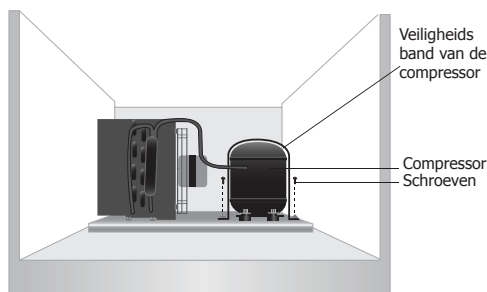

Vergrendelen/ontgrendelen van deuren

De deuren zijn voorzien van een slot om de levensmiddelen veilig te bewaren in uw product. Gebruikt de meegeleverde sleutels om de deuren te vergrendelen/ontgrendelen.

Het plaatsen van de afvoerwaterlade

De afvoerwaterlade is klaar voor plaatsing in het onderdeel van het product.

Schuif de lade op de geleiders aan de onderzijde van het product.

Het plaatsen van de lades & vloerplinten

1. Plaats één set van de ladegeleiders aan beide zijden van de kast en op de gewenste hoogte.
2. Schuif de lade op zij plaats.
3. Herhaal deze handeling voor de overige lades.
4. Plaats de vloerplinten aan de onderkant van de kast en zorg dat het vlakke deel niet in contact is met de vloer.



Opmerking: dit is uiterst belangrijk zodat een correcte afvoer van condenswater wordt gewaarborgd.

Bediening

Opslag van levensmiddelen



Volg de volgende aanwijzingen voor de beste resultaten met uw product:

- Bewaar uitsluitend levensmiddelen in het product wanneer het product de juiste gebruikstemperatuur heeft bereikt.
- Plaats geen open warme levensmiddelen of vloeistof in het product.
- Voedsel bedekken en inwickelen wanneer mogelijk.
- Niet de interne ventilatoren in het product blokkeren.
- Laat de deuren niet al te lang openstaan.

Inschakelen

1. Controleer of stroomschakelaar in de positie [O] staat en de steker in het stopcontact zit.
2. Zet de Power (Stroom) [I] aan. De actuele interne temperatuur van het product wordt weergegeven.

Bedieningspaneel

Te ontgrendelen / vergrendelen van het toetsenbord drukt  en  samen gedurende 3 seconden. Knippert PON (Unlocked) / POF (gesloten).

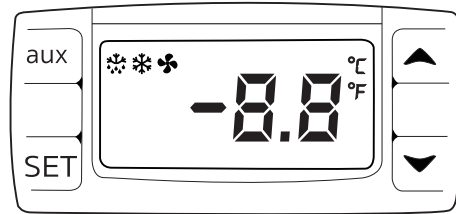

Werktemperatuur instellen

1. Druk op de **SET** knop. Het display knippert.
2. Druk op de  of  knoppen om de vereiste temperatuur weer te geven.
3. Druk op de **SET** knop om de temperatuurwaarde op te slaan.

Handmatig ontdooien

De knop "aux" indrukken en gedurende 2 seconden ingedrukt houden om ontdooiing te starten. Het ontdooiingslampje gaat aan.

Reiniging, zorg & onderhoud



Ontdooien apparaten ten minste om de 3 maanden, vaker indien nodig.

Alvorens het apparaat te reinigen dient men de stroomvoorziening uit te schakelen.

- Reinig zo vaak mogelijk de binnenkant van het product.
- Gebruik géén schurende reinigingsmiddelen. Dergelijke middelen kunnen schadelijke resten achterlaten.
- Reinig de deurafdichting uitsluitend met water.
- Na reiniging altijd droogmaken.
- Het voor reiniging gebruikte water mag niet door het afvoergat naar de verdampingspan stromen.
- Ga voorzichtig te werk bij het reinigen van de achterzijde van het product. Scherpe randen kunnen snijwonden veroorzaken.
- Eventuele reparaties moeten door een technicus of een vaktechnicus worden uitgevoerd.

Verzorging van roestvrij staal

De volgende informatie betreft het onderhoud van de roestvrijstalen buitenkant van het product.

Nooit:

- schurende blokjes of sponsjes etc. gebruiken;
- reinigingsmiddelen met chloor of zuur gebruiken;
- toelaten dat voedsel, vuil, chemische reinigingsmiddelen enz. langer dan nodig op het oppervlak achterblijven - verwijder ze onmiddellijk;
- toelaten dat het oppervlak nat blijft.

Wel:

- vaak schoonmaken;
- zachte doeken en plastic sponsjes gebruiken;
- met de draad van het metaal mee wrijven, in plaats van tegen de draad in;
- reinigings- en poetsmiddelen gebruiken die speciaal voor roestvrij staal zijn bedoeld;
- ervoor zorgen dat de reinigingsproducten volledig worden afgespoeld en dat het staal droog achter blijft.

Routine-onderhoud

Reiniging van condensor

- De condensor maakt deel uit van het koelsysteem. De condensor moet maandelijks worden schoongemaakt.
- Haal altijd eerst de stekker uit het stopcontact voordat routine-onderhoud wordt uitgevoerd.
- Als de condensor niet wordt schoongemaakt, heeft dit een nadelige invloed op de prestaties en het leven van de machine en kan de garantie ongeldig worden.

Rechtopstaande kasten

De condensor zit onder de koelkast. Deze modellen hebben een uitneembaar filter dat met een stofzuiger kan worden schoongemaakt.

Rechtopstaande kasten

De condensor zit boven de koelkast. Deze modellen hebben een uitneembaar filter dat met een

stofzuiger kan worden schoongemaakt.

Oplossen van problemen

Indien er een storing van uw product optreedt, dient u de onderstaande tabel te raadplegen alvorens contact op te nemen met uw dealer of de Hulplijn te bellen.

Probleem	Mogelijke oorzaak	Handeling
Het apparaat werkt niet	Het apparaat staat uit	Controleer of de stroomkabel van het apparaat is aangesloten en of het apparaat is ingeschakeld
	Steker en kabel zijn beschadigd	Laat een technicus of een vaktechnicus komen
	De zekering in de steker is gesprongen	Vervang de zekering in de steker
	Stroomvoorziening	Controleer de stroomvoorziening
	Storing interne bedrading	Laat een technicus of een vaktechnicus komen
Het product staat aan maar de temperatuur is te hoog/laag	Teveel ijs in de verdamper	Ontdooi het product
	Condensor wordt geblokkeerd door stof	Reinig de condensor
	Deuren niet goed gesloten	Controleren of de deuren goed dicht en of afdichtingen niet beschadigd zijn
	Het product bevindt zich in de nabijheid van een warmtebron of de luchtstroom naar de condensor wordt onderbroken	Verplaats de koelkast naar een geschiktere locatie
	Omgevingstemperatuur is te hoog	Verbeter de ventilatie of verplaats het product naar een koelere locatie
	Ongeschikte levensmiddelen worden in het product bewaard	Verwijder alle overbodige warme levensmiddelen of deblokkeer de ventilator
	Het product wordt overbelast	Verminder de hoeveelheid opgeslagen voedsel in het product
Het product lekt water	Het product staat niet recht	Pas de verstelbare poten aan om het product te nivelleren (indien nodig)
	De afvoeropening wordt geblokkeerd	Maak de afvoeropening vrij van obstakels
	De waterstroom naar de afvoer wordt geblokkeerd	Maak de vloer vrij van obstakels (indien nodig)
	De waterbak is beschadigd	Laat een technicus of een vaktechnicus komen
	De druppellade stroomt over	Leeg de druppellade (indien nodig)
Het product maakt ongebruikelijk veel lawaai	U heeft de veiligheidsband niet verwijderd	Verwijder de veiligheidsband
	Moer/schroef los	Alle moeren en schroeven controleren en aantrekken
	Het product is niet op een effen of stabiele ondergrond geplaatst	Installatielocatie controleren en indien nodig veranderen

Elektrische bedrading

De bedrading van dit apparaat is als volgt:

- Stroomkabel (bruin) naar de aansluitklem gemarkeerd met L
- Neutraalkabel (blauw) naar de aansluitklem gemarkeerd met N
- Aardekabel (groen/geel) naar de aansluitklem gemarkeerd met E

Dit apparaat moet worden geaard met behulp van een adequaat aardingscircuit.



Bij twijfels raadpleeg een vakkundige elektricien.

De elektrische isolatiepunten mogen niet worden geblokkeerd. In geval van een nooduitschakeling moeten de isolatiepunten direct toegankelijk zijn.

Afvalverwerking

De EU-richtlijnen vereisen dat koelproducten door gespecialiseerde bedrijven wordt verwerkt die gassen, metalen en plastic componenten verwijderen of recyclen.

Raadpleeg uw plaatselijke afvalverwerkingsbedrijf voor informatie over de afvalverwerking van uw apparaat. De plaatselijke overheden zijn niet verplicht om koelingsproducten van bedrijven als afval te verwerken maar kunnen uw informeren waar u het apparaat kunt afgeven.

U kunt ook de helplijn bellen voor informatie over landelijke afvalverwerkingsbedrijven in de EU.

Productconformiteit

Het WEEE-logo op dit product of bijbehorende documentatie geeft aan dat het product niet onder huisvuil valt en als zodanig ook niet mag worden verwerkt. Ter preventie van mogelijke gevaren voor de gezondheid van personen en/of voor het milieu, dient men dit product in overeenstemming met het voorgeschreven en milieuveilige recyclingproces als afval te verwerken. Raadpleeg uw productleverancier of uw plaatselijk afvalverwerkingsbedrijf voor meer informatie over de juiste afvalverwerking van dit product.



De onderdelen van producten hebben strenge producttesten ondergaan om te voldoen aan wettelijke regels en specificaties die door internationale, onafhankelijke en landelijke overheden worden voorgeschreven.



Producten zijn goedgekeurd en voorzien van het volgende symbool:

Conseils de sécurité

- Placez l'appareil sur une surface plane, stable.
- L'installation et les éventuelles réparations doivent être confiées à un dépanneur / technicien qualifié. Ne retirez aucun composant ou cache de ce produit.
- Consultez les normes locales et nationales pour vous conformer aux :
 - lois sur l'hygiène et la sécurité au travail ;
 - codes de bonnes pratiques EN ;
 - précautions contre le risque d'incendie ;
 - réglementations sur les branchements électriques IEE ;
 - règlements sur la construction.
- NE PAS nettoyer cet appareil avec un nettoyeur à jet / à pression.
- NE PAS se servir de cet appareil pour stocker des médicaments.
- NE PAS utiliser d'appareils électriques à l'intérieur de l'appareil (ex. chauffages, sorbetières, etc.)
- NE PAS se tenir debout sur le châssis, les tiroirs ou les portes ou s'y accouder.
- NE PAS éclabousser les composants en plastique ou les joints de porte d'huile ou de matières grasses. En cas d'éclaboussure, nettoyez immédiatement la surface touchée.
- Cet appareil est réservé exclusivement à une utilisation à l'intérieur.
- Les bouteilles qui contiennent un haut pourcentage d'alcool doivent être bouchonnées et rangées à la verticale dans le réfrigérateur.
- Veillez à toujours transporter, stocker et manipuler l'appareil à la verticale et à le déplacer en tenant la base du châssis.
- N'oubliez jamais d'éteindre et de débrancher l'appareil avant de procéder à son nettoyage.
- Gardez les emballages hors de portée des enfants. Débarrassez-vous des emballages conformément aux règlements des autorités locales.

- Un cordon d'alimentation endommagé doit être remplacé par un agent ou un technicien qualifié recommandé, pour éviter tout danger.



Attention Risque d'incendie

- Ne stockez pas de substances explosives telles que les aérosols avec un propulseur inflammable dans cet appareil.
- **Attention** : Restez à l'écart de l'obstruction de toutes les ouvertures de ventilation dans le boîtier de l'appareil ou dans la structure pour la construction en.
- **Attention** : Ne pas utiliser de dispositifs mécaniques ou autres moyens pour accélérer le processus de dégivrage, autre que le fabricant recommandé Ceux par.
- **Attention** : Ne pas endommager le circuit frigorifique.
- **Attention** : Ne pas utiliser d'appareils électriques à l'intérieur des compartiments de stockage des aliments de l'appareil, à moins qu'ils soient du type recommandé par le fabricant.

Introduction

Nous vous invitons à consacrer quelques instants à la lecture attentive de ce mode d'emploi. L'entretien et l'utilisation appropriés de cette machine vous permettront de tirer le meilleur de votre produit

Contenu de l'emballage

Les éléments suivants vous sont fournis de série :

- Réfrigérateur ou congélateur
- 2 clés
- 6 (simples) / 12 (doubles) supports de clayettes
- Trois (simples) / six (doubles) clayettes
- Plateau de récupération des eaux usées
- Mode d'emploi

Attache une grande importance à la qualité et au service et veille à fournir des produits en parfait état opérationnel, parfaitement intacts au moment de l'emballage.

Nous vous prions de contacter votre revendeur immédiatement si vous constatez un dommage quelconque survenu pendant le transport du produit.

Installation



Remarque : dans les cas où l'appareil a été stocké ou déplacé autrement qu'à la verticale, placez-le en position debout pendant environ 12 heures avant de vous en servir. En cas de doute, laissez l'appareil se reposer.

1. Sortez l'appareil de l'emballage. Veillez à bien retirer toute la pellicule et les revêtements de protection de toutes les surfaces.
2. Veillez à prévoir une distance de 20 cm entre l'appareil et les murs ou autres objets, pour laisser l'air circuler. Augmentez cette distance si l'obstacle est une source de chaleur.



Remarque : Avant de mettre l'appareil en service pour la première fois, nettoyez les clayettes et l'intérieur de l'appareil à l'eau savonneuse.

3. Bloquez les freins des roulettes de l'appareil, pour l'empêcher de bouger OU Mettez l'appareil de niveau en réglant les pieds à vis.

Retrait de la sangle de sécurité du compresseur

- Posé sur des rondelles en caoutchouc, le compresseur est situé sur le haut de l'appareil. Dans des conditions d'utilisation normales, le compresseur vibre.
- Pour éviter tout risque de détérioration suite à un excès de mouvement pendant le transport, une sangle de sécurité en inox, vissée au-dessus de l'appareil, cale le compresseur.
- Cette sangle de sécurité et les deux vis de fixation qui la relient à l'appareil, doivent être retirées de l'appareil avant sa mise en service.

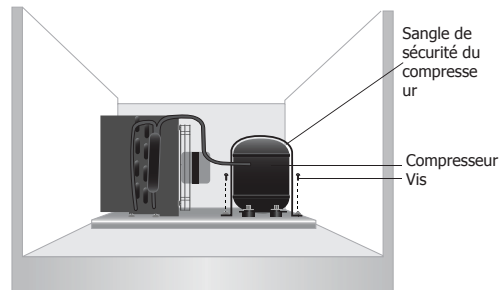

Verrouillage / déverrouillage des portes

Les portes sont munies d'un verrou qui vous permet d'enfermer les aliments dans votre appareil. Le verrouillage / déverrouillage de l'appareil s'effectue à l'aide des clés fournies.

Installation du plateau de récupération des eaux usées

Le plateau de récupération des eaux usées est livré prêt à installer sous l'appareil.

Faites glisser le plateau dans les coulisses situées sous l'appareil.

Installation des clayettes et des caches inférieurs

1. Placez une paire de supports de clayettes de part et d'autre de l'armoire, à la hauteur voulue.
2. Introduisez la clayette.
3. Répétez cette opération pour les autres clayettes.
4. Posez les caches inférieurs sur le plancher de l'armoire, en veillant à ce que le côté plat ne touche pas au sol.



Remarque : cette consigne est vitale pour assurer l'écoulement des résidus de condensation.

Fonctionnement

Stockage des aliments

Suivez ces consignes pour profiter au mieux de votre appareil :

- Ne stockez des aliments dans l'appareil lorsqu'il a atteint la bonne température de fonctionnement.
- Ne placez aucun aliment ou liquide chaud non couverts à l'intérieur de l'appareil.
- Autant que faire se peut, enveloppez ou couvrez les aliments.
- Veillez à ne pas obstruer les ventilateurs à l'intérieur de l'appareil.
- Evitez de laisser trop longtemps les portes ouvertes.

Mise en service

1. Vérifiez que l'interrupteur marche / arrêt est réglé sur [O] et allumez la prise.
2. Mettez l'appareil sous tension, position [I]. La température à l'intérieur de l'appareil s'affiche.

Panneau de configuration

Pour déverrouiller / verrouiller le clavier, appuyez sur ▲ et ▼ pendant 3 secondes.

L'affichage clignote PON (déverrouillé) / POF (verrouillé).

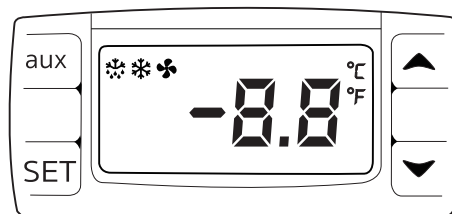

Réglez la température de fonctionnement

1. Appuyez sur le bouton **SET**. L'affichage clignote.
2. Appuyez sur les boutons ▲ ou ▼ pour afficher la température requise.
3. Appuyez sur le bouton **SET** pour mémoriser la température.

Dégivrage manuel

Appuyez sur le bouton «aux» et maintenez-le enfoncé pendant 2 secondes pour démarrer le dégivrage automatique. Le voyant de dégivrage s'allume.

Nettoyage, entretien et maintenance



Dégivrer les appareils au moins tous les trois mois, plus souvent si nécessaire.

N'oubliez jamais d'éteindre et de débrancher l'appareil avant de procéder à son nettoyage.

- Nettoyez l'intérieur de l'appareil aussi souvent que possible.
- N'utilisez aucun produit de nettoyage abrasif. Ces produits peuvent laisser des résidus nocifs.
- Le joint de porte ne se nettoie qu'à l'eau.
- Veillez à le sécher en l'essuyant après nettoyage.
- Ne laissez pas l'eau de nettoyage s'écouler à travers l'orifice de vidange du bac d'évaporation.
- Soyez prudent quand vous nettoyez l'arrière de l'appareil. Les bords effilés peuvent couper.
- Toute réparation doit être confiée à un agent ou à un technicien qualifié.

Entretien de l'inox

Veillez lire les informations suivantes sur l'entretien de l'extérieur en inox de votre appareil :

Ne jamais :

- Utiliser de tampons abrasifs, etc.
- Utiliser de détergents chlorés ou acides
- Laisser de saletés, de résidus alimentaires ou de produits chimiques de nettoyage sur la surface pendant de longues périodes. Les nettoyer immédiatement.
- Laisser la surface mouillée

À faire :

- Nettoyer souvent
- Utiliser des chiffons doux et des tampons en plastique
- Frotter dans le sens du grain du métal et non l'inverse
- Utiliser des détergents et produits d'entretien spécialement conçus pour l'inox
- Veiller à bien rincer les produits de nettoyage et à essuyer l'inox.

Entretien courant

Nettoyage du condensateur

- Le condensateur fait partie du système de réfrigération et doit être nettoyé tous les mois.
- Toujours débrancher la source d'alimentation afin de procéder à l'entretien courant.
- Un condensateur sale réduit les performances et la durée de vie de l'appareil et peut annuler la garantie.

Armoires verticales

Le condensateur se trouve dans l'armoire de réfrigération. Ces modèles sont équipés d'un filtre amovible qui peut être nettoyé à l'aide d'un aspirateur.

Armoires verticales

Le condensateur se trouve au dessus de l'armoire de réfrigération. Ces modèles sont équipés d'un filtre amovible qui peut être nettoyé à l'aide d'un aspirateur.

Dépannage

En cas de dysfonctionnement de votre appareil, vérifiez les données du tableau ci-dessous avant d'appeler notre standard d'assistance ou votre revendeur.

Dysfonctionnement	Cause probable	Intervention
L'appareil ne fonctionne pas	L'appareil n'est pas allumé	Vérifier que l'appareil est bien branché et allumé
	La prise et le cordon sont endommagés	Appeler un agent ou un technicien qualifié
	Alimentation	Vérifier l'alimentation
	Problème de branchement interne	Appeler un agent ou un technicien qualifié
L'appareil s'allume, mais la température est trop haute / basse	Excès de glace sur l'évaporateur	Décongeler l'appareil
	Le condensateur est saturé de poussières	Nettoyer le condenseur
	Les portes sont mal fermées	Vérifier que les portes sont fermées et l'état des joints
	L'appareil est situé près d'une source de chaleur ou l'air ne circule pas librement vers le condensateur	Déplacer le réfrigérateur pour le placer à un endroit mieux adapté
	Température ambiante trop haute	Augmenter la ventilation ou placer l'appareil à un endroit plus frais
	Des aliments inadéquats sont stockés dans l'appareil	Retirer les aliments trop chauds ou les éventuelles obstructions au ventilateur
Fuite d'eau	L'appareil n'est pas de niveau	Régler les pieds à vis pour le mettre de niveau (le cas échéant)
	Evacuation bouchée	Déboucher l'évacuation
	Circuit de vidange bouché	Nettoyer le plancher de l'appareil (le cas échéant)
	Bac à eau endommagé	Appeler un agent ou un technicien qualifié
	La cuvette de dégivrage déborde	Vider la cuvette de dégivrage (le cas échéant)
L'appareil fait beaucoup de bruit	La sangle de sécurité n'a pas été retirée	Retirer la sangle de sécurité
	Ecrou / vis desserrés	Vérifier et resserrer les écrous et vis
	La surface sur laquelle l'appareil a été posé n'est pas de niveau ou l'appareil n'est pas stable	Vérifier la position d'installation et la changer si nécessaire

Raccordement électrique

Cet appareil est câblé comme suit :

- Fil conducteur (brun) à la borne marquée L
- Fil neutre (bleu) à la borne marquée N
- Fil de terre (vert / jaune) à la borne marquée E

Cet appareil doit être raccordé à la terre, par le biais d'un circuit de mise à la terre dédié.



En cas de doute, consultez un électricien qualifié.

Les points d'isolation électrique doivent être libres de toute obstruction. En cas de débranchement requis en urgence, ils doivent être facilement accessibles.

Mise au rebut

Les règlements de l'UE exigent que les produits munis de réfrigérants soient mis au rebut par des entreprises spécialisées, équipées pour extraire et recycler les composants à gaz, métalliques et en plastique.

Adressez-vous à votre autorité chargée de la collecte des déchets pour ce qui concerne la mise au rebut de votre appareil. Même si rien n'oblige les autorités locales à se charger de la mise au rebut du matériel de réfrigération commerciale, elles pourraient être en mesure de vous conseiller sur les moyens disponibles localement pour s'en débarrasser.

Vous pouvez aussi appeler le standard d'assistance, qui saura vous renseigner sur les entreprises de prise en charge nationales au sein de l'UE.

Conformité

Le logo WEEE qui figure sur ce produit ou sa documentation indique qu'il ne doit pas être mis au rebut avec les ordures ménagères. Pour éviter qu'il ne présente un risque pour la santé humaine et / ou écologique, confiez la mise au rebut de ce produit à un site de recyclage agréé respectueux de l'environnement. Pour de plus amples détails sur la mise au rebut appropriée de ce produit, contactez le fournisseur du produit ou l'autorité responsable de l'enlèvement des ordures dans votre région.



Les pièces ont été soumises à des tests rigoureux pour pouvoir être déclarées conformes aux normes et spécifications réglementaires définies par les autorités internationales, indépendantes et fédérales.



Les produits ont été déclarés aptes à porter le symbole suivant :

Sicherheitshinweise

- Auf eine flache, stabile Fläche stellen.
- Alle erforderlichen Montage- und Reparaturarbeiten sollten von Wartungspersonal oder einem qualifizierten Techniker durchgeführt werden. Keine Bauteile oder Bedienflächen von diesem Produkt entfernen.
- Für folgende Normen und Vorschriften sind die lokalen und nationalen Normen heranzuziehen:
 - Arbeitsschutzvorschriften
 - EN Verhaltenspraktiken
 - Brandschutzvorschriften
 - IEE-Anschlussvorschriften
 - Bauvorschriften
- Das Gerät NICHT mit einem Strahl-/Hochdruckreiniger reinigen.
- Das Gerät NICHT zum Aufbewahren von medizinischen Produkten verwenden.
- KEINE Elektrogeräte im Gerät verwenden (wie Heizgeräte, Eiskremmaschinen usw.)
- NICHT auf den Schrank, die Schubladen oder Türen stellen.
- KEIN Öl oder Fett mit den Kunststoffteilen oder der Türdichtung in Kontakt kommen lassen. Bei Kontakt sofort reinigen.
- Nur zum Gebrauch in Gebäuden.
- Flaschen mit Alkohol in hoher Konzentration müssen dicht verschlossen und aufrecht stehend im Kühlschrank aufbewahrt werden.
- Das Gerät stets aufrecht tragen, lagern und transportieren. Zum Transport den Schrank an der Unterseite anfassen.
- Vor Reinigungsarbeiten stets zunächst das Gerät abschalten und den Netzstecker ziehen.
- Verpackungsmaterial außerhalb der Reichweite von Kindern aufbewahren und gemäß den lokalen Vorschriften entsorgen.

- Aus Sicherheitsgründen muss ein beschädigtes Stromkabel von einem Mitarbeiter oder empfohlenen qualifizierten Elektriker erneuert werden.



Vorsicht Gefahr von Feuer

- Explosive Stoffe wie Sprühdosen mit brennbaren Treibmittel in diesem Gerät nicht speichern.
- **Warnung:** Halten Sie immer saubergehalten werden alle Lüftungsöffnungen im Gerätegehäuse oder in der Struktur für den Einbau in.
- **Warnung:** Verwenden Sie keine mechanischen Vorrichtungen oder andere Mittel, um den Abtauvorgang zu beschleunigen, andere als die vom Hersteller empfohlen, die mit dem.
- **Warnung:** Halten Sie den Kältemittelkreislauf nicht beschädigen.
- **Warnung:** Verwenden Sie keine elektrischen Geräte innerhalb des Lebensmittellageraumes betreiben, sofern sie nicht der Typ, der vom Hersteller empfohlen wird.

Einführung

Bitte nehmen Sie sich einige Minuten Zeit und lesen Sie dieses Handbuch sorgfältig durch. Nur bei korrekter Wartung und vorschriftsgemäßem Betrieb kann Ihr Produkt optimale Leistung erzielen.

Lieferumfang

Folgende Teile befinden sich in der Verpackung:

- Kühl- oder Tiefkühlgerät
- 2 Schlüssel
- 6 Schienen (einfach) / 12 Doppelschienen
- Ablagen (einfach) / 6 Doppelablagen
- Wasserauffangschale
- Bedienungsanleitung

Ist stolz auf die hochwertige Qualität seiner Produkte und seinen erstklassigen Service. Wir stellen sicher, dass alle gelieferten Produkte zum Zeitpunkt der Verpackung voll funktionsfähig sind und sich in einwandfreiem Zustand befinden.

Sollten Sie Transportschäden feststellen, wenden Sie sich bitte unverzüglich an Ihren Händler.

Montage



Hinweis: Wenn das Gerät nicht aufrecht transportiert oder gelagert wurde, muss es vor Inbetriebnahme rund 12 Stunden aufrecht aufgestellt werden. Im Zweifelsfall lassen Sie es aufrecht stehen.

1. Gerät aus der Verpackung nehmen. Darauf achten, dass die gesamte Plastikfolie und alle Beschichtungen von sämtlichen Flächen entfernt wurden.
2. Zur Belüftung einen Abstand von 20 cm zwischen Gerät und Wänden oder anderen Objekten einhalten. Dieser Abstand muss größer sein, falls es sich bei dem Hindernis um eine Wärmequelle handelt.



Hinweis: Vor dem ersten Einsatz des Geräts die Ablagen und das Geräteinnere mit einer Seifenlauge reinigen.

3. Die Bremsen an den Laufrollen feststellen, damit sich der Schrank nicht bewegen kann. ODER Das Gerät durch Einstellen der Schraubfüße ausgleichen.

Entfernen des Kompressor-Sicherheitsriemens

- Der Kompressor befindet sich auf dem Gerät. Er ist durch Gummischeiben gepolstert. Bei normalen Betriebsbedingungen kann der Kompressor vibrieren.
- Um während des Transports Schäden durch zu starke Bewegung zu vermeiden, wird ein Edelstahl-Sicherheitsriemen über dem Kompressor gespannt und
- oben im Gerät festgeschraubt.
- Vor Einschalten des Geräts müssen der Sicherheitsriemen und die beiden Schrauben, mit denen der Riemen am Gerät befestigt ist, entfernt werden.

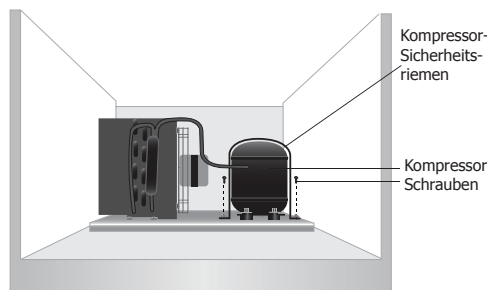

Ver-/Entriegeln der Türen

Um sicherzustellen, dass Nahrungsmittel in Ihrem Gerät sicher aufbewahrt werden, ist an den Türen ein Schloss angebracht.

Mit den Schlüsseln im Lieferumfang können Sie die Türen ver- bzw. entriegeln.

Anbringen der Wasserauffangschale

Die Wasserauffangschale kann im Nu an der Unterseite des Geräts befestigt werden.

Die Schale in die Laufschienen unter dem Gerät schieben.

Befestigen der Ablagen und Bodenschoner

1. Einen Satz Ablageschienen auf beiden Schrankseiten in der gewünschten Höhe platzieren.
2. Die Ablage einschieben.
3. Wiederholen Sie das Verfahren für die übrigen Ablagen.
4. Die Bodenschoner auf die untere Schrankfläche legen. Die flache Seite darf dabei den Boden nicht berühren.



Hinweis: Die richtige Positionierung ist wichtig, damit Kondenswasser korrekt ablaufen kann.

Betrieb

Lagerung von Nahrungsmitteln

Sie erzielen die besten Ergebnisse mit Ihrem Gerät, wenn Sie folgende Anweisungen beachten:

- Nahrungsmittel dürfen erst nach Erreichen der korrekten
- Betriebstemperatur im Gerät gelagert werden.
- Keine unbedeckten heißen Nahrungsmittel oder Flüssigkeiten in das Gerät legen oder stellen.
- Nahrungsmittel nach Möglichkeit einwickeln oder bedecken.
- Nicht die Lüfter im Gerät versperren.
- Türen nicht über längere Zeit geöffnet lassen.

Einschalten

1. Darauf achten, dass der Ein-/Ausschalter auf [O] steht und der Netzstecker eingesteckt ist.
2. Das Gerät einschalten [I]. Die momentane Temperatur im Gerät wird angezeigt.

Bedienfeld

Zum Entsperren / Sperren der Tastatur drücken Sie ▲ und ▼ zusammen für 3 Sekunden. Anzeige blinkt PON (entsperrt) / POF (gesperrt).

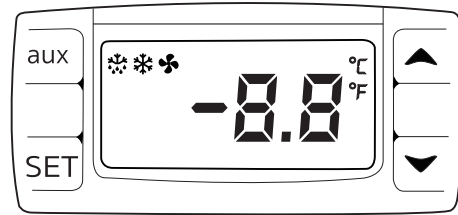

Betriebstemperatur einstellen

1. Die **SET**-Taste drücken. Die Anzeige blinkt auf.
2. Drücken Sie die Taste ▲ oder ▼, um die benötigte Temperatur aufzurufen.
3. Zum Speichern der Temperatur drücken Sie die Taste **SET**.

Manuelles Abtauen

Um den Abtauvorgang zu starten, die taste „aux“ 2 Sekunden lang gedrückt halten. Die Abtaulampe leuchtet auf.

Reinigung, Pflege und Wartung



Tauen Sie Geräte mindestens alle 3 Monate, bei Bedarf häufiger.

Vor Reinigungsarbeiten stets zunächst das Gerät abschalten und den Netzstecker ziehen.

- Den Schrank möglichst häufig innen reinigen.
- Keine Scheuermittel verwenden, da diese schädliche Rückstände hinterlassen können.
- Die Türdichtung nur mit Wasser reinigen.
- Nach dem Reinigen stets mit einem Tuch trocknen.
- Zur Reinigung verwendetes Wasser darf nicht durch die Ablauföffnung in die Auffangschale gelangen.
- Vorsicht beim Reinigen der Geräterückseite. Scharfe Kanten können zu Verletzungen führen.
- Erforderliche Reparaturen sollten von einem Mitarbeiter oder einem qualifizierten Techniker ausgeführt werden.

Pflegeanleitung für Edelstahl

Damit Ihr Produkt sein einwandfreies Edelstahlaussehen behält, beachten Sie bitte Folgendes:

Niemals:

- Scheuernde Topfkratzer, Scheuerschwämme usw. verwenden
- Chlor- oder säurehaltige Reinigungsmittel verwenden
- Artikel wie Nahrungsmittel, Schmutz, Reinigungschemikalien usw. länger als nötig auf der Oberfläche lassen; diese Stoffe sofort entfernen.
- Die Oberfläche nass bleiben lassen.

Unbedingt:

- Oft reinigen.
- Weiche Tücher oder Kunststoffkratzer verwenden.
- Mit der Metallmaserung reiben, nicht dagegen.
- Reinigungsmittel und eine Politur zur Reinigung von Edelstahl verwenden.
- Darauf achten, dass die Reinigungsprodukte vollständig abgewaschen werden und der Stahl anschließend trocken ist.

Routinewartung

Reinigung des Verflüssigers

- Der Verflüssiger ist Teil der Kühlanlage. Er muss jeden Monat gereinigt werden.
- Vor der Ausführung von Routinewartungsaufgaben stets das Gerät abschalten bzw. den Netzstecker ziehen.
- Wird der Verflüssiger nicht gereinigt, nehmen die Leistungsfähigkeit und Lebensdauer Ihres Geräts ab und Ihre Garantie kann erlöschen.

Aufrechte Schränke

Der Verflüssiger befindet sich unter dem Kühlschrank. Diese Modelle sind mit einem herausnehmbaren Filter ausgestattet, der mit einem Staubsauger gereinigt werden kann.

Aufrechte Schränke

Der Verflüssiger befindet sich über dem Kühlschrank. Diese Modelle sind mit einem herausnehmbaren Filter ausgestattet, der mit einem Staubsauger gereinigt werden kann.

Störungssuche

Bei einem Defekt Ihres Geräts konsultieren Sie bitte zunächst folgende Tabelle, bevor Sie die Helpline oder Ihren Händler anrufen.

Störung	Vermutliche Ursache	Lösung
Das Gerät funktioniert nicht	Das Gerät ist nicht eingeschaltet	Prüfen, ob der Netzstecker in die Steckdose gesteckt wurde und das Gerät eingeschaltet ist
	Stecker und Kabel sind beschädigt	Mitarbeiter oder qualifizierten Techniker anrufen
	Sicherung im Stecker ist durchgebrannt	Neue Sicherung in den Stecker einsetzen
	Stromzufuhr	Netzstrom prüfen
	Interner Vernetzungsfehler	Mitarbeiter oder qualifizierten Techniker anrufen
Das Gerät lässt sich einschalten, aber die Temperatur ist zu hoch/niedrig	Zu viel Eis auf dem Verdampfer	Das Gerät abtauen
	Kondensator verstaubt	Reinigen Sie den Kondensator
	Türen sind nicht richtig geschlossen	Prüfen, ob die Türen geschlossen und die Dichtungen intakt sind
	Gerät befindet sich in der Nähe einer Wärmequelle, oder der Luftstrom zum Kondensator ist unterbrochen	Den Kühlschrank an einem geeigneteren Ort aufstellen
	Umgebungstemperatur ist zu hoch	Belüftung intensivieren oder Gerät an einem kühleren Ort aufstellen
	Ungeeignete Nahrungs-mittel werden im Gerät aufbewahrt	Einige heiße Nahrungsmittel herausnehmen oder Produkte, die den Lüfter blockieren, entfernen
	Gerät ist überlastet	Weniger Nahrungsmittel im Gerät lagern
Aus dem Gerät läuft Wasser aus	Das Gerät steht nicht gerade	Die Schraubfüße so regulieren, dass das Gerät eben steht (sofern zutreffend)
	Der Ablauf ist verstopft	Den Ablauf säubern
	Wasser kann nicht ablaufen	Den Boden des Geräts von Fremdstoffen reinigen (sofern zutreffend)
	Der Wasserbehälter ist beschädigt	Mitarbeiter oder qualifizierten Techniker anrufen
	Die Tropfschale fließt über	Die Tropfschale leeren (sofern zutreffend)
Das Gerät ist ungewöhnlich laut	Der Sicherheitsriemen wurde nicht entfernt	Den Sicherheitsriemen entfernen
	Alle Muttern und Schrauben überprüfen und anziehen	Alle Muttern und Schrauben überprüfen und anziehen
	Das Gerät steht nicht eben oder stabil	Position überprüfen und bei Bedarf ändern

Elektroanschlüsse

Das Gerät ist wie folgt verdrahtet:

- Stromführender Leiter (braun) an Klemme L
- Neutralleiter (blau) an Klemme N
- Erdleiter (grün/gelb) an Klemme E



Das Gerät muss über eine spezielle Erdleitung geerdet werden.

Bei Fragen wenden Sie sich bitte an einen qualifizierten Elektriker.

Elektroisolierpunkte dürfen nicht blockiert werden. Bei einem Notstopp müssen diese Punkte jederzeit sofort zugänglich sein.

Entsorgung

Gemäß EU-Vorschriften müssen Kühlprodukte von Fachunternehmen entsorgt werden, die alle Gase, Metall- und Kunststoffbauteile entfernen oder recyceln.

Ihre Kommunalverwaltung kann Sie über die Entsorgung Ihres Geräts informieren. Kommunalbehörden sind nicht verpflichtet, gewerbliche Kühlgeräte zu entsorgen. Sie können Sie jedoch über lokale Annahmestellen informieren, die diese Geräte entsorgen.

Oder rufen Sie die Helpline an. Wir verfügen über eine Liste nationaler Entsorger in den EU-Staaten.

Konformität

Das WEEE-Logo an diesem Produkt oder in der Dokumentation weist darauf hin, dass das Produkt nicht mit dem normalen Hausmüll entsorgt werden darf. Um potenziellen Gesundheits- bzw. Umweltschäden vorzubeugen, muss das Produkt durch einen zugelassenen und umweltverträglichen Recyclingprozess entsorgt werden. Ausführliche Informationen zur korrekten Entsorgung dieses Produkts erhalten Sie von Ihrem Produktlieferanten oder der für die Müllentsorgung in Ihrer Region zuständige Behörde.



Alle Produkte werden strengen Tests unterzogen, um die Einhaltung von Normen und Spezifikationen internationaler und nationaler Behörden und unabhängiger Organisationen zu gewährleisten.

Produkte dürfen durch folgendes Symbol gekennzeichnet werden:



Suggerimenti per la sicurezza

- Posizionare il fabbricatore di ghiaccio su una superficie in piano e stabile.
- L'installazione e le eventuali riparazioni devono venire eseguite da un agente/tecnico qualificato. Non rimuovere i componenti o i pannelli di accesso dell'apparecchio.
- Verificare la conformità alle normative locali e nazionali di quanto segue:
 - Normativa antinfortunistica sul lavoro
 - Linee guida EN
 - Precauzioni antincendio
 - Normativa IEE sui circuiti elettrici
 - Norme di installazione
- NON utilizzare sistemi di lavaggio a getto o pressione per pulire l'apparecchio.
- NON utilizzare l'apparecchio per conservare presidi medico-sanitari.
- NON utilizzare apparecchiature elettriche all'interno dell'apparecchio (ad esempio, gelatiere, ecc.)
- NON stare in piedi o in altro sostenersi alla base, ai cassetti o ai portelli.
- NON mettere a contatto olio o grassi con i componenti in plastica o con la guarnizione dei portelli. Pulire immediatamente in caso di contatto.
- Per esclusivo uso in ambienti chiusi.
- Le bottiglie contenenti una elevata percentuale di alcool devono venire sigillate e posizionate verticalmente nel frigorifero.
- Trasportare, immagazzinare e movimentare l'apparecchio sempre in posizione verticale e spostarlo mantenendone la base.
- Spegner e disconnettere l'alimentazione dell'unità prima di pulirla.
- Tenere lontano l'imballaggio dalla portata dei bambini. Smaltire l'imballaggio in conformità alle normative locali.

- Se danneggiato, il cavo di alimentazione deve venire sostituito da un agente o da un tecnico qualificato al fine di prevenire eventuali rischi.



Attenzione Rischio di incendio

- Non conservare sostanze esplosive, come bombolette spray con propellente infiammabile in questo apparecchio.
- **Attenzione:** Mantenere libere da ostruzioni le aperture di ventilazione nel contenitore dell'apparecchio o nella struttura per l'incasso in.
- **Attenzione:** non utilizzare dispositivi meccanici o altri mezzi per accelerare il processo di sbrinamento, diversa dal fabbricante raccomandato Quelli da.
- **Attenzione:** Non danneggiare il circuito refrigerante.
- **Attenzione:** Non usare apparecchi elettrici all'interno degli scomparti per la conservazione degli alimenti, a meno che siano del tipo consigliato dal produttore.

Introduzione

Leggere con attenzione il presente manuale. La manutenzione e l'utilizzo corretti di questo apparecchio consentiranno di ottenere le massime prestazioni da questo prodotto.

Contenuto dell'imballaggio

L'imballaggio contiene quanto segue:

- Frigorifero o congelatore
- 2 chiavi
- Guide per ripiani 6x (singolo)/12x (doppio)
- Ripiani 3x (singolo)/6x (doppio)
- Manuale di istruzioni
- Vaschetta acqua reflua

Garantisce una qualità e un servizio impeccabili e assicura che al momento dell'imballaggio tutti i componenti forniti sono integralmente funzionanti e privi di difetti.

Nel caso siano rilevati danni risultanti dal trasporto del prodotto, rivolgersi immediatamente al rivenditore locale.

Installazione



Nota: se l'apparecchio è stato immagazzinato o spostato in posizione non verticale, lasciarlo in posizione verticale per circa 12 ore prima di metterlo in funzione. In caso di dubbio, osservare comunque questa precauzione.

1. Rimuovere l'apparecchio dall'imballaggio. Assicurarsi che la pellicola protettiva e rivestimenti in plastica siano interamente rimossi da tutte le superfici.
2. Osservare una distanza di 20 cm tra l'unità e le pareti o altri oggetti al fine di assicurare la necessaria ventilazione. Aumentare questa distanza se in prossimità di una sorgente di calore.



Nota: prima di utilizzare l'apparecchio per la prima volta, pulire i ripiani e l'interno dell'apparecchio con acqua saponata.

3. Innestare i freni delle ruote a sfera per mantenere l'apparecchio in posizione OPPURE Mettere in piano l'apparecchio regolando i piedi.

Rimozione della fascia di sicurezza del compressore

- Il compressore è posizionato nella parte superiore dell'apparecchio e riposa su rondelle in gomma. Il compressore vibra durante il normale funzionamento dell'apparecchio.
- Per evitare danni determinati da un eccessivo movimento durante il trasporto, una fascia di sicurezza in acciaio inossidabile viene posizionata sul compressore e quindi viene avvitata alla parte superiore dell'apparecchio.
- Rimuovere la fascia di sicurezza e le viti di fissaggio prima di accendere l'apparecchio.

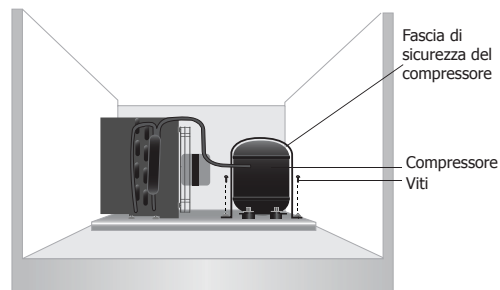

Blocco/sblocco dei portelli

Una serratura è montata sui portelli per assicurarsi che i cibi siano conservati al sicuro all'interno dell'apparecchio.

Utilizzare le chiavi fornite per bloccare/sbloccare i portelli.

Montaggio della vaschetta acqua reflua

La vaschetta dell'acqua reflua è pronta per essere montata nella parte inferiore dell'apparecchio.

Fare scivolare la vaschetta nelle guide situate sotto l'apparecchio.

Montaggio dei ripiani e delle protezioni pavimento

1. Posizionare un set di guide su ogni lato dell'armadio all'altezza desiderata.
2. Fare scivolare in posizione il ripiano.
3. Ripetere l'operazione per i ripiani rimanenti.
4. Posizionare le protezioni sul pavimento dell'armadio, assicurandosi che il lato piatto non sia a contatto con il pavimento.



Nota: il corretto montaggio è essenziale perché la condensa possa essere correttamente scaricata.

Funzionamento

Conservazione dei cibi

Per ottenere i migliori risultati dall'apparecchio, osservare le seguenti istruzioni:

- Conservare i cibi nell'apparecchio solo quando esso ha raggiunto la corretta temperatura di esercizio.
- Non conservare cibi o liquidi bollenti scoperti all'interno dell'apparecchio.
- Se possibile, avvolgere o coprire i cibi.
- Non ostruire le ventole all'interno dell'apparecchio.
- Evitare di aprire i portelli per periodi prolungati di tempo.

Accensione

1. Assicurarsi che l'interruttore dell'alimentazione sia impostato su [O] e acceso alla presa.
2. Accendere l'alimentazione [I]. Viene visualizzata la temperatura corrente all'interno dell'apparecchiatura.

Pannello di controllo

Per sbloccare / bloccare la tastiera premere ▲ e ▼ insieme per 3 secondi. Display lampeggia PON (sbloccato) / POF (bloccato).

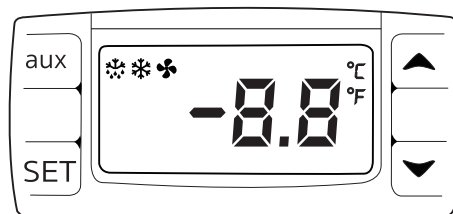

Impostazione della temperatura di esercizio

1. Premere il pulsante **SET**. Il display lampeggia.
2. Premere i pulsanti ▲ o ▼ per visualizzare la temperatura richiesta.
3. Premere il pulsante **SET** per memorizzare la temperatura.

Sbrinamento manuale

Premere senza rilasciare il pulsante "aux" per 2 secondi per avviare lo sbrinamento. La spia di sbrinamento si accende.

Pulizia e manutenzione



Sbrinare elettrodomestici almeno ogni tre mesi, più spesso se necessario.

Prima di eseguire la pulizia, spegnere e scollegare l'alimentazione.

- Pulire l'interno dell'apparecchio quanto più spesso possibile.
- Non utilizzare detergenti abrasivi in quanto possono lasciare residui nocivi.
- Pulire la guarnizione di tenuta dei portelli solo con acqua.
- Asciugare sempre dopo la pulizia.
- Non permettere che l'acqua utilizzata per la pulizia penetri attraverso il foro di scarico nella vasca di evaporazione.
- Prestare attenzione durante la pulizia della parte posteriore dell'apparecchio. Gli attrezzi con bordi taglienti possono provocare tagli.
- Le riparazioni devono venire eseguite da un tecnico qualificato o da un agente.

Istruzioni per la cura dell'acciaio inox

Per conservare l'aspetto esterno in acciaio inox del prodotto, osservare le seguenti indicazioni:

- Non usare mai pagliette di metallo o pagliette abrasive.
- Non usare mai detergenti acidi o clorurati.
- Non lasciare cibi, sporcizia o detergenti chimici sulla superficie più a lungo del necessario: rimuoverli immediatamente.
- Non lasciare la superficie bagnata o umida.

- Pulire frequentemente.
- Utilizzare panni morbidi o pagliette in plastica.
- Strofinare nel verso della satinatura e non al contrario.
- Utilizzare detergenti e lucidanti specifici per la pulizia dell'acciaio inox.
- Assicurarsi di sciacquare completamente i detergenti e che l'acciaio sia lasciato asciutto.

Manutenzione ordinaria

Pulizia del condensatore

- Il condensatore è un componente del sistema di refrigerazione. Il condensatore richiede una pulizia mensile.
- Scollegare sempre l'alimentazione prima di eseguire la manutenzione ordinaria.
- La mancata pulizia del condensatore riduce le prestazioni e la durata dell'unità e può invalidarne la garanzia.

Armadi verticali

Il condensatore è posizionato al di sotto dell'armadio refrigerante. I modelli sono dotati di un filtro rimovibile che è possibile pulire con un aspirapolvere.

Armadi verticali

Il condensatore è posizionato al di sopra dell'armadio refrigerante. I modelli sono dotati di un filtro rimovibile che è possibile pulire con un aspirapolvere.

Risoluzione dei problemi

Se dovessero verificarsi guasti dell'apparecchio, controllare la tabella seguente prima di contattare la helpline telefonica o il rivenditore.

Guasto	Probabile causa	Azione
L'apparecchio non funziona	L'apparecchio non è acceso	Controllare che l'apparecchio sia correttamente collegato e acceso
	La presa e il cavo sono danneggiati	Rivolgersi a un tecnico qualificato o a un agente
	Il fusibile della presa è guasto	Sostituire il fusibile della presa
	Alimentazione	Controllare l'alimentazione
	Guasto dei circuiti interni	Rivolgersi a un tecnico qualificato o a un agente
L'apparecchi si accende ma la temperatura è troppo alta o troppo bassa	Quantità eccessiva di ghiaccio nell'evaporatore	Sbrinare l'apparecchio
	Il condensatore è bloccato dalla polvere	Pulire il condensatore
	I portelli non sono chiusi in maniera appropriata	Controllare che i portelli siano chiusi e che le guarnizioni di tenuta non siano danneggiate
	L'apparecchio è posizionato in prossimità di una sorgente di calore oppure il flusso di aria al condensatore è interrotto	Spostare il frigorifero in una posizione più appropriata
	La temperatura ambientale è troppo alta	Aumentare la ventilazione oppure spostare l'apparecchio in una posizione più fresca
	Sono stati conservati nell'apparecchio cibi non appropriati	Rimuovere i cibi eccessivamente caldi o le ostruzioni della ventola
	L'apparecchio è sovraccarico	Ridurre la quantità dei cibi presenti nell'apparecchio
L'apparecchio perde acqua	L'apparecchio non è in posizione piana	Regolare i piedi al fine di mantenere in piano l'apparecchio (se pertinente)
	La bocca di scarico è bloccata	Pulire la bocca di scarico
	Il movimento dell'acqua verso lo scarico è ostruito	Pulire il pavimento dell'apparecchio (se pertinente)
	Il contenitore dell'acqua è danneggiato	Rivolgersi a un tecnico qualificato o a un agente
	La vaschetta di raccolta dell'acqua di sbrinamento è troppo piena	Svuotare la vaschetta di raccolta dell'acqua di sbrinamento (se pertinente)
L'apparecchio presenta una rumorosità eccessiva	La fascia di sicurezza non è stata rimossa	Rimuovere la fascia di sicurezza
	Dadi o viti allentati	Controllare e serrare tutti i dadi e le viti
	L'apparecchio non è stato installato in una posizione in piano o stabile	Controllare la posizione di installazione e modificarla se necessario

Cablaggi elettrici

L'apparecchio ha i seguenti cablaggi:

- Filo sotto tensione (colore marrone) a terminale L
- Filo del neutro (colore blu) a terminale N
- Filo di terra (colore verde/giallo) a terminale E

L'apparecchio deve avere un circuito dedicato di messa a terra.



In caso di dubbi, consultare un elettricista qualificato.

I punti di isolamento elettrico devono essere liberi da ostruzioni. In caso di emergenza, i punti devono essere facilmente raggiungibili qualora sia necessario scollegarli.

Smaltimento

Le normative UE prevedono che lo smaltimento dei prodotti di refrigerazione sia eseguito da aziende specializzate nella rimozione o nel riciclaggio di tutti i gas e dei componenti in metallo e plastica.

Rivolgersi all'ente locale incaricato per informazioni sullo smaltimento di questo apparecchio. Gli enti locali non hanno l'obbligo di procedere allo smaltimento di apparecchi di refrigerazione commerciali ma sono in grado di fornire suggerimenti sulla modalità di smaltimento di tali apparecchi.

In alternativa, chiamare la helpline telefonica di per ricevere informazioni dettagliate sulle aziende di smaltimento nella UE.

Conformità

Il logo WEEE riportato su questo prodotto o sulla relativa documentazione indica che il prodotto non può essere smaltito come normale rifiuto domestico. Per evitare possibili danni alla salute e/o all'ambiente, il prodotto deve venire smaltito utilizzando una procedura di riciclaggio approvata e sicura per l'ambiente. Per ulteriori informazioni su come smaltire in maniera corretta questo prodotto, contattare il fornitore del prodotto o l'ente locale responsabile per lo smaltimento dei rifiuti.



I componenti sono stati sottoposti a un rigoroso collaudo ai fini della conformità agli standard e alle specifiche normative previste dalle autorità internazionali, indipendenti e federali.

I prodotti sono autorizzati a esporre il seguente simbolo:



Consejos de Seguridad

- Colóquela sobre una superficie plana, estable.
- Un agente de servicio / técnico cualificado debería llevar a cabo la instalación y cualquier reparación si se precisa. No retire ningún componente ni panel de servicio de este producto.
- Consulte las Normas Locales y Nacionales correspondientes a lo siguiente:
 - Legislación de Seguridad e Higiene en el Trabajo
 - Códigos de Práctica EN
 - Precauciones contra Incendios
 - Normativos de Cableado de la IEE
 - Normativas de Construcción
- No utilice dispositivos de lavado de chorro / presión para limpiar el aparato.
- NO utilice este aparato para almacenar existencias médicas.
- NO utilice aparatos eléctricos en el interior del aparato (por ejemplo, calentadores, máquinas de hacer helados, etc.)
- NO se ponga de pie ni se apoye sobre la base, los cajones o las puertas.
- NO deje que el aceite o la grasa entren en contacto con los componentes de plástico o la junta de la puerta. Limpie el aparato inmediatamente si se produce contacto.
- Sólo adecuado para uso en interiores.
- Las botellas que contienen un alto porcentaje de alcohol deben sellarse y colocarse verticalmente en el frigorífico.
- Siempre debe transportar, almacenar y manipular el aparato verticalmente y moverlo cogiéndolo de la base.
- Desconecte la máquina y desenchúfela del suministro eléctrico de la unidad siempre antes de llevar a cabo la limpieza.
- Mantenga el embalaje lejos del alcance de los niños. Deshágase del embalaje de acuerdo con las normativas de las autoridades locales.

- Si el cable eléctrico está dañado, debe ser reemplazado por un agente de o un técnico cualificado recomendado para evitar cualquier riesgo.



Precaución Riesgo de Incendio

- No guarde sustancias explosivas, tales como latas de aerosol con un propelente inflamable en este aparato.
- **Advertencia:** Mantenga libres de obstrucción todas las aberturas de ventilación de la carcasa del aparato o en la estructura de edificio en.
- **Advertencia:** No utilice dispositivos mecánicos u otros medios para acelerar el proceso de descongelación, que no sea el fabricante recomienda Aquellos por.
- **Advertencia:** No dañe el circuito refrigerante.
- **Advertencia:** No utilice aparatos eléctricos dentro de los compartimentos de almacenamiento de alimentos del aparato, a menos que sean del tipo recomendado por el fabricante.

Introducción

Tómese unos minutos para leer este manual. El correcto mantenimiento y manejo de esta máquina proporcionará el mejor funcionamiento posible de su producto.

Contenido del Conjunto

Se incluye lo siguiente:

- Frigorífico o Congelador
- Llaves x 2
- Guías de estante x 6 (Sencillas) / x 12 (Dobles)
- Estantes x 3 (Sencillos) / x 6 (Dobles)
- Bandeja de agua residual
- Manual de instrucciones

Se enorgullece de su calidad y servicio y asegura que en el momento del embalaje, el contenido se suministró con plena funcionalidad y sin ningún defecto.

Si encontrara algún daño resultante del transporte, póngase en contacto inmediatamente con su distribuidor.

Instalación



Nota: Si el aparato no se ha almacenado o transportado en posición vertical, déjelo en posición vertical durante aproximadamente 12 horas antes del funcionamiento. Si tiene alguna duda, deje el aparato en posición vertical.

1. Desembale el aparato. Asegúrese de que todos los revestimientos y las láminas de plástico de protección se hayan quitado totalmente de todas las superficies.
2. Mantenga una distancia de 20 cm (7 pulgadas) entre la unidad y las paredes u otros objetos para ventilación. Aumente la distancia si el obstáculo es una fuente de calor.



Nota: antes de utilizar el aparato por primera vez, limpie los estantes y el interior con agua con jabón.

3. Coloque los frenos en las ruedecillas para mantener el aparato en su posición. O Nivele el aparato ajustando la pata enroscada.

Extracción de la Banda de Seguridad del Compresor

- El compresor se encuentra en la parte superior del aparato, y reposa sobre arandelas de goma. Bajo condiciones de funcionamiento normales, se permite que el compresor vibre.
- Para evitar los daños a través de un exceso de movimiento durante el transporte, se coloca una banda de seguridad de acero inoxidable sobre el compresor y se atornilla sobre el aparato.
- Esta banda de seguridad y los dos tornillos que la fijan al aparato deben retirarse antes de activar el aparato.

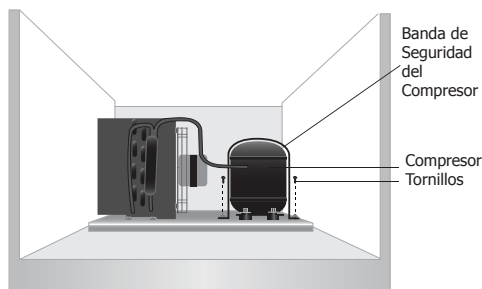

Abrir y cerrar las puertas con llave

Se incorpora una cerradura en las puertas para garantizar que los alimentos se mantengan seguros dentro de su aparato.

Utilice las llaves suministradas para abrir / cerrar las puertas.

Montaje de la Bandeja de Agua Residual

La bandeja de agua residual viene preparada para adaptarse al lado inferior del aparato.

Deslice la bandeja en los rieles situados debajo del aparato.

Montaje de las Protecciones de Suelo y los Estantes

1. Coloque un juego de guías de estante a cada lado de la cabina a la altura deseada.
2. Deslice el estante hasta su lugar.
3. Repita el proceso con los estantes restantes.
4. Coloque las protecciones de suelo en el suelo de la cabina, asegurándose de que el lado plano esté separado del suelo.



Nota: esto es vital para asegurar el desagüe completo de la condensación.

Funcionamiento

Almacenamiento de comida

Para obtener los mejores resultados de su aparato, siga estas instrucciones:

- Guarde alimentos en el aparato sólo cuando haya alcanzado la temperatura de funcionamiento correcta.
- No ponga comida ni líquidos calientes sin cubrir en el interior del aparato.
- Envuelva o cubra la comida siempre que sea posible.
- No obstruya los ventiladores en el interior del aparato.
- Evite la apertura de las puertas durante períodos de tiempo prolongados.

Activación

1. Asegúrese de que el interruptor de activación esté ajustado en [O] y conéctelo a la toma.
2. Conecte la Alimentación [I]. Se muestra la temperatura actual en el aparato.

Panel de Control

Para desbloquear / bloquear el teclado pulse ▲ y ▼ juntos por 3 segundos. La pantalla parpadeará PON (desbloqueado) / POF (bloqueado).

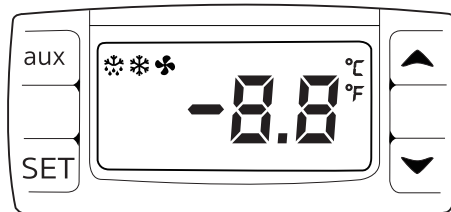

Ajuste de la Temperatura de Funcionamiento

1. Pulse el botón **SET**. El visualizador se enciende.
2. Pulse el botón ▲ o los botones ▼ para visualizar la temperatura deseada.
3. Pulse el botón **SET** para fijar la temperatura.

Descongelacion manual

Pulse y mantenga pulsado el boton "aux" durante 2 segundos para que empiece la descongelacion . La luz de descongelacion se iluminare.

Pulizia e manutenzione



Descongele los aparatos por lo menos cada 3 meses, con más frecuencia si es necesario.

Desconecte la máquina y desenchúfela de la toma eléctrica antes de llevar a cabo la limpieza.

- Limpie el interior del aparato con la mayor frecuencia posible.
- No utilice productos de limpieza abrasivos. Estos pueden dejar residuos nocivos.
- Limpie la junta de la puerta sólo con agua.
- Seque bien el aparato después de limpiarlo.
- No permita que el agua utilizada en la limpieza pase por el agujero de desagüe hacia el recipiente de evaporación.
- Vaya con cuidado al limpiar la parte trasera del aparato. Los bordes afilados pueden cortar.
- Un técnico cualificado o un agente de debe llevar a cabo las reparaciones en caso de precisarse.

Cuidado del acero inoxidable.

Para mantener el exterior del acero inoxidable de su unidad , por favor, considere la siguiente información:

Nunca:

- Utilice estropajos o esponjas de fregar abrasivas, etc.
- Utilice detergentes clorados o ácidos
- Deje nada, por ejemplo, sustancias químicas de limpieza, suciedad o comida sobre la superficie durante más tiempo de lo necesario. Límpielos inmediatamente.
- Deje que la superficie permanezca húmeda.

Siempre:

- Limpie con frecuencia.
- Utilice paños suaves o estropajos plásticos.
- Frote con la textura granular del metal más que a través de la misma.
- Utilice detergentes y ceras diseñados para la limpieza de acero inoxidable.
- Asegúrese de que los productos de limpieza se quiten por completo lavando y que el acero quede seco.

Mantenimiento de rutina

Limpieza del condensador

- El condensador es parte del sistema de refrigeración. El condensador requiere limpieza mensual.
- Desconecte siempre el suministro de alimentación antes de llevar a cabo el mantenimiento de rutina.
- La falta de limpieza del condensador reducirá su rendimiento y la vida útil de su unidad y puede invalidar su garantía.

Gabinetes verticales

El condensador está ubicado por debajo del gabinete de refrigeración. Estos modelos tienen un filtro extraíble que puede limpiarse con una aspiradora.

Gabinetes verticales

El condensador está ubicado por encima del gabinete de refrigeración. Estos modelos tienen un filtro extraíble que puede limpiarse con una aspiradora.

Resolución de problemas

Si su aparato falla, por favor compruebe la tabla siguiente antes de llamar a la línea de asistencia o a su distribuidor.

Fallo	Causa probable	Acción
El aparato no funciona	El aparato no está conectado	Compruebe que el aparato esté enchufado correctamente y conectado
	El enchufe y el cable están dañados	Llame a un técnico cualificado o a un agente de
	El fusible del enchufe se ha fundido	Cambie el fusible del enchufe
	Suministro eléctrico	Compruebe el suministro eléctrico
	Fallo del cableado interno	Llame a un técnico cualificado o a un agente de
El aparato se activa, pero la temperatura es demasiado alta / baja	Hay demasiado hielo en el evaporador	Descongele el aparato
	Condensador bloqueado con polvo	Limpie el condensador
	Las puertas no están bien cerradas	Compruebe que las puertas estén cerradas y las juntas no estén dañadas
	El aparato se encuentra cerca de una fuente de calor o el caudal de aire hacia el condensador está siendo interrumpido	Traslade el frigorífico a un lugar más adecuado
	La temperatura ambiente es demasiado alta	Aumente la ventilación o traslade el aparato a un lugar más fresco
	Se guardan alimentos no adecuados en el aparato	Retire cualquier exceso de alimentos calientes u obstrucciones del ventilador
	El aparato está sobrecargado	Reduzca la cantidad de alimentos guardados en el aparato
Hay fugas de agua en el aparato	El aparato no está bien nivelado	Ajuste las patas enroscadas para nivelar el aparato (si es aplicable)
	La salida de descarga está bloqueada	Limpie la salida de descarga
	El movimiento del agua hacia el desagüe está obstruido	Limpie la base del aparato (si es aplicable)
	El contenedor de agua está dañado	Llame a un técnico cualificado o a un agente de
	La bandeja de goteo está rebosando	Vacíe la bandeja de goteo (si es aplicable)
El aparato es inusualmente ruidoso	No se ha retirado la banda de seguridad	Retire la banda de seguridad
	Tuerca / tornillo flojo	Compruebe y apriete todos los tornillos y las tuercas
	El aparato no se ha instalado en una posición estable o nivelada	Compruebe la posición de la instalación y cámbiela si es necesario

Cableado Eléctrico

Este aparato está conectado de la forma siguiente:

- Cable cargado (de color marrón) al terminal marcado como L
- Cable neutro (de color azul) al terminal marcado como N
- Cable de tierra (de color verde / amarillo) al terminal marcado como E

El aparato debe estar conectado a tierra, utilizando un circuito de conexión a tierra especializado.



Si tiene alguna duda, consulte a un electricista cualificado.

Los puntos de aislamiento eléctrico deben mantenerse libres de cualquier obstrucción. En caso de precisarse una desconexión de emergencia, deben estar disponibles de forma inmediata.

Desecho

Las normativas de la UE requieren que los productos de refrigeración sean desechados por compañías especializadas que extraigan o reciclen todos los gases, componentes metálicos y de plástico.

Consulte a su autoridad local de recogida de residuos a la hora de desechar su aparato. Las autoridades locales no están obligadas a eliminar los equipos de refrigeración comerciales pero pueden ofrecer consejo sobre cómo desechar los equipos localmente.

Otra opción es llamar a la línea de asistencia de para pedir información sobre las compañías nacionales de desechos de la UE.

Cumplimiento

El logotipo WEEE en este producto o su documentación indica que no debe eliminarse como un residuo doméstico. Para ayudar a prevenir posibles daños a la salud humana y/ o el medio ambiente, el producto debe eliminarse en un proceso de reciclaje aprobado y medioambientalmente seguro. Para obtener más información sobre cómo eliminar correctamente este producto, póngase en contacto con el proveedor del mismo o la autoridad local responsable de la eliminación de residuos en su zona.



Las piezas han pasado estrictas pruebas de productos para cumplir las especificaciones y normas reguladoras establecidas por las autoridades internacionales, independientes y federales.



Los productos han sido autorizados para llevar el símbolo siguiente:

Conselhos de segurança

- Colocar numa superfície plana e estável.
- Um agente de serviço/técnico qualificado deverá efectuar a instalação e quaisquer reparações, caso necessário. Não retirar qualquer componente ou painéis de serviço deste produto.
- Consultar e cumprir os regulamentos locais e nacionais no que diz respeito à:
 - Legislação de saúde e segurança no local de trabalho
 - Códigos de trabalho
 - Prevenção de incêndios
 - Normas para sistemas eléctricos IEE
 - Código de construção
- NÃO utilizar máquinas de limpeza a pressão/jacto para limpar o produto.
- NÃO utilize este produto para armazenar acessórios médicos.
- NÃO utilizar aparelhos eléctricos no interior deste produto (como por exemplo máquinas de fazer gelados, etc.)
- NÃO se apoiar ou colocar em cima da base, das prateleiras ou das portas.
- NÃO permitir o contacto de óleo ou gordura com componentes de plástico ou guarnições das portas. Limpar imediatamente se tal acontecer.
- Apenas adequado para uso dentro de casa ou estabelecimentos.
- Fechar garrafas com uma elevada percentagem de álcool e colocá-las verticalmente no frigorífico.
- Este produto deve ser transportado, armazenado e manuseado em posição vertical. Transporte segurando o produto pela base.
- Deve-se sempre desligar o aparelho e retirar a ficha da tomada antes de fazer a limpeza.
- Mantenha o material da embalagem fora do alcance de crianças. O material da embalagem é para ser deitado fora respeitando as regras das autoridades locais.

- A fim de evitar situações perigosas, a substituição dos cabos de alimentação danificados deve ser feita por um agente ou um técnico qualificado recomendado.



Atenção Risco de Incêndio

- Não guarde substâncias explosivas, tais como: latas de aerossol com um propulsor inflamável no aparelho ESTA.
- **Aviso:** Mantenha-se afastado de obstrução todas as aberturas de ventilação do invólucro do aparelho ou na estrutura de edifício-in.
- **Aviso:** Não use dispositivos mecânicos ou outros meios para acelerar o processo de descongelação, distintos dos recomendados pelo fabricante.
- **Aviso:** Não danificar o circuito de refrigeração.
- **Aviso:** Não use aparelhos eléctricos no interior dos compartimentos de armazenamento de alimentos do aparelho, a menos que eles são o tipo recomendado pelo fabricante.

Introdução

Por favor utilize o tempo necessário para ler atentamente este manual. Uma manutenção e utilização correcta deste aparelho permitem a melhor capacidade de funcionamento do seu produto.

Conteúdo da embalagem

A embalagem inclui o seguinte:

- Frigorífico ou congelador da
- Chaves x 2
- Suportes de prateleiras x 6 (individuais)/ x 12 (duplas)
- Prateleiras x 3 (individuais)/ x 6 (duplas)
- Recipiente para água usada
- Manual de instruções

A orgulha-se pelo serviço e a qualidade dos seus produtos e portanto verifica, durante a fase de embalagem, o estado funcional e o bom estado do conteúdo fornecido.

Quando confrontado com quaisquer danos provocados durante o transporte, contacte imediatamente o seu fornecedor.

Instalação



Nota: se o aparelho foi armazenado ou transportado numa posição não igual à posição de instalação, deve-se, antes de utilizar o mesmo, colocar o produto durante 12 horas na posição de instalação. Em caso de dúvida deve cumprir a instrução anterior.

1. Retire o produto da embalagem. Verifique se retirou todas as tiras e camadas de protecção das superfícies do produto.
2. Para a ventilação adequada deve-se manter uma distância de 20cm entre o produto e as paredes ou outros objectos. Aumente esta distância se o objecto vizinho for uma fonte de calor.



Nota: Antes de utilizar o produto pela primeira vez deve limpar as prateleiras e o interior com água de sabão.

3. Aplique os travões para manter o produto no lugar OU ajuste os pés reguláveis para nivelar o produto.

Retirar a fita de segurança do compressor

- O compressor encontra-se na parte superior do produto e apoia-se em anilhas de borracha. Em condições normais de funcionamento é normal que o compressor vibre.
- Para evitar danos causados pelos movimentos durante o transporte, o compressor foi preso com uma fita de segurança de aço inoxidável e preso com parafusos na parte superior do produto.
- Antes de ligar o produto é necessário retirar esta fita de segurança e os dois parafusos.

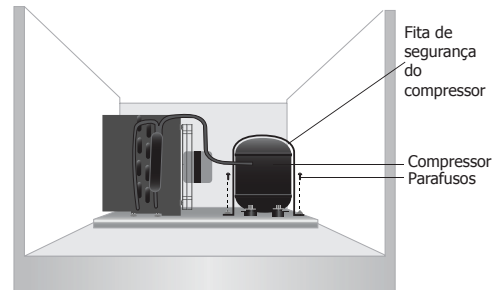

Fechar/abrir as portas

As portas foram equipadas com uma fechadura para guardar os alimentos com segurança no seu produto.

Utilize as chaves fornecidas para fechar/abrir as portas.

Colocar o recipiente para água usada

O recipiente para água usada cabe na parte inferior do produto.

Deslize o tabuleiro nos rolamentos por baixo do produto.

Colocar as prateleiras & rodapés

1. Coloque um par de suportes de prateleiras em ambos os lados do interior do produto e à altura desejada.
2. Coloque a prateleira no lugar.
3. Repetir esta instrução para colocar as outras prateleiras.
4. Coloque os rodapés no chão do produto, certificando-se de que o lado liso não toca o chão.



Nota: isto é muito importante para garantir uma drenagem correcta de condensação.

Funcionamento

Armazenamento de produtos alimentares

Siga as seguintes instruções para obter os melhores resultados do seu produto :

- Deve-se apenas guardar alimentos no produto quando este tiver atingido a temperatura de funcionamento correcta.
- Não coloque comida quente ou líquidos destapados no produto.
- Quando possível tape ou embrulhe a comida.
- Não bloquear os ventiladores no interior do produto.
- Evite deixar as portas abertas durante muito tempo.

Ligar

1. Controle se o interruptor principal está na posição [O] e coloque a ficha do produto na tomada.
2. Ligue o Power (alimentação) [I]. A temperatura interna do produto é indicada no painel indicador.

Painel de comando

Para bloquear / desbloquear o teclado, pressione ▲ e ▼ juntos durante 3 segundos.

Display piscará PON (desbloqueado) / POF (bloqueado).

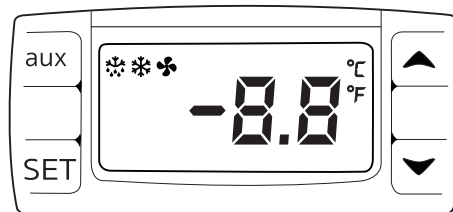

Seleccionar a temperatura de funcionamento

1. Carregue no botão **SET**. O visor começará a piscar.
2. Carregue no botão ▲ ou ▼ para aparecer no visor a temperatura desejada.
3. Carregue no botão **SET** para memorizar a temperatura.

Descongelação manual

Prima o botão "aux" durante seis segundos para iniciar a descongelação. A luz indicadora de descongelação acende-se.

Limpeza, cuidados & manutenção



Descongele aparelhos pelo menos a cada três meses, mais frequentemente, se necessário

Deve-se desligar o aparelho e retirar a ficha da tomada antes de fazer a limpeza.

- Limpe o interior do produto com a máxima frequência possível.
- Não utilizar produtos de limpeza abrasivos. Estes podem deixar resíduos prejudiciais.
- Limpe as guarnições da porta apenas com água.
- Secar totalmente depois da limpeza.
- Não permitir que água utilizada para a limpeza entre na panela de evaporação através da abertura de drenagem.
- Tenha cuidado ao limpar a parte de trás do produto. Os cantos afiados podem cortar.
- Um agente da ou técnico qualificado deverá efectuar quaisquer reparações, caso necessário.

Cuidado do aço inoxidável

Para manter o exterior em aço inoxidável do seu produto, tenha em conta as seguintes informações:

Nunca:

- Utilize esfregões abrasivos, etc.
- Utilize detergentes com cloro ou ácido
- Permita que algo, por exemplo, alimentos, sujidade, produtos químicos de limpeza, etc. permaneçam na superfície durante mais tempo que o necessário, limpe-os de imediato.
- Permita que a superfície esteja húmida.

Procedimento correto:

- Limpe com frequência.
- Utilize panos macios ou esfregões de plástico.
- Esfregue com a ponta de metal, em vez de o fazer na totalidade do mesmo.
- Utilize detergentes e polimentos concebidos para limpeza de aço inoxidável.
- Certifique-se de que os produtos de limpeza são totalmente lavados e que o aço fica seco.

Manutenção de rotina

Limpeza do condensador

- O condensador faz parte do sistema de refrigeração. O condensador deve ser limpo mensalmente.
- Desligue sempre a fonte de alimentação antes de efetuar a manutenção de rotina.
- Se o condensador não estiver limpo é reduzido o desempenho e a duração da unidade e pode invalidar a garantia.

Expositores verticais

O condensador está localizado abaixo do expositor de refrigeração. Estes modelos possuem um filtro removível que pode ser limpo com um aspirador.

Expositores verticais

O condensador está localizado acima do expositor de refrigeração. Estes modelos possuem um filtro removível que pode ser limpo com um aspirador.

Resolução de problemas

Se o seu produto apresentar uma falha, consulte a seguinte tabela antes de telefonar à linha de apoio ou ao seu agente.

Problema	Causa provável	A fazer
O aparelho não funciona	O aparelho não está ligado	Verifique a ligação correcta dos cabos e ligue o aparelho
	A ficha e o cabo estão danificados	Chame o agente da ou um técnico qualificado
	O fusível da ficha disparou	Substitua o fusível da ficha
	Fonte de alimentação	Verifique a fonte de alimentação
	Erro na cablagem interna	Chame o agente da ou um técnico qualificado
O produto liga mas a temperatura é demasiado alta ou baixa	Há muito gelo no evaporador	Descongele o produto
	O condensador está bloqueado por pó	Limpar o condensador
	As portas não estão totalmente fechadas	Verifique se as portas estão bem fechadas e se as guarnições estão danificadas
	O produto está perto de uma fonte de calor ou o fluxo de ar em direcção do condensador é interrompido	Desloque o frigorífico para um lugar mais adequado
	A temperatura ambiente é demasiado alta	Aumente a ventilação ou desloque o produto para uma posição mais fresca
	Está a guardar alimentos não adequados no produto	Retire quaisquer alimentos quentes ou alimentos que bloqueiem o ventilador
	O produto está sobrecarregado	Reduz a quantidade de alimentos armazenada no produto
Está a verter água do produto	O produto não está bem nivelado	Ajuste os pés reguláveis para nivelar o produto (caso necessário)
	A saída de descarga está bloqueada	Limpe a saída da descarga
	O movimento de água para a descarga está bloqueado	Limpe o chão do produto (caso aplicável)
	O recipiente de água está danificado	Chame o agente da ou um técnico qualificado
	O tabuleiro para gelo derretido (água) está a transbordar	Esvazie o tabuleiro (caso aplicável)
O produto produz mais ruídos do que o normal	Não retirou a fita de segurança	Retire a fita de segurança
	Desaperte a porca/parafuso	Verifique e aperte todos os parafusos e porcas
	O produto não foi instalado numa superfície nivelada ou estável	Verifique a posição da instalação e, caso necessário, desloque o produto

Cablagem eléctrica

O esquema de electricidade deste aparelho é o seguinte:

- Cabo eléctrico (castanho) para o terminal marcado L
- Cabo neutro (azul) para o terminal marcado N
- Cabo terra (verde/amarelo) para o terminal marcado com E

Este aparelho tem que estar ligado à terra através de um circuito de terra.



Consulte um electricista qualificado em caso de dúvidas.

Os pontos eléctricos isolados devem ficar limpos de qualquer obstrução. Estes pontos têm que ser imediatamente acessíveis caso seja necessário desligar a electricidade.

Tratamento de lixo e resíduos

Os regulamentos da UE exigem a entrega de produtos de refrigeração a empresas especializadas em remover ou reciclar todos os gases, metais e componentes de plástico.

Consulte a autoridade responsável pelo tratamento de lixo sobre a recolha do seu aparelho. As autoridades locais não são responsáveis pela recolha de equipamento comercial de refrigeração, no entanto, podem informá-lo quanto a recolha local do seu equipamento.

Ou então, contacte a linha de apoio da para obter informações sobre as empresas nacionais de tratamento de lixo na UE.

Conformidade

O logótipo WEEE neste produto ou a sua documentação indicam que o produto não deve ser tratado como lixo doméstico. Para ajudar a prevenir possíveis danos para a saúde humana e/ou ambiente, o produto deve ser eliminado de acordo com um processo de reciclagem aprovado e seguro para o ambiente. Para mais informação sobre como eliminar este produto correctamente, contacte o fornecedor do mesmo ou as autoridades locais responsáveis pela eliminação de desperdícios na sua área.



As componentes foram submetidas a testes rigorosos a fim de cumprirem as normas e especificações legais determinadas pelas autoridades internacionais, independentes e nacionais.



Os produtos foram aprovados e trazem o seguinte símbolo:



iJF

Electronic controller for food storage and display units



USER MANUAL

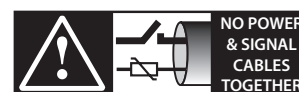

NO POWER
& SIGNAL
CABLES
TOGETHER

READ CAREFULLY IN THE TEXT!

iJF

+0300100EN - ENG

Up to date version available on

www.carel.com

GENERAL WARNINGS



CAREL bases the development of its products on decades of experience in HVAC, on continuous investments in technological innovations to products, procedures and strict quality processes with in-circuit and functional testing on 100% of its products, and on the most innovative production technology available on the market. CAREL and its subsidiaries/affiliates nonetheless cannot guarantee that all the aspects of the product and the software included with the product respond to the requirements of the final application, despite the product being developed according to start-of-the-art techniques. The customer (manufacturer, developer or installer of the final equipment) accepts all liability and risk relating to the configuration of the product in order to reach the expected results in relation to the specific final installation and/or equipment. CAREL may, based on specific agreements, act as a consultant for the successful commissioning of the final unit/application, however in no case does it accept liability for the correct operation of the final equipment/system. The CAREL product is a state-of-the-art product, whose operation is specified in the technical documentation supplied with the product or can be downloaded, even prior to purchase, from the website www.carel.com. Each CAREL product, in relation to its advanced level of technology, requires setup/configuration/programming/commissioning to be able to operate in the best possible way for the specific application. Failure to complete such operations, which are required/indicated in the user manual, may cause the final product to malfunction; CAREL accepts no liability in such cases. Only qualified personnel may install or carry out technical service on the product. The customer must only use the product in the manner described in the documentation relating to the product. In addition to observing any further warnings described in this manual, the following warnings must be heeded for all CAREL products:

- prevent the electronic circuits from getting wet. Rain, humidity and all types of liquids or condensate contain corrosive minerals that may damage the electronic circuits. In any case, the product should be used or stored in environments that comply with the temperature and humidity limits specified in the manual;
- do not install the device in particularly hot environments. Too high temperatures may reduce the life of electronic devices, damage them and deform or melt the plastic parts. In any case, the product should be used or stored in environments that comply with the temperature and humidity limits specified in the manual;
- do not attempt to open the device in any way other than described in the manual.
- do not drop, hit or shake the device, as the internal circuits and mechanisms may be irreparably damaged;
- do not use corrosive chemicals, solvents or aggressive detergents to clean the device;
- do not use the product for applications other than those specified in the technical manual.

All of the above suggestions likewise apply to the controllers, serial cards, programming keys or any other accessory in the CAREL product portfolio. CAREL adopts a policy of continual development. Consequently, CAREL reserves the right to make changes and improvements to any product described in this document without prior warning. The technical specifications shown in the manual may be changed without prior warning. The liability of CAREL in relation to its products is specified in the CAREL general contract conditions, available on the website www.carel.com and/or by specific agreements with customers; specifically, to the extent where allowed by applicable legislation, in no case will CAREL, its employees or subsidiaries/affiliates be liable for any lost earnings or sales, losses of data and information, costs of replacement goods or services, damage to things or people, downtime or any direct, indirect, incidental, actual, punitive, exemplary, special or consequential damage of any kind whatsoever, whether contractual, extra-contractual or due to negligence, or any other liabilities deriving from the installation, use or impossibility to use the product, even if CAREL or its subsidiaries/affiliates are warned of the possibility of such damage.

DISPOSAL

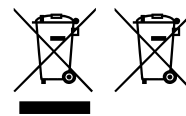
Fig. 1
Fig. 2

INFORMATION FOR USERS ON THE CORRECT HANDLING OF WASTE ELECTRICAL AND ELECTRONIC EQUIPMENT (WEEE)

The product is made up of metal parts and plastic parts. In reference to European Union directive 2002/96/EC issued on 27 January 2003 and related national legislation, please note that:

- WEEE cannot be disposed of as municipal waste and such waste must be collected and disposed of separately;
- the public or private waste collection systems defined by local legislation must be used. In addition, the equipment can be returned to the distributor at the end of its working life when buying new equipment;
- the equipment may contain hazardous substances: the improper use or incorrect disposal of such may have negative effects on human health and on the environment;
- the symbol (crossed-out wheeled bin) shown on the product or on the packaging and on the technical leaflet indicates that the equipment has been introduced onto the market after 13 August 2005 and that it must be disposed of separately;
- in the event of illegal disposal of electrical and electronic waste, the penalties are specified by local waste disposal legislation.

Warranty on materials: 2 years (from production date, excluding consumables).

Approval: the quality and safety of CAREL S.p.A. products are guaranteed by the ISO 9001 certified design and production system.



Separate as much as possible the probe and digital input cables from cables to inductive loads and power cables, so as to avoid possible electromagnetic disturbance. Never run power cables (including the electrical panel cables) and signal cables in the same conduits.

Key to the symbols:

- Caution:** to bring critical issues to the attention of those using the product.
- Notice:** to focus attention on important topics; in particular the practical application of the various product functions.
- Caution:** this product is to be integrated and/or incorporated into the final apparatus or equipment. Verification of conformity to the laws and technical standards in force in the country where the final apparatus or equipment will be operated is the manufacturer's responsibility. Before delivering the product, Carel has already completed the checks and tests required by the relevant European directives and harmonised standards, using a typical test setup, which however cannot be considered as representing all possible conditions of the final installation.

HACCP: CAUTION



Food Safety programs based on procedures such as HACCP and, more generally, certain national regulations, require that the devices used for food storage be periodically checked to ensure that measurement errors are within the limits allowed for the application used. Carel recommends users to follow, for example, the indications of the European standard "Temperature recorders and thermometers for the transport, storage and distribution of chilled, frozen, deep-frozen/quick-frozen food and ice cream - PERIODIC VERIFICATION"; EN 13486 - 2001 (or subsequent updates) or similar regulations and provisions in force in the country in question. Further information can be found in the manual regarding the technical characteristics, correct installation and configuration of the product.

Index

1. Introduction	7	7. Parameter table	84
1.1 Functions and main features.....	7	7.1 Parameter table.....	84
1.2 Models and accessories.....	8	7.2 Configuring the iJF controller via the Applica app.....	92
2. Installation	13	8. Technical specifications	94
2.1 Warnings.....	13	8.1 Connector/cable table.....	96
2.2 Small version for front panel mounting.....	13	9. Alarms and signals	97
2.3 Small version with SPLIT mounting.....	14	9.1 Signals.....	97
2.4 Large version for front panel mounting.....	16	9.2 Types of alarms.....	97
2.5 Large version with SPLIT mounting.....	17	9.3 Alarm table.....	98
2.6 Small version with remote HMI terminal.....	18	9.4 Low and high temperature alarms LO and HI.....	99
2.7 Large version with remote HMI terminal.....	20	9.5 HACCP alarms (HACCP = Hazard Analysis and Critical Control Point).....	100
2.8 Description of the terminals.....	21	9.6 Dirty condenser alarm.....	101
2.9 Probe connections.....	23	9.7 Frost protection alarm.....	101
2.10 Connection diagrams.....	24	9.8 Refrigerant leak alarm rSF.....	102
2.11 Positioning inside the panel.....	24	9.9 Maintenance alarm.....	102
2.12 Electrical installation.....	24	9.10 VCC compressor alarms with serial control.....	103
2.13 Serial port connections.....	25	10. Logs	104
2.14 Installation.....	25	10.1 Periodic logs.....	104
3. Configuration tools	26	10.2 Event log.....	104
3.1 Spark: configuration and commissioning software.....	26	11. Appendix	105
3.2 Sparkly: command-line configuration and commissioning software.....	26	11.1 ir33 and IJ parameter compatibility table.....	105
3.3 Applica app and Controlla.....	27	11.2 Input/output configuration procedure.....	107
3.4 Applica Desktop.....	27	11.3 Setting the default parameters/loading the parameter sets ...	108
4. User interface	28	11.4 Copy configuration parameters.....	109
4.1 Introduction.....	28	11.5 Preparing and using the configurations.....	109
4.2 Models with user terminal or remote HMI.....	29	12. Release notes	110
4.3 SPLIT models without user terminal.....	33		
5. Commissioning	34		
5.1 Description of the initial configuration parameters.....	34		
5.2 Set date/time and time bands.....	36		
5.3 Checks after commissioning.....	36		
6. Functions	37		
6.1 ON/OFF.....	37		
6.2 Inputs and outputs.....	38		
6.3 Digital inputs.....	40		
6.4 Analogue outputs.....	43		
6.5 Digital outputs.....	43		
6.6 Control.....	47		
6.7 Control modes.....	49		
6.8 Night-time operation.....	52		
6.9 ECO operation.....	53		
6.10 Continuous cycle.....	53		
6.11 Custom set points.....	54		
6.12 Compressor.....	54		
6.13 Compressor protection times.....	54		
6.14 Variable capacity compressor (VCC).....	55		
6.15 Pump down.....	60		
6.16 Defrost.....	61		
6.17 Evaporator fans.....	68		
6.18 Condenser fans.....	72		
6.19 Humidity management.....	74		
6.20 Light management.....	77		
6.21 Door management.....	77		
6.22 Door - light interactions.....	78		
6.23 Curtain management.....	78		
6.24 Generic functions.....	79		
6.25 Anti-sweat heater or fan.....	81		
6.26 Gasket heater.....	82		
6.27 Drain heater.....	82		
6.28 Temperature monitoring.....	83		
6.29 High and low voltage protection (HLVP).....	83		

1. INTRODUCTION

iJF is the range of CAREL electronic controls designed for commercial refrigeration food storage and display applications. The range comprises SMALL and LARGE formats, which differ in terms of the number of inputs/outputs and buttons available. Both formats allow different mounting methods: FRONT PANEL mounting with built-in display or SPLIT mounting, with or without REMOTE HMI DISPLAY. All models come with 115 - 230 Vac switching power supply and NFC (Near Field Communication) connectivity. All standard iJF display interfaces use backlit buttons with a capacitive touch screen.

A vast catalogue of options for integration into the device is available across the entire iJF range:

- Bluetooth to interact in real time with the chiller and access the data logs stored on the controller. Bluetooth antenna for connection to the Applica (service) and CONTROLLA apps (end user).
- Modbus over RS485 for connection to Carel or third-party supervisory systems (no external converter needed).
- VCC serial output to directly drive a VCC (variable capacity compressor) via serial link, without external adapters.
- Modulating outputs (0-10 V/PWM) to directly drive modulating loads such as frequency-controlled VCC compressors, dimmable lights or variable-speed fans.
- Humidity input to directly read a 0-5 V ratiometric humidity probe.
- Safety package with compressor protection against high and low power supply voltages (HLVP) and zero crossing function for the relays.
- RTC clock
- Different combinations of colours and keypads for the display.

The entire iJF range is integrated into the following CAREL support software and apps:

- Spark software for OEM technical departments; connection via RS485, BMS or port ID2 with specific converters.
- Applica Desktop software for OEM technical departments; connection via RS485, BMS or port ID2 with specific converters.
- Sparkly software for OEM production lines; connection via RS485.
- Applica app for technical service in the field; connection via NFC and BT.
- Controlla app for end users; connection via BT.

1.1 Functions and main features

The functions and most of the parameters available on the iJF range are mainly derived from the Carel ir33+ range. In addition to these, the following functions have been added:

- Read/write parameters via NFC (replacing the programming key).
- Temperature control in the dead band.
- Defrost drain heater.
- Fan cycles to avoid air stratification.
- Fan management for humidity levels (no dedicated probe needed).
- Door gasket heater.
- High and low power supply voltage detection.
- Refrigeration system failure alarm (rSF).

The iJF range has been designed to offer maximum flexibility through the use of modular hardware.

Main features of the basic versions:

- SMALL models, 4 inputs and up to 4 relays.
- LARGE models, 5 inputs and up to 6 relays.
- panel mounting with built-in display.
- split version with remote display.
- split version without remote display.
- 115-230 Vac $\pm 10\%$ (90-264 Vac) switching power supply.
- NFC connectivity.

Fully-integrated options:

- Bluetooth (with real time clock).
- Real time clock.
- 1 RS485 serial port for supervisor with Modbus protocol.
- 1 VCC serial port (*).
- 2 modulating outputs (0-10V/PWM/VCC by frequency) (*).
- 1 x 0-5 V ratiometric input (*).
- Compressor protection against high and low power supply voltages (HLVP) and zero crossing function for the relays.

(* versions are mutually exclusive

1.2 Models and accessories

Below are the features of the iJF models, divided by format and mounting.

Each product group can be identified based on the first 6 digits of the part number; please contact CAREL for the complete part numbers of the products available and the corresponding technical specifications.

1.2.1 SMALL controllers

FRONT PANEL mounting with built-in display



Fig. 1.a

P/N (first 6 digits)	Description
IJFPSA	<p>Basic features:</p> <ul style="list-style-type: none"> switching power supply, 115-230 Vac with high and low voltage detection; NFC; 2 probe inputs, 1 digital input, 1 multifunction input; max 4 relays (2HP 8A 5A 5A); removable, screw or fast-on terminals; single or multiple pack; black or white faceplate (*); white or red digits (*); 6 backlit touch buttons. <p>(*) Different colours available on custom models.</p> <p>Optional features:</p> <ul style="list-style-type: none"> Bluetooth with RTC; RTC; HLVP, ZC; 1 RS485 serial port for supervision. <p>Mutually-exclusive options:</p> <ul style="list-style-type: none"> 1 VCC serial port; 2 modulating outputs (0-10V/PWM/VCC by frequency, selectable for each output); 1 x 0-5 V ratiometric input; 1 RS485 Fieldbus serial port (secondary Modbus protocol only).

Tab. 1.a

SPLIT mounting



Fig. 1.b

P/N (first 6 digits)	Description
IJFSSA	<p>Basic features:</p> <ul style="list-style-type: none"> switching power supply, 115-230 Vac with high and low voltage detection; NFC; 2 probe inputs, 1 digital input, 1 multifunction input; max 4 relays (2HP 8A 5A 5A); removable, screw or faston terminals; single or multiple pack; JST connector at front for connection to remote display. <p>Optional features:</p> <ul style="list-style-type: none"> Bluetooth with RTC; RTC; HLVP, ZC; 1 RS485 serial port for supervision. <p>Mutually-exclusive options:</p> <ul style="list-style-type: none"> 1 VCC serial port; 2 modulating outputs (0-10V/PWM/VCC by frequency, selectable for each output); 1 x 0-5 V ratiometric input; 1 RS485 Fieldbus serial port (secondary Modbus protocol only).

Tab. 1.b

Remote HMI terminal



Fig. 1.c

P/N (first 6 digits)	Description
IJFHSA	<p>Basic features:</p> <ul style="list-style-type: none"> low voltage power supply from the controller; NFC; single or multiple pack; mini JST terminal for connection to the controller, fixed screw or removable; black or white faceplate (*); white or red digits (*); 6 backlit touch buttons. <p>(*) Different colours available on custom models.</p> <p>Optional features:</p> <ul style="list-style-type: none"> Bluetooth; 1 multifunction input, fixed screw or removable terminal.

Tab. 1.c

1.2.2 LARGE controllers

FRONT PANEL mounting with built-in display



Fig. 1.d

P/N (first 6 digits)	Description
IJFPLA	<p>Basic features:</p> <ul style="list-style-type: none"> switching power supply, 115-230 Vac with high and low voltage detection; NFC; 3 probe inputs, 1 digital input, 1 multifunction input; max 6 relays (2HP 16A 8A 8A 8A 8A or 30A 16A 8A 8A 8A 8A); removable, screw or faston terminals; single or multiple pack; black or white faceplate (*); white or red digits (*); 8 backlit touch buttons. <p>(* Different colours available on custom models.</p> <hr/> <p>Optional features:</p> <ul style="list-style-type: none"> Bluetooth with RTC; RTC; HLVP, ZC; 1 RS485 serial port for supervision. <hr/> <p>Mutually-exclusive options:</p> <ul style="list-style-type: none"> 1 VCC serial port; 2 modulating outputs (0-10V/PWM/VCC by frequency, selectable for each output); 1 x 0-5 V ratiometric input; 1 RS485 Fieldbus serial port (secondary Modbus protocol only).

Tab. 1.d

SPLIT mounting



Fig. 1.e

P/N (first 6 digits)	Description
IJFSLA	<p>Basic features:</p> <ul style="list-style-type: none"> switching power supply, 115-230 Vac with high and low voltage detection; NFC; 2 probe inputs, 1 digital input, 1 multifunction input; max 6 relays (2HP 16A 8A 8A 8A 8A or 30A 16A 8A 8A 8A 8A); removable, screw or faston terminals; single or multiple pack; JST terminal at front for connection to remote display. <hr/> <p>Optional features:</p> <ul style="list-style-type: none"> Bluetooth with RTC; RTC; HLVP, ZC; 1 RS485 serial port for supervision. <hr/> <p>Mutually-exclusive options:</p> <ul style="list-style-type: none"> 1 VCC serial port; 2 modulating outputs (0-10V/PWM/VCC by frequency, selectable for each output); 1 x 0-5 V ratiometric input; 1 RS485 Fieldbus serial port (secondary Modbus protocol only).

Tab. 1.e

Remote HMI terminal



Fig. 1.f

P/N (first 6 digits)	Description
IJFHLA	<p>Basic features:</p> <ul style="list-style-type: none"> • low voltage power supply from the controller; • NFC; • single or multiple pack; • JST terminal for connection to the controller, fixed screw or removable; • black or white faceplate (*); • white or red digits (*); • 8 backlit touch buttons. <p>(*): Different colours available on custom models.</p> <p>Optional features:</p> <ul style="list-style-type: none"> • Bluetooth; • 1 probe input, 1 digital input, 1 multifunction input, with fixed screw or removable terminals.

Tab. 1.f

1.2.3 Accessories

Notice: This list of ACCESSORY part numbers is updated as of the release date of this manual; please contact CAREL for any additional part numbers available.

Connector kit



Fig. 1.g

P/N	Description
BXOPZB35002B1	removable connector kit, 2-pin, 3.5 mm pitch, black (10 pcs)
BXOPZB35003B1	removable connector kit, 3-pin, 3.5 mm pitch, black (10 pcs)
BXOPZB38102G1	removable connector kit, 2-pin, 3.81 mm pitch, green (10 pcs)
BXOPZB38104G1	removable connector kit, 4-pin, 3.81 mm pitch, green (10 pcs)
BXOPZB38105G1	removable connector kit, 5-pin, 3.81 mm pitch, green (10 pcs)
BXOPZB50802O1	removable connector kit, 2-pin, 5.08 mm pitch, orange (10 pcs)
BXOPZB50803G1	removable connector kit, 3-pin, 5.08 mm pitch, green (10 pcs)
BXOPZB50805G1	removable connector kit, 5-pin, 5.08mm pitch, green (10 pcs)
BXOPZB50807G1	removable connector kit, 7-pin, 5.08 mm pitch, green (10 pcs)

Tab. 1.g

Fixing brackets



Fig. 1.h

P/N	Description
BXOPZMBRC0002	Built-in version panel bracket kit, multiple pack (20 pcs)
ACS00CK001602	panel bracket kit for HMI version multiple pack (20 pcs)

Tab. 1.h

Cables



Fig. 1.i

P/N	Description
BXOPZC3000050	3-wire cable jst mini/free end 50 cm (1 pc)
BXOPZC3S00250	3-wire cable jst mini/free end shielded 250 cm (1 pc)

Tab. 1.i

Cables for HMI display

Fig. 1.j

P/N	Description
BXOPZC4000150	4-wire cable jst mini/jst mini 150cm (1 pc)
BXOPZC4000300	4-wire cable jst mini/jst mini 300cm (1 pc)
BXOPZC4010300	4-wire cable jst mini/free end 300 cm (1 pc)

Tab. 1.j

Cables for VCC compressor inverters

Fig. 1.k

P/N	Description
BXOPZC30E0100	3-pin mini JST/free end shielded cable for Embraco inverter, 100 cm (1 pc)
BXOPZC30E0104	3-pin mini JST/free end shielded cable for Embraco inverter, 100 cm (40 pc)
BXOPZC30S0100	3-pin mini JST/free end shielded cable for Secop inverter, 100 cm (1 pc)

Tab. 1.k

Adapter kits

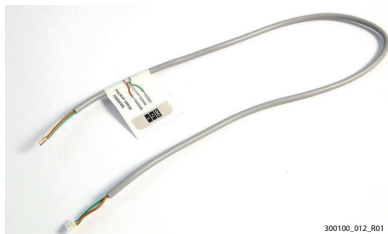
Fig. 1.l

P/N	Description
BXOPZC4020010	4-wire cable JST mini/removable adapter 10cm (1 pc)

Tab. 1.l

Converters

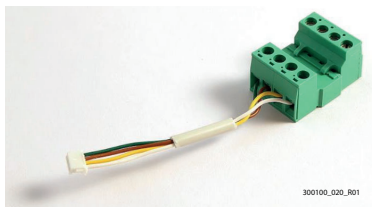
Fig. 1.m

P/N	Description
BXOPZIOWD0000	USB/1-wire converter for Digital Input (DI2)
BXOPZI4850000	RS485 converter for TTL serial port
CVSTDUMORO	USB/RS485 converter

Tab. 1.m

Gaskets

Fig. 1.n

P/N	Description
BXOPZMGKS0001	Gasket for rear mounting - Split Small (10 pcs)
BXOPZMGKI0001	Gasket for rear mounting - Split Large (10 pcs)

Tab. 1.n

1.2.4 Temperature sensors

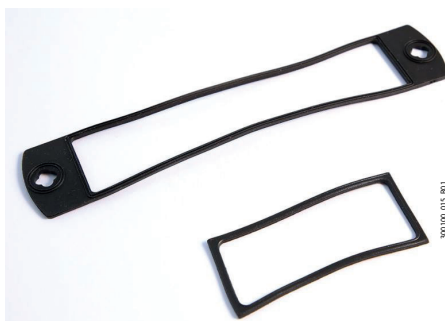

Fig. 1.o

P/N	Type	Description	Range
NTC***HP0*	10 kΩ±1%@25°C, IP67 β 3435	Temperature probe	-50 to 50°C (105°C in air)
NTC***HF01	10 kΩ±1%@25°C, IP67 β 3435	Evaporator outlet temperature probe	-50 to 90°C strap-on
PT1060HP01	PT1000 Class B, IP67	Temperature probe	-50T105°C in air
PT1***HF01	PT1000 Class B, IP67	Evaporator outlet temperature probe	50T105°C in air
DPRC*	NTC 10KΩ@25°C β3435 - 0...5 Vdc	Ambient temperature and humidity probe	-10T60°C - 10...90% U.R

Tab. 1.o

Notice: see manuals +040010025 (ITA- ENG) /+040010026 (FRE-GER) for guidelines on installing the sensors on the unit.

Installation example with one evaporator

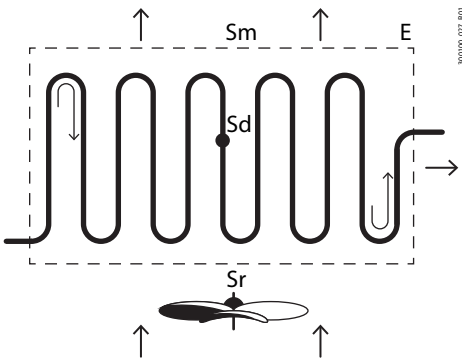

Fig. 1.p

Key:

P/N	Description
Sm	Outlet probe
Sr	Intake probe
Sd	Defrost probe
E	Evaporator

Tab. 1.p

2. INSTALLATION

2.1 Warnings

⚠ Caution: avoid installing the controller in environments with the following characteristics:

- temperature and humidity that do not comply with the ambient operating conditions (see "Technical specifications");
- strong vibrations or knocks;
- exposure to water sprays or condensate;
- exposure to aggressive and polluting atmospheres (e.g.: sulphur and ammonia gases, saline mist, smoke) which may cause corrosion and/or oxidation;
- strong magnetic and/or radio frequency interference (thus avoid installation near transmitting antennae);
- exposure to direct sunlight and the elements in general;
- wide and rapid fluctuations in ambient temperature;
- exposure of the controller to dust (formation of corrosive patina with possible oxidation and reduction of insulation);

2.2 Small version for front panel mounting

2.2.1 Dimensions mm (inch)

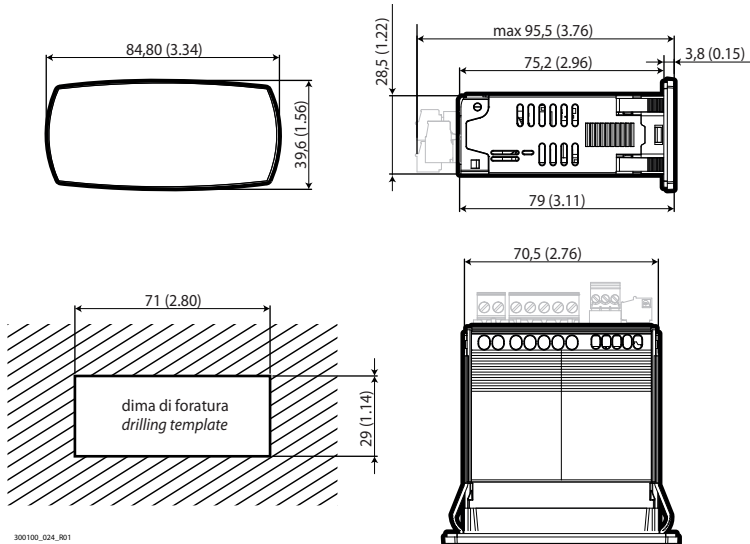

Fig. 2.a

2.2.2 Assembly

⚠ Caution: before carrying out any maintenance, disconnect the controller from the power supply by moving the main system switch to "off".

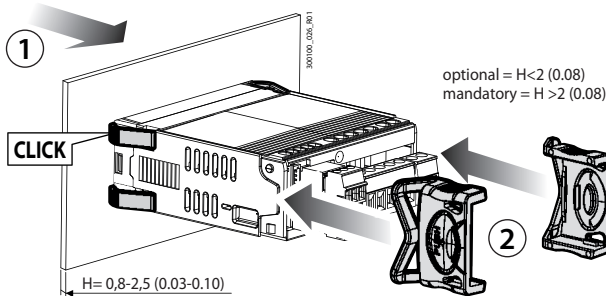

Fig. 2.b

1. Place the controller in the opening, pressing lightly on the side anchoring tabs.
2. Then press on the front until fully inserted (the side tabs will bend, and the catches will attach the controller to the panel, up to a maximum thickness of 2 mm).
3. If necessary, fit the fixing brackets.

⚠ Caution: IP65 front protection is guaranteed only if the following conditions are met:

- maximum deviation of the rectangular opening from flat surface: ≤ 0.5 mm (0.02 in);
- thickness of the electrical panel sheet metal: 0.8-2 mm (0.03-0.1 in); for thicknesses from 2-2.5 mm (0.08-0.10 in), the optional fixing brackets are required;
- maximum roughness of the surface where the gasket is applied: ≤ 120 μ m.

📌 Notice: the thickness of the sheet metal (or material) used to make the electrical panel must be adequate to ensure safe and stable mounting of the product (0.8-2.5 mm / 0.03-0.10 in).

2.2.3 Removal

⚠ Caution: before carrying out any maintenance, disconnect the controller from the power supply by moving the main system switch to "off".

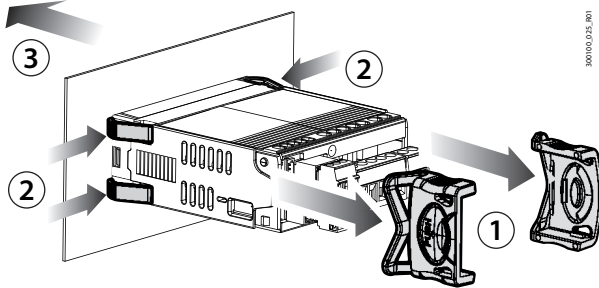

Fig. 2.c

Open the electrical panel and from the rear:

1. remove the fixing brackets (if fitted);
2. gently press the side anchoring tabs on the controller;
3. exert slight pressure on the controller until it is removed.

2.3 Small version with SPLIT mounting

2.3.1 Dimensions - mm (in)

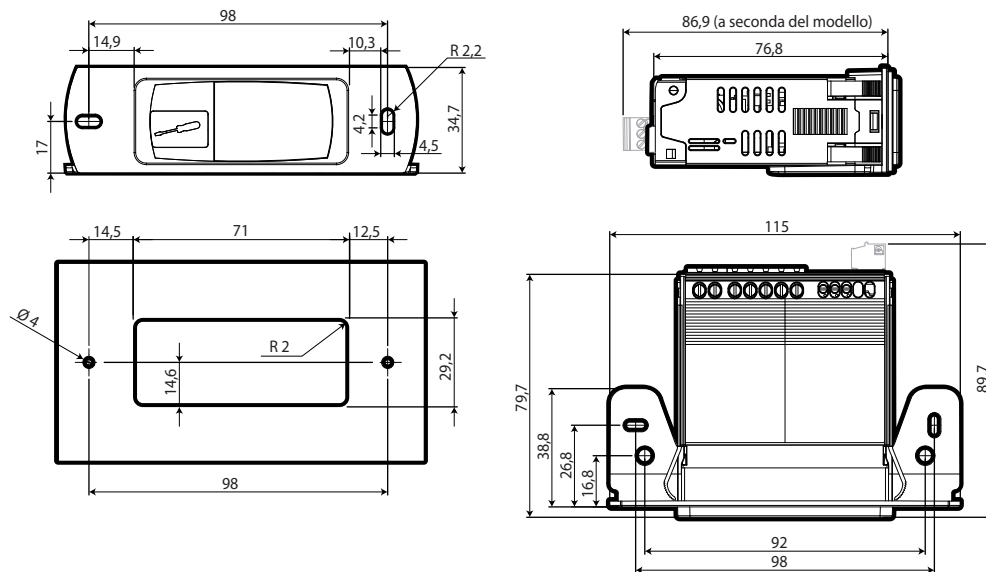

300100_036_R01

Fig. 2.d

2.3.2 Assembly

⚠ Caution: before carrying out any maintenance, disconnect the controller from the power supply by moving the main system switch to “off”.

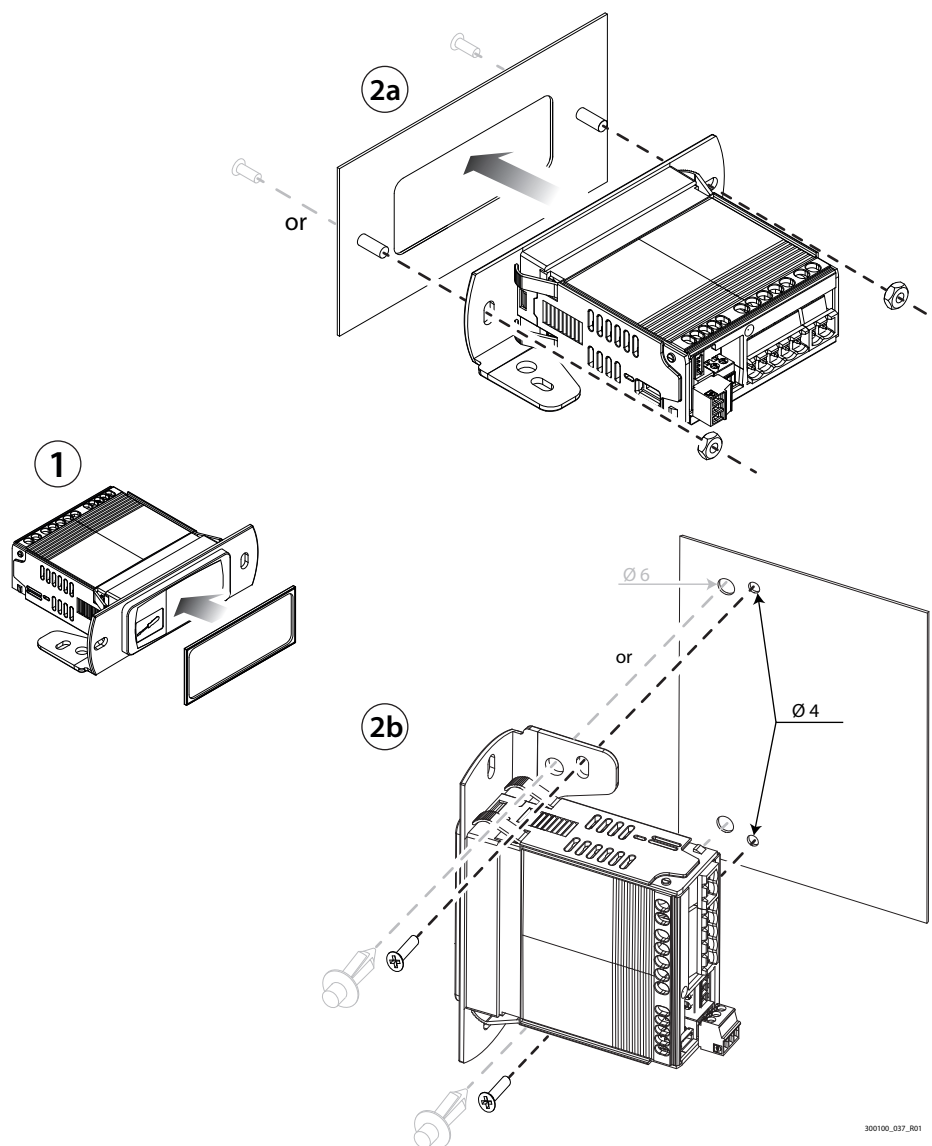

Fig. 2.e

1. Place the gasket on the front of the controller (for surface mounting only);
2. Place the controller over the drilling template or in the fixing position;
3. Tighten the fixing screws or insert the clips into the holes provided, as shown in the figure.

⚠ Caution: IP20 or IP45 front protection (with or without user interface connected, respectively) is guaranteed only if the following conditions are met:

- maximum deviation of the rectangular opening from flat surface: $\leq 0.5 \text{ mm}$ (0.02 in);
- maximum roughness of the surface where the gasket is applied: $\leq 120 \mu\text{m}$.

📌 Notice: the thickness of the sheet metal (or material) used to make the electrical panel must be adequate to ensure safe and stable mounting of the product (0.8-2.5 mm / 0.03-0.10 in).

2.3.3 Removal

⚠ Caution: before carrying out any maintenance, disconnect the controller from the power supply by moving the main system switch to “off”.

Open the electrical panel and from the rear:

1. unscrew the fixing screws or remove the clips.

2.4 Large version for front panel mounting

2.4.1 Dimensions - mm (in)

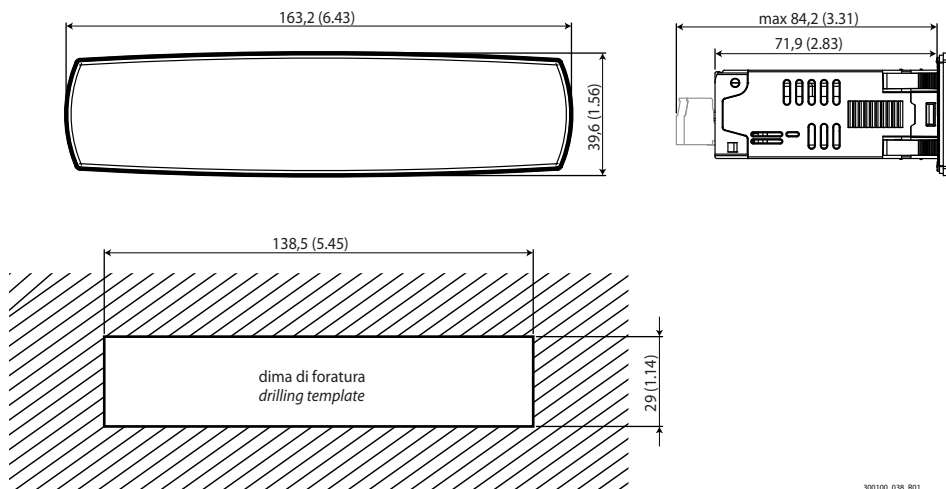

Fig. 2.f

2.4.2 Assembly

⚠ Caution: before carrying out any maintenance, disconnect the controller from the power supply by moving the main system switch to "off".

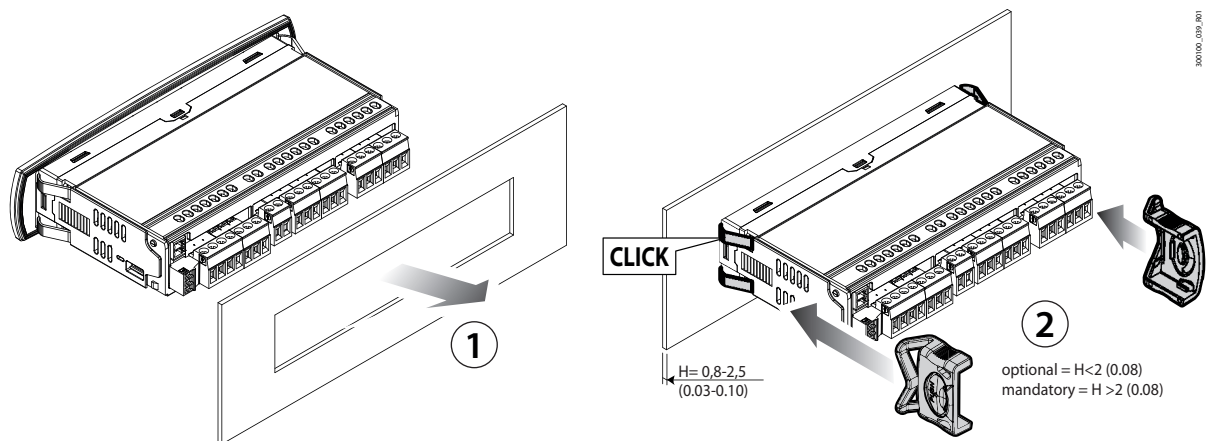

Fig. 2.g

1. Place the controller in the opening, pressing lightly on the side anchoring tabs.
2. Then press on the front until fully inserted (the side tabs will bend, and the catches will attach the controller to the panel, up to a maximum thickness of 2 mm).
3. If necessary, fit the fixing brackets.

⚠ Caution: IP65 or IP43 front protection (with or without fixing brackets, respectively) is guaranteed only if the following conditions are met:

- maximum deviation of the rectangular opening from flat surface: ≤ 0.5 mm (0.02 in);
- thickness of the electrical panel sheet metal: 0.8-2 mm (0.03-0.1 in); for thicknesses from 2-2.5 mm (0.08-0.10 in), the optional fixing brackets are required;
- maximum roughness of the surface where the gasket is applied: ≤ 120 μm .

📌 Notice: the thickness of the sheet metal (or material) used to make the electrical panel must be adequate to ensure safe and stable mounting of the product (0.8-2.5 mm / 0.03-0.10 in).

2.4.3 Removal

⚠ Caution: before carrying out any maintenance, disconnect the controller from the power supply by moving the main system switch to "off".

Open the electrical panel and from the rear:

1. remove the fixing brackets (if fitted);
2. gently press the side anchoring tabs on the controller;
3. exert slight pressure on the controller until it is removed.

2.5 Large version with SPLIT mounting

2.5.1 Dimensions - mm (in)

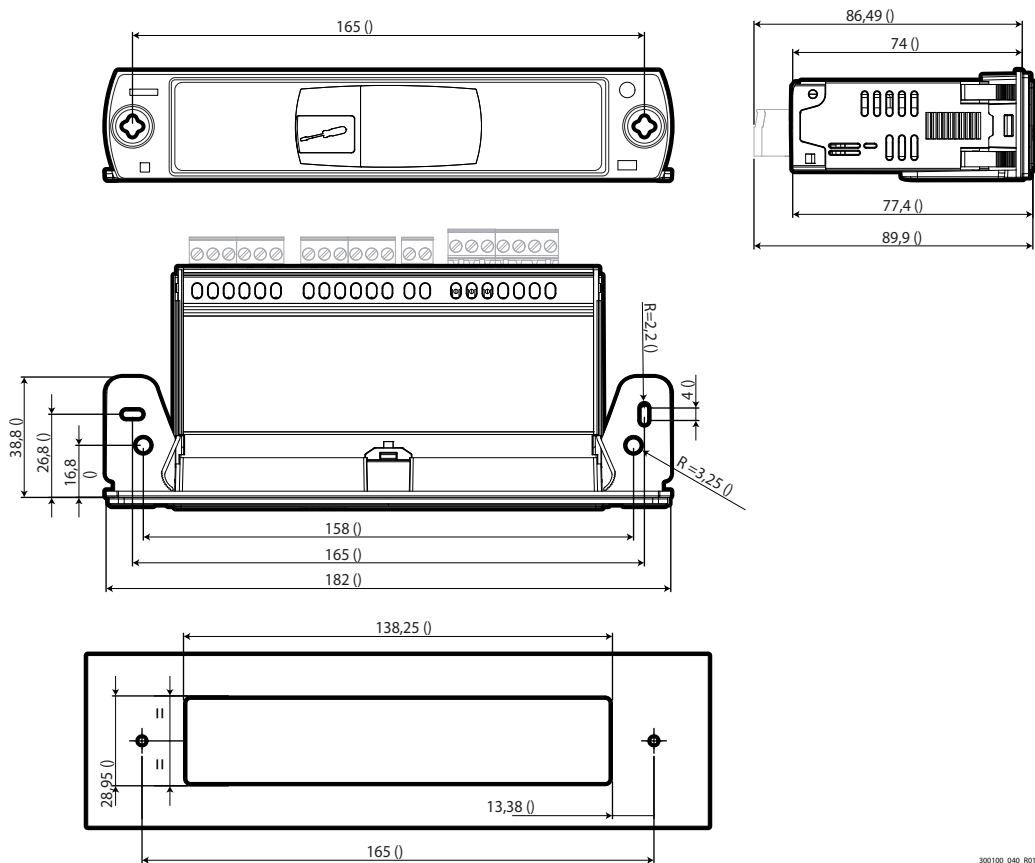

Fig. 2.h

300100_040_R01

2.5.2 Assembly

⚠ Caution: before carrying out any maintenance, disconnect the controller from the power supply by moving the main system switch to "off".

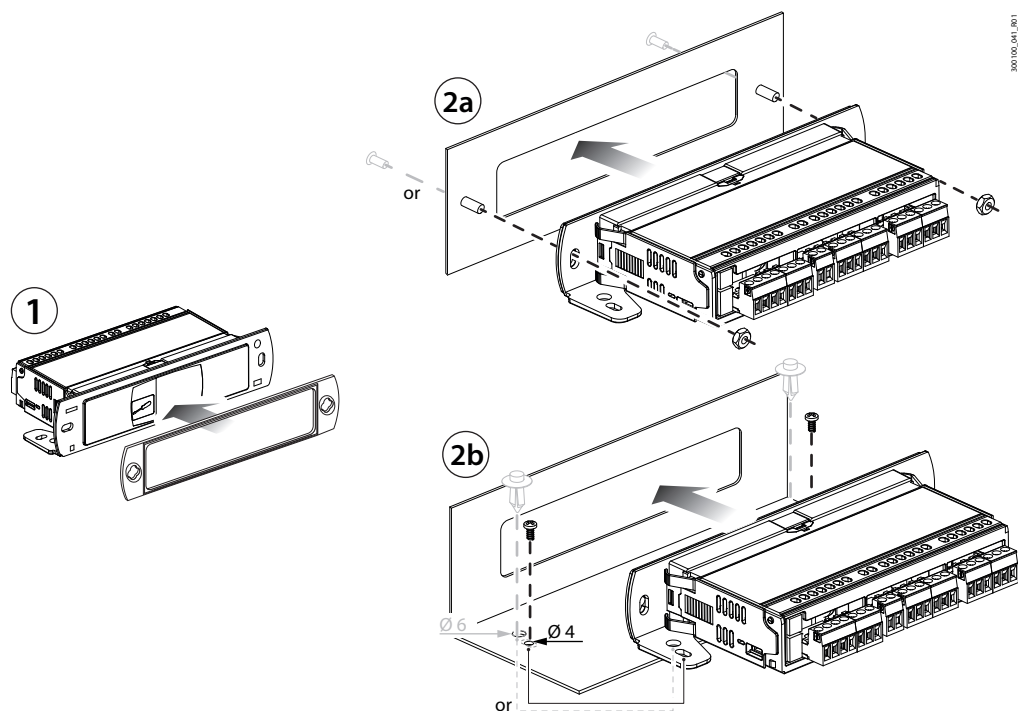

Fig. 2.i

300100_041_R01

1. Place the gasket on the front of the controller (for surface mounting only);
2. Place the controller over the drilling template or in the fixing position;
3. Tighten the fixing screws or insert the clips into the holes provided, as shown in the figure.

⚠ Caution: IP20 or IP45 front protection (with or without user interface connected, respectively) is guaranteed only if the following conditions are met:
 Maximum deviation of the rectangular opening from flat surface: $\leq 0.5 \text{ mm}$ (0.02 in);
 Maximum roughness of the surface where the gasket is applied: $\leq 120 \mu\text{m}$.

📌 Notice: the thickness of the sheet metal (or material) used to make the electrical panel must be adequate to ensure safe and stable mounting of the product (0.8-2.5 mm / 0.03-0.10 in).

2.5.3 Removal

⚠ Caution: before carrying out any maintenance, disconnect the controller from the power supply by moving the main system switch to "off".

Open the electrical panel and from the rear:

1. unscrew the fixing screws or remove the clips.

2.6 Small version with remote HMI terminal

2.6.1 Dimensions - mm (in)

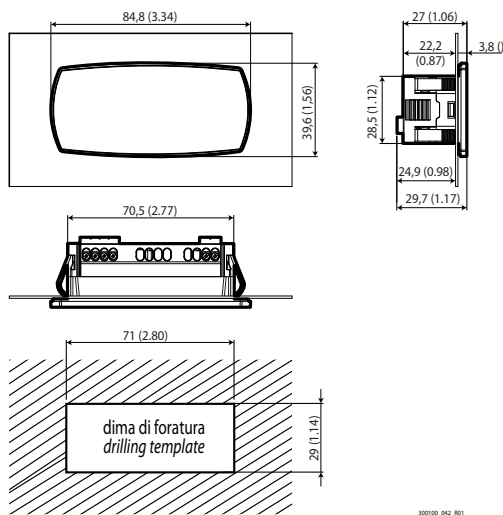

Fig. 2.j

2.6.2 Assembly

⚠ Caution: before carrying out any maintenance, disconnect the controller from the power supply by moving the main system switch to "off".

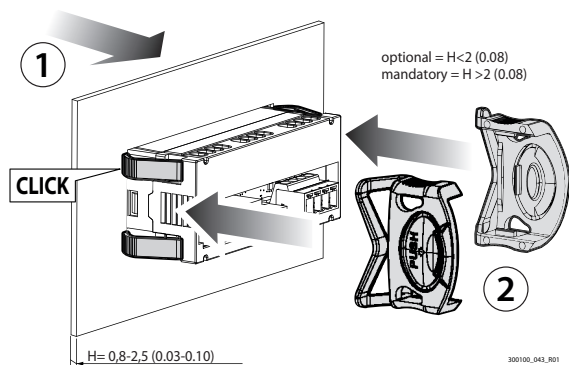

Fig. 2.k

1. Place the controller in the opening, pressing lightly on the side anchoring tabs.
2. Then press on the front until fully inserted (the side tabs will bend, and the catches will attach the controller to the panel, up to a maximum thickness of 2 mm).
3. If necessary, fit the fixing brackets.

⚠ Caution: IP65 front protection is guaranteed only if the following conditions are met:
 Maximum deviation of the rectangular opening from flat surface: ≤ 0.5 mm (0.02 in);
 Thickness of the electrical panel sheet metal: 0.8-2 mm (0.03-0.1 in); for thicknesses from 2-2.5 mm (0.08-0.10 in), the optional fixing brackets are required;
 Maximum roughness of the surface where the gasket is applied: ≤ 120 µm.

📌 Notice: the thickness of the sheet metal (or material) used to make the electrical panel must be adequate to ensure safe and stable mounting of the product (0.8-2.5 mm / 0.03-0.10 in).

2.6.3 Removal

⚠ Caution: before carrying out any maintenance, disconnect the controller from the power supply by moving the main system switch to "off".

Open the electrical panel and from the rear:

1. remove the fixing brackets (if fitted);
2. gently press the side anchoring tabs on the controller;
3. exert slight pressure on the controller until it is removed.

2.6.4 HMI connection

⚠ Caution: disconnect the controller before carrying out any maintenance.

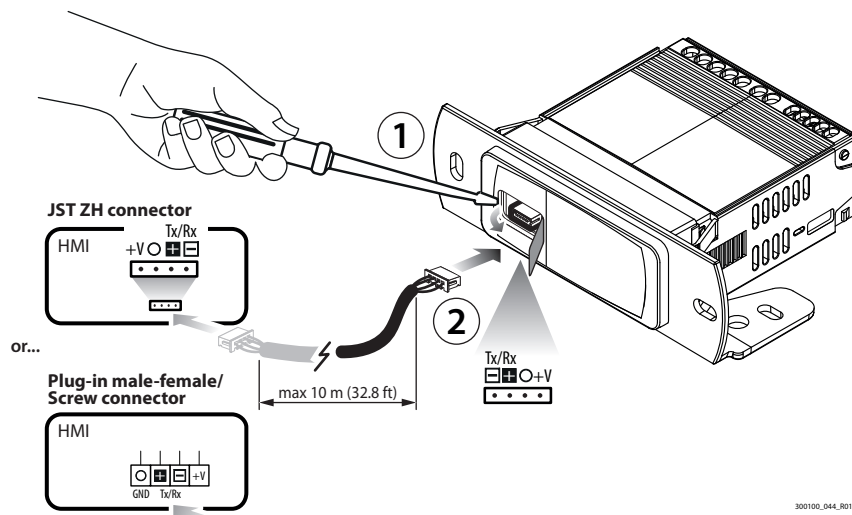

Fig. 2.1

Open the electrical panel and from the rear:

1. using a screwdriver, remove the rubber protection from the front of the Split controller;
2. connect the 4-wire cable to the mini JST connector on the controller;
3. connect the 4-wire cable to the mini JST or screw/removable connector on the user interface.

⚠ Caution: for HMIs with screw or removable terminals, respect the order of the wiring.

📌 Notice: see "Introduction" for the cable part numbers.

2.7 Large version with remote HMI terminal

2.7.1 Dimensions - mm (in)

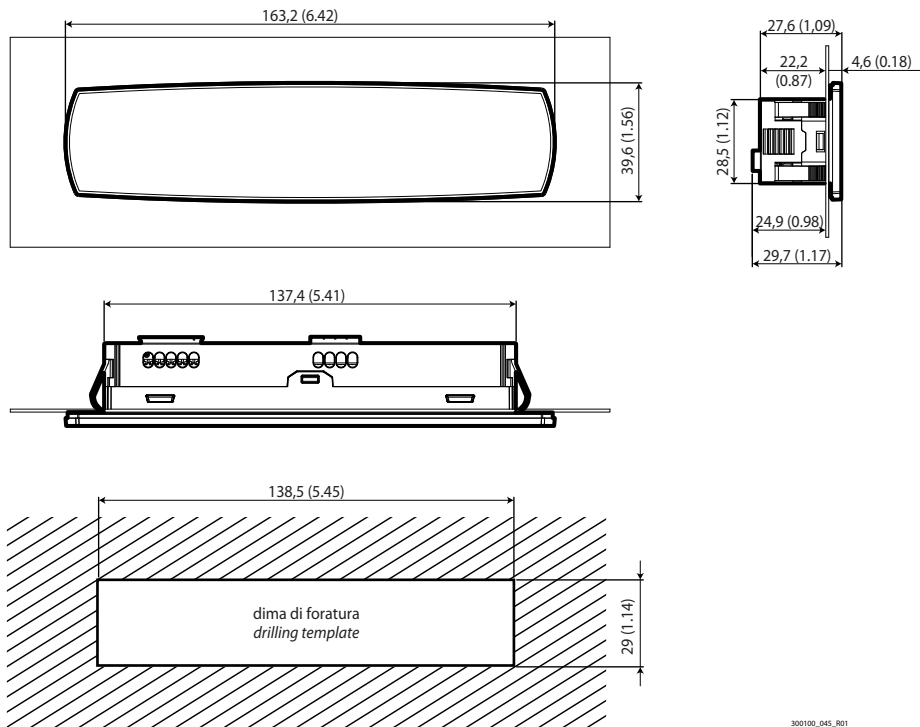

Fig. 2.m

2.7.2 Assembly

⚠ Caution: before carrying out any maintenance, disconnect the controller from the power supply by moving the main system switch to "off".

1. Place the controller in the opening, pressing lightly on the side anchoring tabs.
2. Then press on the front until fully inserted (the side tabs will bend, and the catches will attach the controller to the panel, up to a maximum thickness of 2 mm).
3. If necessary, fit the fixing brackets.

⚠ Caution: IP65 or IP43 front protection (with or without fixing brackets, respectively) is guaranteed only if the following conditions are met:

- maximum deviation of the rectangular opening from flat surface: ≤ 0.5 mm (0.02 in);
- thickness of the electrical panel sheet metal: 0.8-2 mm (0.03-0.1 in); for thicknesses from 2-2.5 mm (0.08-0.10 in), the optional fixing brackets are required;
- maximum roughness of the surface where the gasket is applied: ≤ 120 μm .

🔍 Notice: the thickness of the sheet metal (or material) used to make the electrical panel must be adequate to ensure safe and stable mounting of the product (0.8-2.5 mm / 0.03-0.10 in).

2.7.3 Removal

⚠ Caution: before carrying out any maintenance, disconnect the controller from the power supply by moving the main system switch to "off".

Open the electrical panel and from the rear:

1. remove the fixing brackets (if fitted);
2. gently press the side anchoring tabs on the controller;
3. exert slight pressure on the controller until it is removed.

2.7.4 Remote HMI terminal connection

⚠ Caution: before carrying out any maintenance, disconnect the controller from the power supply by moving the main system switch to “off”.

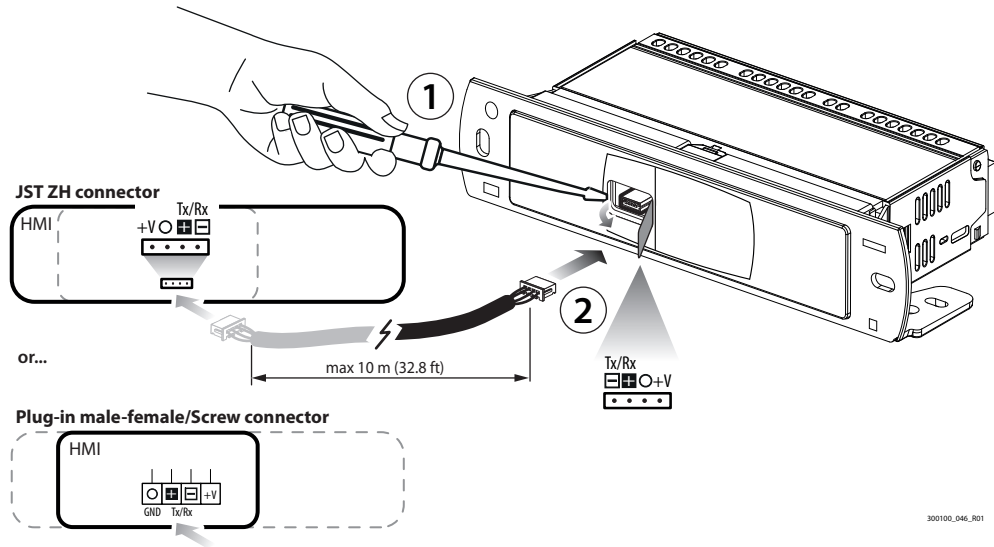

Fig. 2.n

Open the electrical panel and from the rear:

1. using a screwdriver, remove the rubber protection from the front of the Split controller;
2. connect the 4-wire cable to the mini JST connector on the controller;
3. connect the 4-wire cable to the mini JST or screw/removable connector on the user interface.

⚠ Caution: for HMIs with screw or removable terminals, respect the order of the wiring.

🔍 Notice: see “Introduction” for the cable part numbers.

2.8 Description of the terminals

Small model

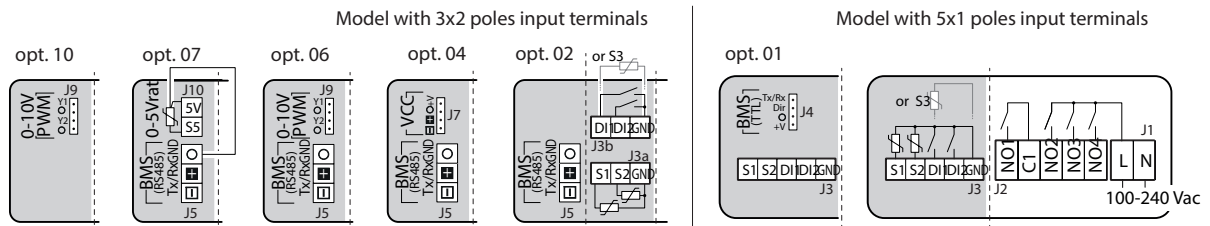

Fig. 2.o

Ref.	Description
J1	L — Power supply N — Power supply
J2	NO1 Digital output (relay) 1 C1 Common for relay 1 NO2 Digital output (relay) 2 NO3 Digital output (relay) 3 NO4 Digital output (relay) 4
J3, J3a, J3b	S1 Analogue input 1 (NTC, PTC or PT1000, NTC_HT and NTC_LT) S2 Analogue input 2 (NTC, PTC or PT1000, NTC_HT and NTC_LT) DI1 Digital input 1/Analogue input 3 (NTC, PTC or PT1000, NTC_HT and NTC_LT) DI2 Digital input 2 GND GND: reference for probes, digital inputs and analogue outputs
J4	Tx/Rx TTL port: Tx/Rx Dir TTL port: Dir +V TTL port: +V O TTL port: GND

Ref.	Description
J5	- BMS serial port (RS485): Rx-/Tx- + BMS serial port (RS485): Rx+/Tx+ O BMS serial port (RS485): GND
J7	- VCC serial port: Rx-/Tx- + VCC serial port: Rx+/Tx+ O VCC serial port: GND
J9	Y1 Analogue output 1 O GND: analogue output reference Y2 Analogue output 2 O GND: analogue output reference
J10	5V Ratiometric probe power supply S5 Analogue input 5 (ratiometric probe)

Tab. 2.q

Large model

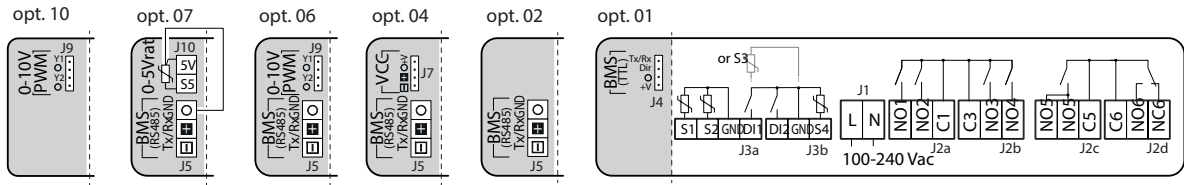

Fig. 2.p

Ref.	Description
J1	L — Power supply N
J2a	NO1 Digital output (relay) 1 C1 Common for relay 1.2 NO2 Digital output (relay) 2
J2b	C3 Common for relay 3.4 NO3 Digital output (relay) 3 NO4 Digital output (relay) 4
J2c	NO5 Digital output (relay) 5 C5 Common for relay 5
J2d	C6 Common for relay 6 NC6 Digital output (relay) 6, normally-closed contact NO6 Digital output (relay) 6, normally-open contact
j3a	S1 Analogue input 1 (NTC, PTC, PT1000, NTC_HT and NTC_LT) S2 Analogue input 2 (NTC, PTC, PT1000, NTC_HT and NTC_LT) GND GND: reference for probes, digital inputs and analogue outputs D11 Digital input 1/Analogue input 3 (NTC, PTC, PT1000, NTC_HT and NTC_LT)
j3b	D12 Digital input 2 GND GND: reference for probes, digital inputs and analogue outputs S4 Analogue input 4 (NTC, PTC, PT1000, NTC_HT and NTC_LT)

Ref.	Description
J4	Tx/Rx TTL port: Tx/Rx Dir TTL port: Dir O TTL port: GND +V TTL port: +V
J5	- BMS serial port (RS485): Rx-/Tx- + BMS serial port (RS485): Rx+/Tx+ O BMS serial port (RS485): GND
J7	- VCC serial port: Rx-/Tx- + VCC serial port: Rx+/Tx+ O VCC serial port: GND
J9	Y1 Analogue output 1 O GND: analogue output reference Y2 Analogue output 2 O GND: analogue output reference
J10	5V Ratiometric probe power supply S5 Analogue input 5 (ratiometric probe)

Tab. 2.r

HMI

Plug-in male-female/ Screw connector

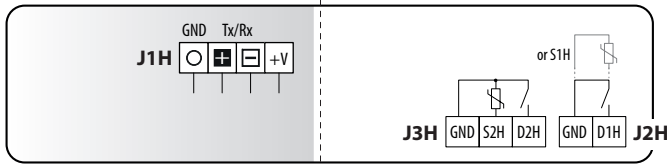

JST ZH connector

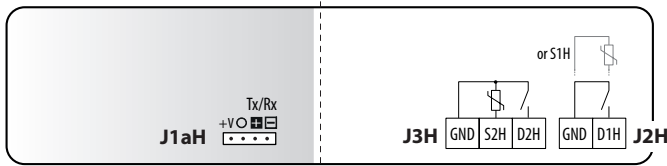
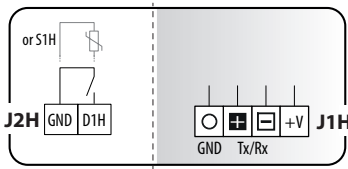

Fig. 2.q

Smart model (IJFHS*)

Plug-in male-female/ Screw connector



JST ZH connector

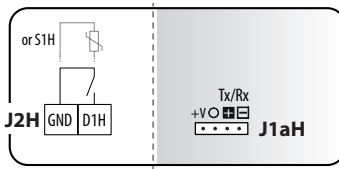

Fig. 2.r

Ref. small	Description
J1H, J1aH	- HMI serial port: Rx-/Tx- + HMI serial port: Rx+/Tx+ O HMI serial port: GND +V HMI serial port: power supply
J2H	D1H HMI digital input 1/HMI analogue input 1 (NTC) GND GND: reference for probes, HMI digital inputs
J3H	GND GND: reference for probes, HMI digital inputs S2H HMI analogue input 2 (NTC) D2H HMI digital input 2

Tab. 2.s

2.9 Probe connections

Notice:

- the probe connections relate to the default parameter configuration;
- probes S1, S2, S3 can be configured as NTC, PTC, PT1000, NTC_HT or NTC_LT; probes S1H, S2H can only be configured as NTC;
- the temperature probes must all be the same type.

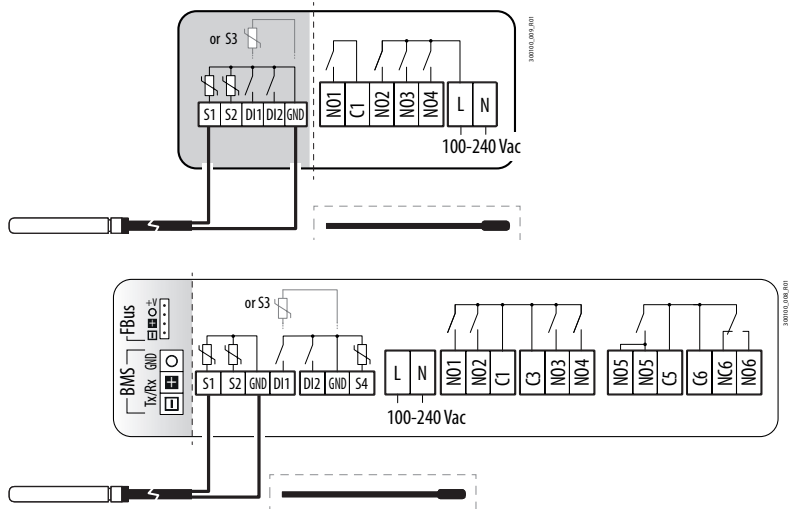

Fig. 2.s

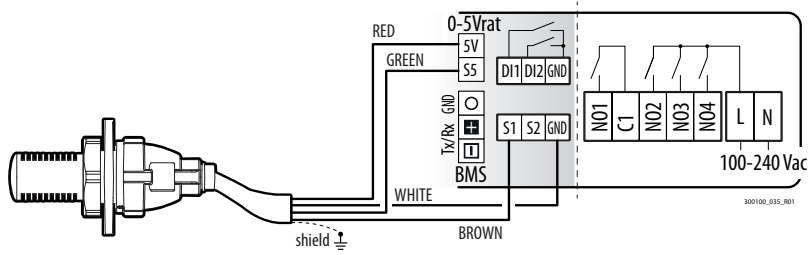

Fig. 2.t

2.10 Connection diagrams

Notice: the “Applica” app and the configuration tool (see the corresponding chapter) can be used to change the configuration of the probes without needing to rewire or change the assignment of the relays to specific functions, thus taking advantage of different capacities when needed.

2.10.1 Small model

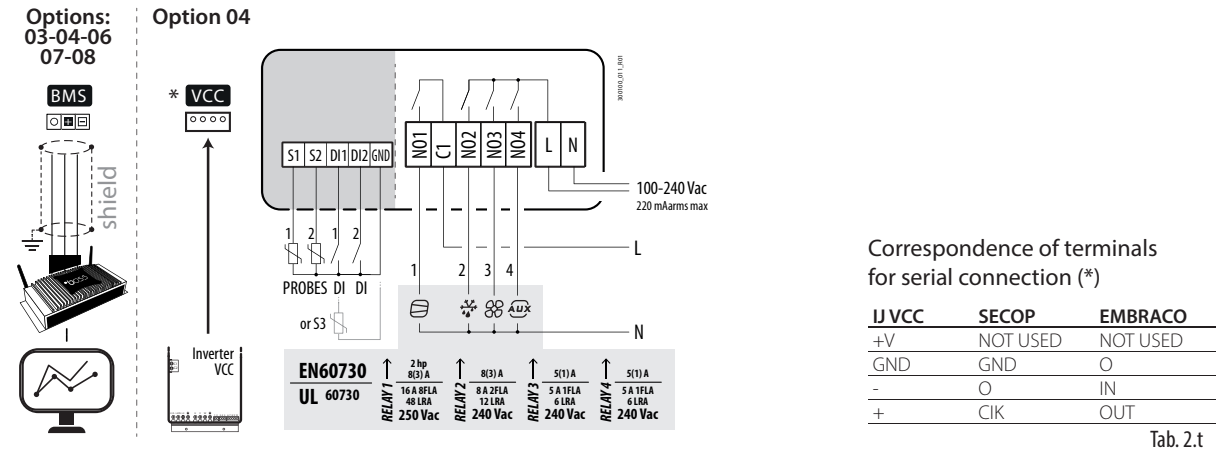

Fig. 2.u

2.10.2 Large model

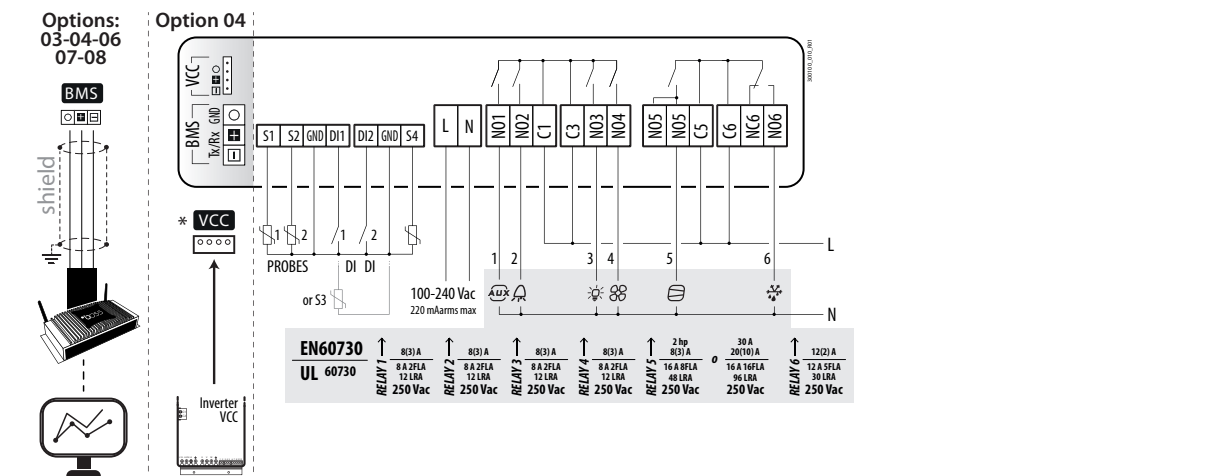

Fig. 2.v

2.11 Positioning inside the panel

The position of the controller in the electrical cabinet must be chosen so as to guarantee correct physical separation from the power components (solenoids, contactors, actuators, inverters, ...) and the connected cables. Proximity to such devices/cables may create random malfunctions that are not immediately evident. The structure of the panel must allow the correct flow of cooling air.

2.12 Electrical installation

Caution: when laying the wiring, “physically” separate the power part from the control part. The proximity of these two sets of wires will, in most cases, cause problems of induced disturbance or, over time, malfunctions or damage to the components. The ideal solution is to house these two circuits in two separate cabinets. Sometimes this is not possible, and therefore the power part and the control part must be installed in two separate areas inside the same panel.

For the control signals, it is recommended to use shielded cables with twisted wires. If the control cables have to cross over the power cables, the intersections must be as near as possible to 90 degrees, always avoiding running the control cables parallel to the power cables.

Pay attention to the following warnings:

- use cable ends suitable for the corresponding terminals. Loosen each screw and insert the cable ends, then tighten the screws. When the operation is completed, slightly tug the cables to check they are sufficiently tight;
- separate as much as possible the probe signal, digital input and serial line cables from the cables carrying inductive loads and power cables to avoid possible electromagnetic disturbance. Never run power cables (including the electrical cables) and probe signal cables in the same conduits. Do not install the probe cables in the immediate vicinity of power devices (contactors, circuit breakers or similar);
- reduce the path of the probe cables as much as possible, and avoid spiral paths that enclose power devices;
- avoid touching or nearly touching the electronic components fitted on the boards to avoid electrostatic discharges (extremely damaging) from the operator to the components;
- do not secure the cables to the terminals by pressing the screwdriver with excessive force, to avoid damaging the controller: maximum tightening torque: 0.22-0.25 N•m.
- for applications subject to considerable vibrations (1.5 mm pk-pk 10/55 Hz), secure the cables connected to the controller around 3 cm from the connectors using cable ties;
- all the extra low voltage connections (analogue and digital inputs, analogue outputs, serial bus connections, power supplies) must have reinforced or double insulation from the mains network.

2.13 Serial port connections

For serial connections (FBus and BMS ports), the cables used must be suitable for the RS485 standard (shielded twisted pair, see the specifications in the following table). The earth connection of the shield must be made using the shortest connection possible on the metal plate at the bottom of the electrical panel.

Main device	Serial port	Lmax (m)	Wire/wire capacitance (pF/m)	Resistance on last device	Max secondary devices on bus	Data rate (bit/s)
IJ%	VCC	500	<90	-	1	600
PC (supervision)	BMS	500	<90	120 Ω	-	19200
PC (supervision)	TTL	<90	-	-	19200	-

Tab. 2.u

⚠ Caution: connect the shield to the earth in the electrical panel. Connect a 120 Ω terminating resistor between the Tx/Rx+ and Tx/Rx- terminals on the last controller on the RS485 line. Do not connect GND to earth.

2.14 Installation

For installation proceed as follows, with reference to the wiring diagrams:

- before performing any operations on the control board, disconnect the main power supply by turning the main switch in the electrical panel OFF;
- avoid touching the control board, as electrostatic discharges may damage the electronic components;
- the index of protection required for the application must be ensured by the manufacturer of the cabinet or by suitable assembly of the controller;
- connect any digital inputs, Lmax = 10 m;
- connect the actuators: the actuators should only be connected after having programmed the controller. Carefully evaluate the maximum ratings of the relay outputs as indicated in "Controller electrical and physical specifications";
- program the controller: see "User interface";
- for safety devices (e.g. circuit breakers), comply with the following requirements:
 - IEC 60364-4-41;
 - standards in force in the country;
 - connection technical requirements of the power company.

⚠ Caution: the following warnings must be observed when connecting the controllers:

- incorrect connection to the power supply may seriously damage the controller;
- use cable ends suitable for the corresponding terminals. Loosen each screw and insert the cable ends, then tighten the screws and lightly tug the cables to check correct tightness;
- separate as much as possible the probe and digital input cables from cables to inductive loads and power cables, so as to avoid possible electromagnetic disturbance. Never run power cables (including the electrical panel cables) and probe signal cables in the same conduits;
- do not install the probe cables in the immediate vicinity of power devices (contactors, circuit breakers, etc.). reduce the path of probe cables as much as possible, and avoid spiral paths that enclose power devices.

3. CONFIGURATION TOOLS

3.1 Spark: configuration and commissioning software

Spark is configuration software for laptops that provides the following functions:

- configure access and password levels;
- change parameter sets and create custom read/write lists to upload to the device;
- add languages and parameter descriptions;
- view the trends of physical quantities in real time, with the possibility to save data in Excel format.

In order to carry out the operations mentioned above, it is necessary to have a specific "workspace" file (file with .spark extension), which can be downloaded from ksa.carel.com.

Notice: the workspace is specific for each firmware version; the correct combination of file-controller firmware version is required for correct communication.

For the electrical connection, use the USB/RS485 converter CVSTDUMOR0 for models equipped with BMS port option.

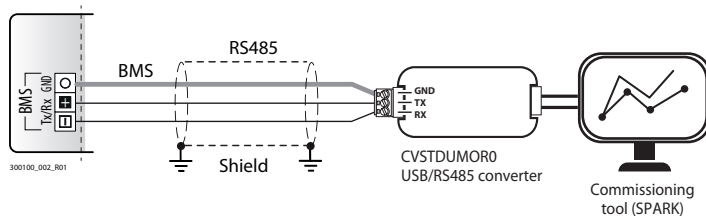

Fig. 3.a

For models without BMS port option, the USB/ID converter BXOPZIOWD000 can be used, connecting to digital input ID2 and completing the specific procedure on Spark.

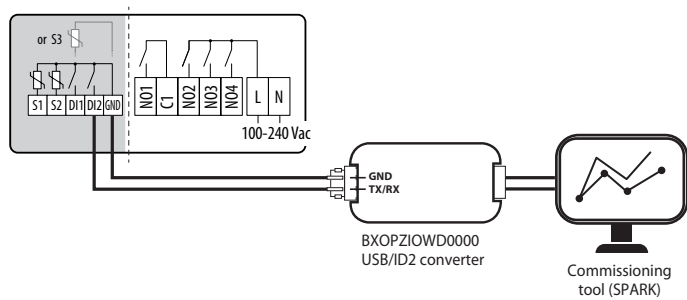

Fig. 3.b

3.2 Sparkly: command-line configuration and commissioning software

Sparkly is the command-line version of the configuration tool, and can be used for configuring and commissioning iJF. Contact Carel for support.

3.3 Applica app and Controlla

The Carel apps can be used to configure the controller from a mobile device (smartphone, tablet), via NFC (Near Field Communication) or BLE (Bluetooth Low Energy). Supported devices: Android 5.1, iOS 10, Bluetooth® 4.0 and higher.

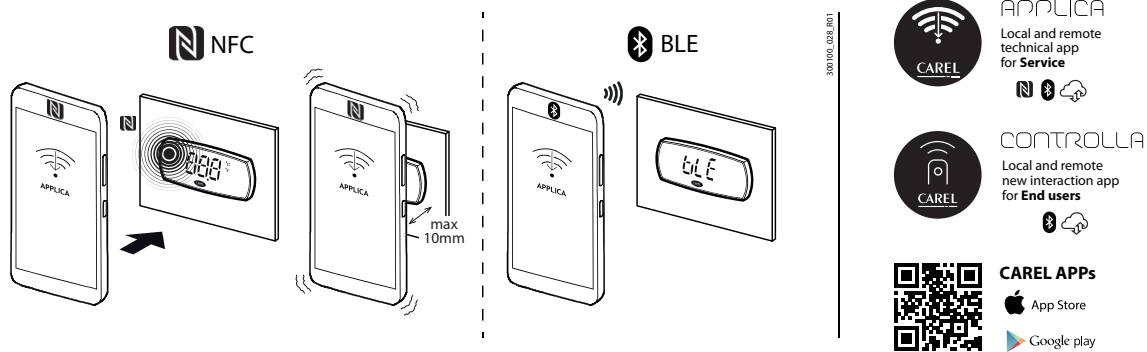

Fig. 3.c

Procedure (modify parameters):

- download the CAREL “Applica” or “Controlla” app from Apple Store or Google Play;
- (on the mobile device) enable NFC and/or Bluetooth communication and mobile data;
- open Applica (or Controlla);
- select NFC or Bluetooth® communication, depending on the model of iJF model;
- move the mobile device near to the user terminal, maximum distance 10 mm (for NFC only), so as to recognise the configuration;
- select the access profile and enter the required password (*);
- set the parameters as needed;
- move the mobile device near to the user terminal again to upload the configuration parameters (for NFC only).

(* pre-assigned by the unit manufacturer to allow maintenance only by authorised service technicians, default “44”. See the parameter table.

Notice:

- make sure NFC or Bluetooth have been enabled. Some smartphones may experience problems if location is not enabled.
- during Bluetooth® connection, the iJF user terminal is disabled and shows the message “bLE”.

3.4 Applica Desktop

Applica Desktop is configuration software for laptops that provides the following functions:

- configure the controller;
- change parameter sets and create custom lists to upload to the device;
- view the trends of physical values in real time, with the possibility to save data in Excel format.

For the electrical connection, see “Spark: configuration and commissioning software”

3.4.1 NFC communication for split and HMI models

All iJF models are equipped with NFC memory, which can be used to set the parameters. Due to its operating characteristics, the NFC memory is always active, even when the device is turned off. However, there are limitations for setting the parameters on the SPLIT and HMI models using NFC, as shown in the table.

Model	Programmability via NFC	
	Controller off	Controller on
Panel	YES	YES
Split	NO	YES
HMI	NO	YES

Tab. 3.a

Notice:

- when the HMI is connected to the SPLIT controller, the NFC memory on the controller is disabled.
- If replacing the HMI, when first starting the iJF split controller the working parameters are written to the HMI NFC memory.

Communication with the NFC memory can be disabled at any time by setting parameter “nFE”. If nFE = 0, writes to NFC memory are ignored by the controller.

4. USER INTERFACE

4.1 Introduction

iJF is available in panel versions with front mounting and built-in display, or in the split version with rear panel mounting, with or without HMI terminal. For rear panel mounting, however, a basic user interface is provided, comprising two status LEDs, while the front panel and remote terminal feature the display and keypad with backlit or non-backlit buttons (depending on the models) for carrying out some of the controller programming operations. The user interface display features three digits with sign for below-zero temperatures and decimal point, a buzzer for signalling alarms and nine icons. The terminal features wireless connectivity and an NFC (Near Field Communication) or Bluetooth interface (depending on the model) for interaction with mobile devices (on which the CAREL "Applica" app has been installed, available on Google Play for the Android operating system and on the Apple Store for iOS devices (Bluetooth only).

 **Notice:** for simplicity, the set of parameters accessible from the user interface is a subset of all the parameters available via the Applica app.

The information available on the user terminal and in the Applica app may vary according to the type of profile, the password entered and the configuration parameters set by the manufacturer. See the parameter table.

 **Notice:** the user and service passwords can be changed directly by accessing the parameter list in the Applica app, and can contain up to 8 alphanumeric and special characters.

Code	Description	Def.	Min	Max	UOM	User	User terminal
PDM	Manufacturer password	44	0	999	-	M	NO
PDS	Service password	22	0	999	-	S	NO
PDU	User password	0	0	999	-	U	NO

Parameter /5 can be set to change the unit of measure of the values shown on the display, while parameter /6 selects whether or not to display the decimal point.

 **Notice:** parameter /5 only affects the controller's display and not Applica and the configuration tool, which need to be set accordingly.

Code	Description	Def.	Min	Max	UOM	User
/5	Unit of measure: 0 = °C; 1 = °F	0	0	1	-	U, S
/6	Display decimal point (main screen only): 0 = visible; 1 = not visible	0	0	1	-	S

Parameter Hb can be set to enable or disable the buzzer (on models where featured).

Code	Description	Def.	Min	Max	UOM	User
Hb	Enable buzzer: 0 = disabled; 1 = enabled	1	0	1	-	U, S

Parameter /nE can be used to enable or disable navigation via the user terminal, while parameter BtE can be used to disable Bluetooth communication.

Due to its operating characteristics, the NFC memory is always active, while parameter nFE can be used to have the controller ignore writes to NFC memory.

Code	Description	Def.	Min	Max	UOM	User
/nE	Navigation on the display 0 = Disabled; 1 = Enabled	0	0	1	-	M
BtE	Bluetooth communication 0 = Disabled; 1 = Enabled	1	0	1	-	M
nFE	Communication with NFC memory 0 = Disabled; 1 = Enabled	1	0	1	-	M

Parameters /Lb and /Sb can be set to change how the terminal behaves in standby; specifically, /Lb enables or disables the lighting on the status LEDs (icons), including ON/OFF, while /Sb enables or disables the lighting on the PRG button. writes to NFC memory are ignored by the controller

Code	Description	Def.	Min	Max	UOM	User
/Lb	Status LEDs on in standby (including ON/OFF): 0 = off; 1 = on.	0	0	1	-	M
/Sb	PRG button always ON in standby: 0 = off; 1 = on.	1	0	1	-	M

4.2 Models with user terminal or remote HMI

User terminal

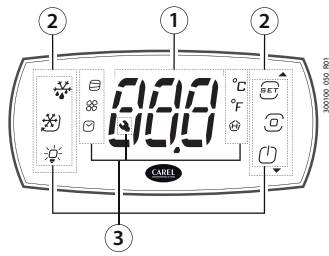

Fig. 4.a

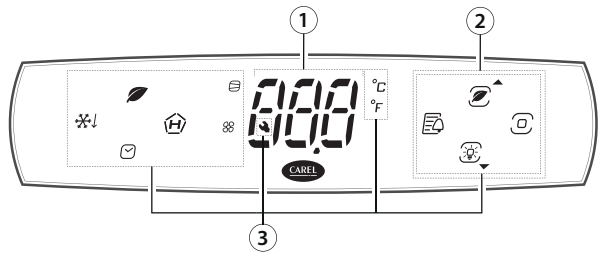

Fig. 4.b

Key:

1	Display
2	Icons/buttons
3	Icons

Notice:

- the user terminal can only be used to set the frequent (User) and (Service) parameters and display the value of the probes connected to iJF. The Service- and Manufacturer-level parameters are set using the Applica app or the configuration software, depending on the access profile. See the parameter table and the paragraph "Parameter categories visible on the user terminal";
- Parameter /t1 is used to choose the variable to be shown on the display during normal operation;
- Parameter /5 is used to change the unit of measure .
- Parameter /d6 is used to choose the value to be shown on the display when defrosting:

Code	Description	Def.	Min	Max	UOM	User	User terminal
/5	Unit of measure: 0 = °C; 1 = °F	0	0	1	-	S	YES
/6	Display decimal point: 0 = Yes; 1 = No	0	0	1	-	S	NO
/t1	Display on user terminal:	9	0	15	-	S	NO
	0 Not configured	6-8	not available				
	1 value of S1	9	control probe				
	2 value of S2	10	virtual probe				
	3 value of S3	11-14	not available				
	4 value of S4	15	actual control				
	5 value of S1H		set point				
d6	Display on terminals during defrosts: 0 = temperature alternating with 'dEF'; 1 = freeze display; 2 = 'dEF'	1	0	2	-	U	NO

Tab. 4.a

Keypad

Icon/button	Description	On	Flashing
	Set point/Up arrow	<ul style="list-style-type: none"> • Increase value • Scroll menu • Direct access to change set point 	-
	Program	Pressed briefly: <ul style="list-style-type: none"> • enter menu branch • save value and return to the parameter Pressed and held (3 s): <ul style="list-style-type: none"> • enter programming mode • return to the previous level code 	-
	On-Off/Down arrow	<ul style="list-style-type: none"> • Unit ON • Decrease value • Scroll menu • Switch unit on/off 	-
	Defrost	Active/stop	Awaiting/start
	Continuous cycle	Active/stop	Awaiting/start
	Lights	Active/stop	Activation
	HACCP	<ul style="list-style-type: none"> • HACCP alarms present • Direct access to HACCP menu 	-
	Alarm log	<ul style="list-style-type: none"> • Logged alarms present • Direct access to the alarm log menu 	-
	Auxiliary output	Active	-
	Compressor	Active	Awaiting
	Evaporator fan	Active	-
	Clock	Scheduler active	-
	°C	Unit of measure °C	-
	°F	Unit of measure °F	-
	Service Maintenance	Active alarms	-

Tab. 4.b

Notice: during navigation, the buttons will be on/flashing only if enabled.

4.2.1 Navigation

The figure shows how to navigate between the screens on the display; specifically, the grey part shows programming mode for setting the parameters. The screens and functions of the buttons available on each screen are described in detail below.

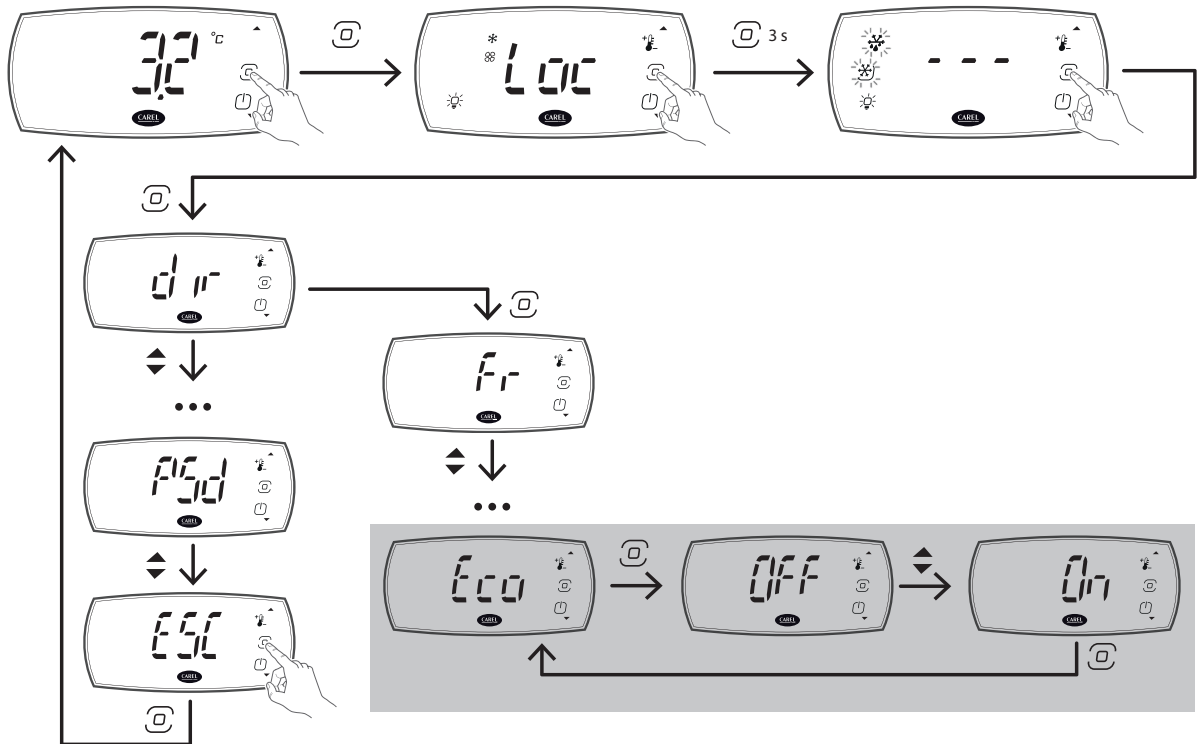

Fig. 4.c

4.2.2 Screens

The possible states of the terminal are shown in the table below.

<p>Status Standby</p>	<p>Status Display active loads</p>	<p>Status Direct activation of loads and functions from the keypad</p>	<p>Status Programming menu</p>
<p>Description The display shows the main value, alternating with any alarms and signals</p>	<p>Description The terminal shows any active loads, the keypad is locked</p>	<p>Description The loads can be activated or deactivated and the direct functions accessed from the keypad</p>	<p>Description Scroll the programming menu using the arrow buttons</p>
<p>Status Parameter programming/display values</p>	<p>Status Bluetooth connection</p>		
<p>Description Set the parameters using the arrow buttons or display read-only values</p>	<p>Description The display is disabled, as the controller is connected to an app via Bluetooth Low Energy</p>		

Standard display

At power on, the user terminal briefly shows the firmware version and then the standard display. The standard display depends on the setting of parameter /t1:

- control temperature (control probe temperature or calculated based on two probes, see “Functions”);
- value of one of the probes connected to the analogue inputs;
- control/virtual probe;
- temperature set point.

Notice: if there is an active alarm, press any button to mute the buzzer.

Display active actuators/functions and direct activation of actuators/functions

When pressing any button, the display shows the message “Loc” and the icons corresponding to the currently-active actuators/functions come on to indicate the status of the unit. On pressing PRG for 3 s, the display shows 3 dashes in sequence and enters actuator/function direct activation mode. In this mode:

- the buttons that are on steady indicate that the corresponding actuator/function is active, and can be deactivated by pressing the button;
- the buttons that are flashing indicate that the actuator/function is not active and can be activated by pressing the button;

When pressing the button, the display shows information on the status of the selected actuator/function (On/Off).

Icon	iJF small	iJF large	On/Off
	•	•	Lights
	•	•	Continuous cycle
	•	•	Defrost
	•	•	Direct access to set point
	•	•	Unit On/Off
	-	•	Direct access to HACCP alarms
	-	•	Direct access to alarm log

Tab. 4.c

Notice: if no button is pressed, after 7 seconds the terminal will automatically return to the standard display.

4.2.3 Programming mode

In actuator/function direct activation mode, pressing PRG enters programming mode, where the unit’s main operating parameters can be set. To access the Service parameters, go to the “PSD” menu item (see the table below) and enter the password (default 22). The user terminal only provides access to the basic configuration parameters, such as direct functions and active alarms without password protection, or, with password protection (Service).

Notice: in the default settings the user password is set to 0 and is not required when entering programming mode; if the password has been set to a value other than 0, this needs to be entered to access programming mode. Access to the Service level is also available by entering the default password 22.

Notice: for optimisations use Applica, which provides access to all of the parameters available for the corresponding profile.

Parameter categories visible on the user terminal

The menu items available and parameters visible on the user terminal are listed below. The menu branches/parameters protected by the Service password (default 22) are shown in bold italics.

dir (*) (Direct functions)	CtL (Control)	Pro (Display probes)	dEF (Defrost)	HcP (HACCP)	CnF (Configuration)	ALM (Alarms)	PSD	ESC
See the following table	St	/5	dl	HAn	Hb	AH/AHA		
	rd	/6	dP1	HF _n	H0	AL/ALA		
	Sth	/t1	dt1	rHP	H10	Ad		
	rdh	ESC	dP2	ESC	H11	Add		
	HU		dt2		ESC	rSA		
	rM		d6			rAL		
	rt (**)		d8			ESC		
	IS (***)		ESC					
	rSC							
	ESC							

Tab. 4.d

(*) The visibility of the direct functions can be set using the corresponding parameters, and depends on whether the functions are available on the controller.

(**) Visible if the corresponding monitoring function is enabled.

(***) Visible if there is at least one configuration loaded on the controller (see “Appendix”)

Direct functions

Acr.	Description	Display alarms	Acr.	Description	Display alarms
Auc	Activate auxiliary output	DOC > 0	rH	Maximum value of control probe	rM = 1
BtE	Enable Bluetooth	if featured	rL	Minimum value of control probe	rM = 1
CnC	Activate continuous cycle	cc > 0	rtL	Reset min/max control probe	rM = 1
dFM	Start defrost		SAh	Display alarm log	
Ec1	Load embedded configurazion 1	if featured	Sc	Condenser probe	/Fo > 0
Ec2	Load embedded configurazion 2	if featured	Sc1	Quick Set point 1	
Eco	Activate ECO mode		Sc2	Quick Set point 2	
Fr	Firmware version		Sc3	Quick Set point 3	
HAC	Direct access to HACCP menu		Sd	Defrost probe	/Fb > 0
HL	Dim Light	/AF > 0	SHu	Humidity probe	/FP > 0
HU	Set humidity level	F2 = 3	Sm	Outlet probe	/Fa > 0
Lht	Activate lights	DOE > 0	SPr	Product probe	/FR > 0
nFE	Enable NFC memory reading		SrG	Control probe	
OnF	Unit On/Off		St	Set control set point	
Pd	Activate pull down		Sth	Set humidity set point	/SP > 0

Tab. 4.e

Procedure

To navigate the menu tree, use the following buttons:

- UP and DOWN to navigate the menu and set the values;
- PRG to enter the menu items and save the changes made;
- Select the menu item or ESC to return to the previous branch.

Example of how to set parameter St (set point):



1. Wait for the standard display to be shown;



2. Press PRG to enter display active actuators/functions mode



3. Press PRG 3 s to access actuator/function direct activation mode



4. Press PRG to enter programming mode; the UP and DOWN buttons will flash and the first category of parameters dir (=direct functions) will be displayed;



5. Press DOWN until reaching the parameter category Ctl (=control)



6. Press PRG to display the first menu item: St (=set point). Press PRG to display the parameter value



7. Press UP/DOWN to modify the value



8. Press PRG to save the setting and return to the menu

Caution: if the PRG button is not pressed, the new setting will not be saved.



9. Press UP/DOWN to select ESC and press PRG to return to the parameter categories;



10. Press DOWN to move to the next category and follow steps 6 to 9 to set the other parameters;



11. Once the settings have been made, to exit the categories select ESC and press PRG.

Notice: if no button is pressed, after 20 seconds the terminal will automatically return to the standard display.

Mobile device and PC

The controller can be configured via NFC (Near Field Communication) or Bluetooth from a mobile device (smartphone, tablet) using Applica, or via serial connection (laptop) using the configuration tools. The controller can be programmed according to the profile used for access to Applica or Spark, with different parameter visibility depending on the rights associated with each profile (User, Service, Manufacturer). See "Configuration tools".

Notice: when changing the parameter settings, it is recommended to power the controller off and on again to realign any timings in progress. Caution: wait at least 5 seconds are changing the parameter settings before powering the controller off, to allow the data to be correctly saved to the memory.

4.3 SPLIT models without user terminal

For Split mounting versions, a basic user interface is provided, comprising two status LEDs.

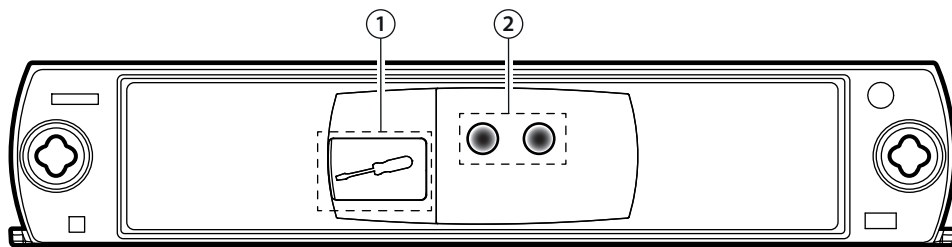

Fig. 4.d

Key:
 1 HMI connector
 2 Status LEDs

The meaning of the status LEDs is described in the table below.

Red LED	White LED	No. flashes	Description	Red LED	White LED	No. flashes	Description
○	●	-	Unit OFF	☀	○	4	Defrost alarms: Ed1, Ed2
○	☀	1	Unit ON	☀	○	5	Pumpdown alarms: Pd, LP, AtS
○	☀	2	<ul style="list-style-type: none"> Defrost active (dEF) Continuous cycle active ECO mode 	☀	○	6	Parameter configuration alarms: EE, EF
☀	○	1	Probe alarms: rE, E1, E2, E3, E4, E5	☀	○	7	Refrigerant leak alarm: rSF
☀	○	2	Temperature alarms: LO, HI, Afr, cht, CHt, dor	☀	○	8	Clock alarm: Etc
☀	○	3	Alarms from external contact: IA, dA	☀	○	9	HACCP alarms: HA, HF

Tab. 4.f

5. COMMISSIONING

Once the electrical connections have been completed (see "Installation") and the power supply has been connected, the operations required for commissioning the controller depend on the type of interface used, however essentially involve setting the so-called initial configuration parameters. The configuration procedure can be run on the user terminal, a mobile device (with the Applica app), or configuration tool. The parameters used for commissioning are shown in the Parameter table.

⚠ Caution:

- the parameters that can be set on the user terminal and in the Applica app may vary according to the rights assigned to the access profile, defined by the manufacturer. Therefore, not all of the following parameters may be visible or modifiable.
- Some operations can only be performed using Applica or the configuration tools, for example, configuring the temperature probe type or setting the date/time and time bands

Commissioning parameters

Par.	Menu	Desc.	Def.	Min	Max	UOM	User
St	Ctl	Temperature control set point	50	r1	r2	°C/°F	U, S
/5	Pro	Unit of measure: 0 = °C; 1 = °F	0	0	1	-	U, S
/6	Pro	Display decimal point (main screen only): 0 = visible; 1 = not visible	0	0	1	-	S
/t1	Pro	Value shown on the LED display: 0: Not config. (decimal point); 1: Probe 1; 2: Probe 2; ..., 7, 8: reserved; 9: Control probe, 10: Virtual probe (Sv); 11 to 14: reserved; 15: Set point (St); 16: Current set point	10	0	16	-	S
d6	dEF	Display during defrosts: 0 = temperature alternating with dEF; 1 = freeze display; 2 = dEF	1	0	2	-	S
dl	dEF	Maximum interval between defrosts	8	0	240	h	S
dP1	dEF	Maximum defrost duration	45	1	240	min	S
AH	ALM	Relative high temperature alarm threshold	0	0	555/999	Δ °C/°F	S
AL	ALM	Relative low temperature alarm threshold	0	0	200/360	Δ °C/°F	S
Hb	CnF	Enable buzzer: 0 = disabled; 1 = enabled	1	0	1	-	U, S
/P1	-	Configure probe: S1, S2, S4 0 : PT1000; 1 : PTC; 2 : NTC; 3 : NTC-LT; 4 : NTC-HT	2	0	4	-	M
/P2	-	Configure probe: S3/ ID1 - 0 : S3; 1 : ID1	5	0	5	-	M

Tab. 5.a

(*): U = User; S = Service; M = Manufacturer (OEM).

5.1 Description of the initial configuration parameters

St: temperature control set point

Parameter St is used to set the temperature control set point.

Par.	Menu	Desc.	Def.	Min	Max	UOM	User
St	Ctl	Temperature control set point	50/122	r1	r2	°C/°F	U, S

rd: temperature control differential

Parameter rd is used to set the temperature control differential (see "Control").

Par.	Menu	Desc.	Def.	Min	Max	UOM	User
rd	Ctl	Temperature control differential	2.0/3.6	0.1/0.2	99.9/179.2	Δ °C/°F	S

/5, /6, /t1: display on user terminal

Parameters /5, /6 and /t1 are used to set the display shown on the user terminal. Parameter /5 sets the unit of measure °C or °F, parameter /6 sets whether or not the decimal digit is displayed and parameter /t1 sets the value displayed, either the control probe or virtual probe reading, or one of the set points. By default, the virtual control probe value is displayed, expressed in °C with one decimal.

Par.	Menu	Desc.	Def.	Min	Max	UOM	User
/5	Pro	Unit of measure: 0 = °C; 1 = °F	0	0	1	-	U, S
/6	Pro	Display decimal point (main screen only): 0 = visible; 1 = not visible	0	0	1	-	S
/t1	Pro	Display on user terminal: 0 = Not configured; 1 to 4 = value of S1 to S4; 5 = value of S1H; 6 to 8 = not available; 9 = control probe; 10 = virtual probe; 11 to 14 = not available; 15 = actual control set point.	9	0	15	-	S

d6: display on user terminal during defrosts

Parameter d6 is used to set the display shown on the user terminal when defrosting, chosen between the value selected by parameter /t1 alternating with the message 'dEF', the last value shown before defrosting, or 'dEF' alone on steady. By default, the virtual control probe value is shown, alternating with the message dEF.

Par.	Menu	Desc.	Def.	Min	Max	UOM	User
d6	dEF	Display during defrosts: 0 = temperature alternating with dEF; 1 = freeze display; 2 = dEF	1	0	2	-	S

dl, dP1: defrost parameters

Parameter dl is used to set the maximum possible interval between defrosts, while parameter dP1 is used to set the maximum defrost duration. See "Functions" for more details.

Par.	Menu	Desc.	Def.	Min	Max	UOM	User
dl	dEF	Maximum interval between defrosts	8	0	240	h	S
dP1	dEF	Maximum defrost duration	45	1	240	min	S

Hb: enable buzzer

Parameter Hb is used to enable or disable the buzzer built into the controller; the buzzer is enabled by default.

Par.	Menu	Desc.	Def.	Min	Max	UOM	User
Hb	CnF	Enable buzzer: 0 = disabled; 1 = enabled	1	0	1	-	U, S

/P1, /P2: Probe types

Probes S1, S2, S3 can be configured as NTC, PTC, PT1000, NTC_HT or NTC_LT. Parameter /P1 is used to set the type of temperature probe.

Parameter /P2 is used to choose whether the multifunction input S3/ID1 is configured as a temperature probe (and in this case it will be same type set by parameter /P1) or as a digital input. Parameters /P1 and /P2 can only be set using Applica or configuration tool.



Notice: the temperature probes must all be the same type.

Par.	Menu	Desc.	Def.	Min	Max	UOM	User
/P1	-	Configuration of probes S1, S2, S3, S4, B5 0 = PT1000; 1 = PTC; 2 = NTC; 3 = NTC-LT; 4 = NTC-HT.	2	0	4	-	M
/P2	-	Configuration of multifunction input S3/ ID1: 0, 1, 2, 3, 4 = S3; 5 = ID1.	5	0	5	-	M

AH/AL: relative high and low temperature alarm thresholds

Parameters AH and AL are used to set the thresholds relative to the set point for the high and low temperature alarms. For details on the high and low temperature alarms, see "Alarms".

Par.	Menu	Desc.	Def.	Min	Max	UOM	User
AH	ALM	Relative high temperature alarm threshold	0	0	555/999	Δ °C/°F	S
AL	ALM	Relative low temperature alarm threshold	0	0	200/360	Δ °C/°F	S

5.2 Set date/time and time bands

The smartphone's date and time can be used to set the controller's date/time, via the drop-down menu on the side in Applica, selecting "settings-->device-->set date/time".

Procedure for setting the time bands:

1. open Applica on the smartphone;
2. access the controller via NFC or Bluetooth, entering your profile credentials;
3. open the "Scheduler" section;
4. define the time bands for the different days of the week;
5. apply the set schedule to the controller (upload button at the top-right for connection via NFC).



Notice: 8 daily time bands can be configured by setting parameters tS1, tE1 to tS8, tE8.



Notice: always check the correct date and time setting for using the logs and other functions that refer to the RTC.

The correct setting of date and time is necessary for the operation of some features of the iJF control:

- activation of the light or auxiliary output (par. H8) according to the set time bands;
- management of defrosts by time bands;
- monitoring and recording of a temperature;
- counting of operating hours and activation of the maintenance alarm when a settable threshold is exceeded;
- recording of periodic and event logs.



Notice: using parameter dl it is possible to perform cyclic defrosts every "dl" hours, even in the absence of the RTC clock..



Caution: A change in the time set in the iJF control exceeding 140 minutes causes the loss of the stored logs..

5.3 Checks after commissioning

Once having completed the installation, configuration and programming operations, after commissioning the controller check that:

- the programming logic is suitable to control the unit and the system in question;
- the time has been set on the controller;
- the time bands have been set correctly;
- the standard display has been set on the user terminal;
- the appropriate unit of measure has been set for the temperature probes (°C or °F);



Caution: at the end of the commissioning procedure, the alarm log can be reset via the Applica app. See "Alarms".

6. FUNCTIONS

The following paragraphs describe how to implement a detailed parameter configuration. The parameters described below can be configured via the Spark configuration software or the Applica app.

⚠ Caution: the information available in Applica may vary according to the password set and the configuration defined by the unit manufacturer, and consequently not all of the parameters shown may be visible or modifiable. For details on the parameters and the related access levels, see the "Parameter table".

6.1 ON/OFF

The unit can be switched on or off in different ways: user interface (button or parameter), supervisor and digital input. Parameter On is used to switch the controller ON/OFF. If there is a digital input configured as remote ON/OFF, this has higher priority than the supervisor command or the On parameter.

P/N	Desc.	Def.	Min	Max	UOM	User	User terminal
DIF	Assign remote ON/OFF digital input - see DIA	0	0	4	-	S	NO
On	ON/OFF command 0= OFF; 1 = ON.	1	0	1	-	U	YES

In this operating mode, the display shows the standard display set by parameter /t1, alternating with the message "OFF".

Functions enabled/disabled in OFF status

Function	Enabled	Disabled
Compressor control (off and pump down valve closed)		●
Dead band control		●
Auxiliary compressor control with and without rotation		●
Defrost		●
Evaporator fan control		●
Humidity control		●
Continuous cycle		●
Condensing fan control (if enabled)		●
Low temperature alarm LO		●
High temperature alarm HI		●
Immediate alarm from external contact IA		●
Delayed alarm from external contact dA		●
Defrost ended due to timeout alarm Ed1, Ed2		●
Pump down ended after maximum time alarm Pd		●
Low pressure alarm from external contact LP		●
Autostart in pump down alarm AtS		●
High condenser temperature warning and alarm cht, CHt	●	
Open door alarm dor		●
Frost protection alarm AFR		●
Type HA and HF HACCP alarm	●	
Buzzer (off) and alarm relay (non-alarm status)		●
HACCP control		●
Defrost according to scheduled time bands		●
Timed defrost (timer "dl" updated)		●
Defrost from digital input (if enabled)		●
Defrost from keypad and supervisor		●
High and low power supply voltage alarm EHI and ELO		●
Generic alarm with high threshold GHI and GLO		●
Refrigerant leak alarm rSF	●	
Maintenance request SrC		●
Operating error UFC and VCC communication error COM		●
Parameter setting and display	●	
Auxiliary relay on/off	●	
Autostart compressor in pump down (if enabled)	●	
Door switch limited to light management	●	
Control probe error alarm rE	●	
Probe error alarm E1, E2, E3, E4	●	
Clock not updated (if featured) alarm Etc	●	
Configuration not terminated correctly alarm SF	●	
Configuration write error CE	●	
Light or aux on/off based on scheduled time bands		●
Set point changed based on scheduled time bands	●	

Tab. 6.a

Notice: in Off status, the defrost interval dl is always updated, in order to maintain the cyclical nature of this interval. If a defrost interval expires when the unit is off, the event is recorded and, when the unit is switched on, a defrost request is generated.

The transition from On to Off occurs as follows:

- the compressor protection times are observed;
- pump down is performed (if enabled);
- defrosting is forcibly terminated and will not resume when switching On;
- the continuous cycle is forcibly terminated and will not be resumed when switching On.

The transition from Off to On occurs as follows:

- the compressor protection times are observed;
- defrosting is not performed at power-on (if enabled), this in fact refers to power-on;
- the compressor and fan delay at power-on c0 is not set, and refers to power-on.

6.2 Inputs and outputs

On the panel models, the iJF controller has a maximum of 3 analogue inputs, 2 digital inputs and 1 multifunction input. In addition, on some models, an additional analogue input is available for connecting a humidity probe. iJF has a maximum of 6 digital outputs, and on some models a maximum of 2 analogue outputs. The HMI models have a maximum of 1 analogue input, 1 digital input and 1 multifunction input, in addition to those available on the connected panel version. See the description of the terminals in "Description of the terminals".

NTC, PT1000, PTC, NTC HT or NTC LT temperature probes can be connected to the analogue inputs; all probes must be the same type, except for any connected to the HMI terminal, which can only be NTC. The analogue outputs are PWM or 0-10 V and are independently configurable. See the parameter table.

Analogue inputs and outputs

Model	Code	Probes						Outputs (Y1, Y2)		
		NTC (-50T90°C)	Pt1000 (-60T120°C)	Passive		NTC HT (-40T150°C)	NTC LT (-80T105°C)	Active 0 to 5 V ratio- metric	PWM	0 to 10 Vdc
				PTC (-50T150°C)	NTC HT (-40T150°C)					
SMALL, panel or split	IJ**SA*****	YES	YES	YES	YES	YES	YES	NO	NO	
	IJ**SA**06*****	YES	YES	YES	YES	YES	YES	NO	YES	
	IJ**SA**07*****	YES	YES	YES	YES	YES	YES	YES	NO	
SMALL, HMI	IJ**HSA*****	YES	NO	NO	NO	NO	NO	NO	NO	
LARGE panel or split	IJ**LA*****	YES	YES	YES	YES	YES	YES	NO	NO	
	IJ**LA**06*****	YES	YES	YES	YES	YES	YES	NO	YES	
	IJ**LA**07*****	YES	YES	YES	YES	YES	YES	YES	NO	
LARGE, HMI	IJ**HLA*****	YES	NO	NO	NO	NO	NO	NO	NO	

Tab. 6.b

6.2.1 Probes (analogue inputs)

Analogue input Parameter for type of probe	Small			Large					HMI SMALL	HMI LARGE	
	S1 /P1	S2 /P1	S3 /P2	S1 /P1	S2 /P1	S3 /P2	S4 /P1	S1H /P7	S1H /P7	S2H -	
0 : PT1000	●	●	●	●	●	●	●				
1 : PTC	●	●	●	●	●	●	●				
2 : NTC	●	●	●	●	●	●	●	●	●	●	
3 : NTC-LT	●	●	●	●	●	●	●				
4 : NTC-HT	●	●	●	●	●	●	●				
5 : Digital input			●			●		●	●		

Tab. 6.c

The 0-5 V ratiometric humidity probe, available on some models, does not need to be configured.

Caution: for the maximum current that can be supplied to the ratiometric probes, see the Technical specifications table.

To assign the function to each physical probe, configure parameters /FA, /Fb, ... /FR. See the parameter table.

Probe	Par.	Probe	Par.	Probe	Par.
Outlet (Sm)	/FA	Auxiliary temperature 1 (Saux 1)	/FG	Condensing temperature	/Fo
Defrost (Sd)	/Fb	Auxiliary temperature 2 (Saux 2)	/FH	Ambient humidity	/Fp
Intake (Sr)	/Fc	Ambient temperature	/FI	Frost protection temperature	/Fq
Defrost probe 2 (Sd2)	/FF	Glass temperature	/FM	Product temperature	/FR

Tab. 6.d

Example of probe configuration.

To associate a function with a physical probe, set the value of the corresponding parameter /Fx to the value corresponding to the probe, as shown in the following table. For example, to assign the outlet temperature to probe S1, set parameter /FA to 1.

Code	Desc.	Def.	Min	Max	UOM	User	User terminal
/FA	Outlet probe configuration: 0: Disabled - 1: S1 - 2: S2 - 3: S3 - 4: S4 - 5: S5 - 6: S1H - 7: S2H	1	0	7	-	S	No

The default configuration for assigning the control probes is as follows:

- S1 = Outlet probe (Sm);
with the default settings, this probe corresponds to the virtual control probe Sv.

The default configuration also sets these three probes as standard CAREL NTC. However, other types of probes can be connected by setting parameter /P1.

Notice:

- the configuration /FA = 0 and /Fc = 0 will cause the 'rE' alarm (control probe alarm), as it means that no control probe is associated.
- For a description of the probe functions, see the following paragraphs.

Calibration (parameters /cA to /cR)

iJF allows the possibility to calibrate values read by the probes associated with the various functions set by parameters /FA to /FR. In particular, parameters /cA to /cY are used to increase or decrease the values read by the probes connected to the analogue inputs, consistently with the unit of measure.

Caution, HACCP: this modification may not be allowed by HACCP procedures as it alters the measured value. Verify that you have authorisation and record the changes where required.

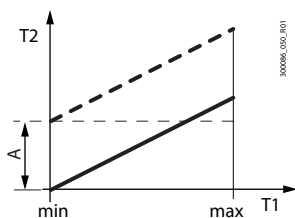

Fig. 6.a

Description

T1	Temperature read by the probe
T2	Calibrated temperature
A	Calibration offset
min, max	Field of measurement

/2: Analogue probe measurement stability and refresh display

Code	Desc.	Def.	Min	Max	UOM	User	User terminal
/2	Analogue probe measurement stability: 0 = probe reading not delayed; ... 15 = maximum probe reading delay	5	0	9	-	M	No
/3	Display probe value: 0 = disabled; 1 = fast update; ... 15 = slow update.	0	1	15	-	M	No

Parameter /2 defines the coefficient used to stabilise the temperature measurement. Low values assigned to this parameter allow a prompt response of the sensor to temperature variations; the reading however become more sensitive to disturbance. High values slow down the response, but guarantee greater immunity to disturbance, that is, a more stable, precise and filtered reading.

Parameter /3 is used to refresh the probe readings displayed; low values of /3 mean the display is refreshed quickly, high values mean it is refreshed slowly.

Note: parameter /3 only affects the display of the probe readings and not the value used for control.

6.3 Digital inputs

iJF manages up to 2 physical digital inputs and 1 multifunction input on the PANEL and SPLIT models, and up to 1 additional digital input and 1 multifunction input on the HMI models. See "Installation".

To associate an input to each available function, set parameters DIA, D1b, ... DIr to the value relating to the physical or virtual digital input. See the parameter table.

Digital input functions

Digital input assignment for:	Par.	Contact (*)	
		Open	Closed
immediate external alarm	DIA	Alarm active	Alarm not active
delayed external alarm	D1b	Alarm active	Alarm not active
enable defrost	D1c	Defrost not enabled	Defrost enabled
start defrost	D1d	No effect	Start defrost
door switch with stopping control	D1E	Door open	Door closed
remote ON/OFF	D1F	OFF	ON
curtain switch/light	D1G	Day status	Night status (ECO mode)
start/stop continuous cycle	D1H	Stop continuous cycle	Start continuous cycle
change set of parameters	D1o	Set 1	Set 2
door switch without stopping control	D1P	Door open	Door closed
generic alarm function	D1S	Alarm active	Alarm not active
low pressure switch	D1t	Alarm active	Alarm not active
auxiliary input	D1U	Auxiliary input deactivated	Auxiliary input activated

Tab. 6.e

(*) Default configuration with parameters r1A, r1b, ..., r1U = 0; by setting the corresponding parameters r1A, r1b, ..., r1U = 1, the contact logic is reversed and therefore the meanings of open/closed are also reversed.

Example of digital input configuration.

To associate a function with a digital input, set the value of the corresponding parameter DIx to the value corresponding to the input, as shown in the following table. For example, to assign the immediate external alarm to input ID1, set parameter DIA to 1.

Code	Desc.	Def.	Min	Max	UOM	User	User terminal
DIA	Immediate external alarm configuration: 0: Disabled - 1: ID1 - 2: ID2 - 3: D1H - 4: D2H	1	0	4	-	S	No

The default configuration does not include an assigned input.

If the opposite logic to the default setting is required, or to correct a wiring error, the logic of the functions associated with the digital inputs using parameters r1A, r1b, ... r1U can be reversed.

Code	Desc.	Def.	Min	Max	UOM
r1A, r1b, ..., r1U	Reverse digital input logic	0	-	0	1

Immediate external alarm (par. DIA)

Activation of the alarm causes:

- message 'IA' shown on the display and the "Service" icon flashing;
- activation of the buzzer (see par. Hb);
- activation of the alarm relay (see par. DOB);
- deactivation of the compressor output (see par. DOA).



Notice: activation of the external alarm shuts down the evaporator fan only if this follows the status of the compressor output, as set for parameter /F2. The compressor is shut down immediately due to an external alarm, and consequently the compressor ON time is ignored (parameter c3).

Code	Desc.	Def.	Min	Max	UOM	User	User terminal
DIA	Assign digital input for immediate external alarm. 0: Disabled - 1: ID1 - 2: ID2 - 3: D1H - 4: D2H	0	0	4	-	S	No

Delayed external alarm (par. D1b)

The behaviour of this alarm is the same as for the immediate external alarm, with a delay in activation set by parameter A7. If set to 0, the alarm is signal-only.

Code	Desc.	Def.	Min	Max	UOM	User	User terminal
D1b	Assign delayed external alarm digital input - see DIA	0	0	4	-	S	No

Enable defrost (par. DIc)

Used to disable any defrost requests. When the contact is open, all defrost calls are ignored. Par. d5 can be used to delay activation.



Notice:

- if the contact is open while a defrost is in progress, this is immediately stopped, the defrost icon flashes on the display indicating the defrost request is active (this starts again when the contact closes);
- this function may be useful to prevent defrosts on units exposed to the public during store opening hours.

Code	Desc.	Def.	Min	Max	UOM	User	User terminal
DIc	Assign enable defrost digital input - see DIA	0	0	4	-	S	No
d5	Defrost delay at power on or after command from digital input	0	0	240	min	M	No

Start defrost (par. DId)

Closing the digital contact starts a defrost, if enabled.



Notice: if the defrost is disabled by another digital input configured as “enable defrost”, the defrost calls are ignored.

Code	Desc.	Def.	Min	Max	UOM	User	User terminal
DId	Assign start defrost digital input - see DIA	0	0	4	-	S	No
d5	Defrost delay at power on or after command from digital input	0	0	240	min	M	No

Door switch with compressor stop (par. DIE)

Door open:

- stop compressor and evaporator fan; alternatively, the compressor can stay on by setting parameter DIP (see the description below);
- light on (see par. DOE);
- ALARM flashing;
- disable temperature alarms.

Door closed:

- resume control;
- light off (see par. DOE) with delay set by par. H14;
- ALARM stops flashing;
- enable temperature alarms with delay Ad after bypass time defined by par. Add.

Code	Desc.	Def.	Min	Max	UOM	User	User terminal
DIE	Assign digital input for door switch with solenoid/compressor and evaporator fans OFF - see DIA	0	0	4	-	S	No
DOE	Assign light digital output - see DOA	4 (small)/ 3 (large)	0	6	-	S	No
H14	Time light stays on after closing the door	0	0	240	min	U	No
Add	High temp. alarm bypass time for door open	30	1	240	min	U	No



Caution: check compatibility of disabling/delaying the alarm with the site’s HACCP procedures.



Notice:

- when control resumes, the compressor times are observed (see the paragraph “Compressor”);
- if the door remains open for longer than the value of par. Add, control resumes in any case. The light remains on, the measurement shown on the display flashes, the buzzer and the alarm relay (if enabled) are activated, and the temperature alarms are enabled with delay Ad.

Door switch without compressor stop (par. DIP)

Operating mode that allows the door to be opened without stopping the compressor.

In this case, when opening the door, the evaporator fan will stop. This operating mode can be configured by setting parameter DIP with one of the digital inputs. Opening the door introduces a temperature alarm delay as described for the door switch function (par. DIE).

Code	Desc.	Def.	Min	Max	UOM	User	User terminal
DIP	Assign door switch without control stop digital input - see DIA	0	0	4	-	M	No

Remote ON/OFF (par. DIF)

When the controller is OFF:

- the user terminal shows the value measured by the set probe (parameter /t1) alternating with the message OFF;
- the auxiliary relays set as AUX and light remain active, while the other auxiliary outputs are deactivated;
- the buzzer and alarm relay are deactivated;
- the following are not performed: control, defrosts, continuous cycle, temperature alarm signals;
- in the transition from ON to OFF the compressor protection times are observed.

When the controller is ON again, the compressor times are observed and all of the functions are reactivated, except for the defrost on start-up and compressor and evaporator fan delay at power on (par. c0).



Notice:

- the OFF command from digital input has priority over those from the keypad or supervisor;
- if the controller remains OFF for a longer time than the value set for parameter dl, a defrost is performed when the controller is switched on again.

Code	Desc.	Def.	Min	Max	UOM	User	User terminal
DIF	Assign remote ON/OFF digital input - see DIA	0	0	4	-	S	No
dl	Maximum interval between consecutive defrosts	8	0	240	hours	S	Yes
c0	Delay to enable solenoid/compressor and evaporator fans at power on	0	0	240	min	M	No

Curtain switch (par. DIG)

Digital input used to manage a curtain and switch from day to night (ECO).

During night status (ECO mode):

- the night-time set point Stn is used for control, calculated based on the set point St plus the offset defined by parameter r4 ($Stn = St + r4$) and r4d is used as the control differential. The control probe can also be modified according to the setting of parameter r6a (0 = virtual probe, 1 = probe), see the paragraph "Control";
- the AUX or light output is deactivated according to the setting of parameter H8.

During day status:

- normal operation resumes: set point = St, virtual probe used as control probe;
- AUX or light output activated according to the setting of parameter H8.

Code	Desc.	Def.	Min	Max	UOM	User	User terminal
DIG	Assign curtain switch digital input - see DIA	0	0	4	-	S	No
H8	Output switched with time bands 0 = Light - 1 = AUX	0	0	1	-	S	No
r4	Automatic night set point variation	0	-50/-90	50/90	°C/°F	S	No
r4d	Night control differential	4/7.2	0.1/0.2	99.9/ 179.2	°C/°F	S	No
r6a	Night control probe 0/1 = virtual probe Sv/intake probe Sr	0	0	1	-	S	No

Start/stop continuous cycle (par. DIH)

When the contact is closed, the continuous cycle is activated, based on parameters cc and ccE (see "Functions").

When the contact opens again, the continuous cycle is deactivated.

Code	Desc.	Def.	Min	Max	UOM	User	User terminal
DIH	Assign start/stop continuous cycle digital input - see DIA	0	0	4	-	S	No

Change working set (par. Dlo)

In this case, it is possible to choose between the configuration set for parameter rS1 (digital input open) and the configuration set for parameter rS2 (digital input closed). The changeover between sets occurs during the transition in status.



Caution: when changing sets, the default parameters for the chosen configuration are loaded, and any settings made by the user to the current set of parameters may be overwritten.



Notice: use the Spark configuration software to set the two default configurations. (see "Installation").

Code	Desc.	Def.	Min	Max	UOM	User	User terminal
Dlo	Assign working parameter set change digital input - see DIA	0	0	4	-	S	No
rS1	Configuration assigned to open digital input	1	0	max no. conf.	-	M	No
rS2	Configuration assigned to closed digital input	2	0	max no. conf.	-	M	No

Generic alarm from digital input (par. DIS)

Activation of the alarm depends on parameter GFA_E. Activation of the alarm causes:

- message GHI shown on the display and ALARM flashing;
- activation of the buzzer (see par. Hb);
- activation of the alarm relay (see par. DOB);

Code	Desc.	Def.	Min	Max	UOM	User	User terminal
DIS	Assign digital input for generic alarm from digital input - see DIA	0	0	4	-	S	No
GFA_E	Generic alarm function, enable 0 = always; 1 = unit ON; 2 = unit OFF; 3 = defrost; 4 = not used; 5 = continuous cycle; 6 = duty setting; 7 = standby; 8 = control; 9 = door open; 10 = active alarm.	0	0	10	-	M	No

Low pressure switch (par. DIt)

If a low pressure switch is connected, the LP alarm is activated on opening. If pump down by pressure is enabled, the pressure switch is used to switch off the compressor and the autostart procedure.

Code	Desc.	Def.	Min	Max	UOM	User	User terminal
DIt	Assign low pressure switch digital input - see DIA	0	0	4	-	M	No

Digital input for activating the output configured as AUX (par. DIU)

Digital input that can be used to activate/deactivate the output configured as AUX (parameter DOC).

Code	Desc.	Def.	Min	Max	UOM	User	User terminal
DIU	Assign AUX output activation digital input - see DIA	0	0	4	-	M	No
DOC	Assign AUX auxiliary digital output - see DOA	0 (small)/ 1 (large)	0	6	-	M	No

6.4 Analogue outputs

On some models iJF has up to two 0-10 V or PWM analogue outputs (Y1, Y2), which can be configured separately by setting the corresponding parameter. The analogue outputs set as PWM can be used as a control signal to manage VCC compressors (up to a maximum of 3 in parallel for each output). The 0-10 V outputs can be used as a control signal for fans, anti-sweat heaters, LED dimmers or generic loads.

Par.	Description	Def	Min	Max	UOM	User	User terminal
/AA	Assign analogue output for modulating evaporator fans: 0 = not configured; 1 = analogue output 1 (Y1); 2 = analogue output 2 (Y2)	0	0	2	-	S	NO
/Ac	Assign analogue output for modulating anti-sweat heaters - see /AA	0	0	2	-	S	NO
/Ad	Assign analogue output for generic function - see /AA	0	0	2	-	S	NO
/AE	Assign analogue output for generic function - see /AA	0	0	2	-	S	NO
/AF	Assign analogue output for modulating lights - see /AA	0	0	2	-	S	NO
/AG	Assign analogue output for modulating compressor - see /AA	0	0	2	-	S	NO

6.5 Digital outputs

iJF features up to 6 digital outputs - NO1 to NO6. To associate the digital outputs with the available functions, set parameters DOA, DOB, ... DOZ to the value of the physical digital output. See the parameter table.

Digital output functions

Digital output assignment for:	Par.	Default iJF small	Default iJF large
Solenoid/compressor	DOA	Digital output 1 (NO1)	Digital output 5 (NO5)
Alarm	DOb	-	Digital output 2 (NO2)
Auxiliary	DOC	-	Digital output 1 (NO1)
Light	DOE	Digital output 4 (NO4)	Digital output 3 (NO3)
Defrost	DOG	Digital output 2 (NO2)	Digital output 6 (NO6)
Auxiliary evaporator defrost	DOH	-	-
Evaporator fans	DOI	Digital output 3 (NO3)	Digital output 4 (NO4)
Dehumidification	DOj	-	-
Auxiliary compressor without rotation	DOK	-	-
Liquid valve	DOn	-	-
Condensate drain heater	DOP	-	-
Anti-sweat heater	DOQ	-	-
Generic digital output	DOS	-	-
Condenser fans	DOt	-	-
Humidifier	DOU	-	-
Heading in dead band	DOv	-	-
Auxiliary parallel compressor	DOw	-	-
Gasket heater	DOx	-	-
Auxiliary compressor with rotation	DOy	-	-
External dehumidifier	DOz	-	-

Tab. 6.f

If the opposite logic to the default setting is required, or to correct a wiring error, the logic of the functions associated with the digital outputs using parameters rOA, rOb, ... rOz can be reversed.

Code	Description	Def	Min	Max	UOM	User	User terminal
rOA, rOb, ..., rOz	Digital output logic: 0=direct; 1=reverse	0	0	1	-	S	NO

Solenoid/compressor (par. DOA)

This is used to assign the compressor or liquid solenoid valve output.

Par.	Description	Def	Min	Max	UOM	User	User terminal
DOA	Assign solenoid/compressor digital output	1 (small)	0	6	-	S	NO
	0 = not configured	4 = digital output 4 (NO4)					
	1 = digital output 1 (NO1)	5 = digital output 5 (NO5)					
	2 = digital output 2 (NO2)	6 = digital output 6 (NO6)					
	3 = digital output 3 (NO3)						

Alarm (par. DOB)

This is used to assign the alarm output. The relay associated with the alarm function can work as follows:

- normally de-energised: the relay is energised when an alarm occurs (rOA = 0);
- normally energised: the relay is de-energised when an alarm occurs (rOA = 1);

 **Notice:** operation with the relay normally energised (rOA = 1) when an alarm occurs ensures maximum safety when the alarm is due to a power failure or power cable disconnection.

Par.	Description	Def	Min	Max	UOM	User	User terminal
DOB	Assign alarm digital output - see DOA	0 (small)	0	6	-	S	NO
		2 (large)					

AUX auxiliary output (par. DOC)

The relay can be activated/deactivated from the supervisor and on changeover between day/night status (linked to the curtain switch or the time band settings). Activation/deactivation of the actuator is signalled by the icon switching on/off (if present). The AUX output to be activated or deactivated based on the night/day time band can be selected (see parameters tS1...8, tE1...8 and H8).

Par.	Description	Def	Min	Max	UOM	User	User terminal
DOC	Assign AUX auxiliary digital output - see DOA	0 (small)	6	-	S	NO	
		1 (large)					

Light (par. DOE)

The relay can be activated/deactivated using the direct functions on the user terminal, from the supervisor and on changeover between day/night status (linked to the curtain switch or the time band settings). Activation/deactivation of the actuator is signalled by the light icon switching on/off (if present). The light output to be activated or deactivated based on the night/day time band can be selected (see parameters tS1...8, tE1...8 and H8).

Par.	Description	Def	Min	Max	UOM	User	User terminal
DOE	Assign light digital output - see DOA	4 (small)	0	6	-	S	NO
		3 (large)					

Defrost (par. DOG)

The relay is activated/deactivated based on the defrost settings (see "Defrost"). Activation/deactivation of the actuator is signalled by the defrost icon switching on/off on the user terminal (if present).

Auxiliary evaporator defrost (par. DOH)

The relay is activated/deactivated based on the defrost settings (see "Defrost").

Par.	Description	Def	Min	Max	UOM	User	User terminal
DOH	Assign auxiliary evaporator defrost digital output - see DOA	...	0	6	-	S	NO

Evaporator fans (par. DOI)

The relay is activated/deactivated based on the evaporator fan settings (see "Evaporator fans"). Activation/deactivation of the relay is signalled by the evaporator fan icon switching on/off on the display (if present).

Par.	Description	Def	Min	Max	UOM	User	User terminal
DOI	Assign evaporator fan digital output - see DOA	3 (small)	0	6	-	S	NO
		4 (large)					

Dehumidification (par. DOJ)

Select the digital output used to manage the dehumidification function. See "Control".

Par.	Description	Def	Min	Max	UOM	User	User terminal
DOJ	Assign dehumidification digital output - see DOA	...	0	6	-	S	NO

Auxiliary compressor without rotation (par. DOK)

Select the output for the auxiliary compressor without rotation (see "Control"). Setting this output enables an auxiliary compressor that is activated as a second control step, without rotation, i.e. always switching on after the main compressor. In the event of simultaneous request for both steps, the auxiliary compressor is activated after a delay time set by parameter c11, to avoid simultaneous starts.

Par.	Description	Def	Min	Max	UOM	User	User terminal
DOK	Assign auxiliary compressor without rotation digital output - see DOA	...	0	6	-	S	NO
c11	Second compressor start delay	4	0	250	s	M	NO

Pump down valve (par. DOn)

Digital output for pump down valve management.

Par.	Description	Def	Min	Max	UOM	User	User terminal
DOn	Assign pump down valve digital output - see DOA	...	0	6	-	S	NO

Condensate drain heater (par. DOP)

During defrosting there may be frozen condensate on the bottom of the cabinet that prevents the water thawed from the evaporator from being drained correctly. The digital output can be configured to manage the condensate drain heater function. The heater is switched on before defrosting (dHA) and remains on after the defrost ends, for the time dHE. The heater can be activated by selecting a digital output with par. DOP.

Notice: the heater must be protected against overheating (e.g. thermal protector).

Par.	Description	Def	Min	Max	UOM	User	User terminal
DOP	Assign drain heater digital output - see DOA	...	0	6	-	S	NO
dHA	Drain heater activation time before defrosting	3	1	120	min	M	No
dHE	Drain heater activation time after defrosting	3	1	120	min	M	No

Anti-sweat heater (par. DOQ)

Select the digital output for demisting the glass (see "Anti-sweat heater or fan").

Par.	Description	Def	Min	Max	UOM	User	User terminal
DOQ	Assign anti-sweat heater digital output - see DOA	...	0	6	-	S	NO

Generic function output (par. DOS)

Select the digital output for the generic function with ON/OFF output (see "Generic functions").

Par.	Description	Def	Min	Max	UOM	User	User terminal
DOS	Assign generic function digital output - see DOA	...	0	6	-	S	NO

Condenser fans (par. DOT)

The relay is activated/deactivated based on the condenser fan settings (see "Condenser fans").

Par.	Description	Def	Min	Max	UOM	User	User terminal
DOT	Assign condenser fan digital output - see DOA	...	0	6	-	S	NO

Humidifier output (par. DOu)

Select the humidification output (see "Humidity management").

Par.	Description	Def	Min	Max	UOM	User	User terminal
DOu	Assign humidification digital output - see DOA	...	0	6	-	S	NO

Reverse dead band output (par. DOv)

Select reverse output for dead band control (see "Control").

Par.	Description	Def	Min	Max	UOM	User	User terminal
DOv	Assign reverse digital output with dead band control - see DOA	...	0	6	-	S	NO

Auxiliary parallel compressor (par. DOW)

Select the auxiliary parallel compressor output (see "Control"). Setting this output enables an auxiliary compressor that works in parallel with the main compressor. A delay time can be set using parameter c11 to avoid simultaneous starts.

Par.	Description	Def	Min	Max	UOM	User	User terminal
DOW	Assign auxiliary parallel compressor digital output - see DOA	...	0	6	-	S	NO
c11	Second compressor start delay	4	0	250	s	M	NO

Gasket heater (par. DOx)

Select the digital output for the door gasket heater (see "Gasket heater").

Par.	Description	Def	Min	Max	UOM	User	User terminal
DOx	Assign gasket heater digital output - see DOA	...	0	6	-	S	NO

Auxiliary compressor with rotation (par. DOy)

Select the output for the auxiliary compressor with rotation (see "Control"). Setting this output enables an auxiliary compressor that is activated as a second control step, with rotation, i.e. alternating with the compressor that starts first so as to balance the operating hours of the two compressors. In the event of simultaneous request for both steps, the second compressor is activated after a delay time set by parameter c11, to avoid simultaneous starts.

Par.	Description	Def	Min	Max	UOM	User	User terminal
DOy	Assign auxiliary compressor with rotation digital output - see DOA	...	0	6	-	S	NO
c11	Second compressor start delay	4	0	250	s	M	NO

External dehumidifier (par. DOz)

Select the digital output for activation of an external dehumidifier (see "Humidity management").

Par.	Description	Def	Min	Max	UOM	User	User terminal
DOz	Assign external dehumidifier digital output - see DOA	...	0	6	-	S	NO

6.5.1 Test output mode

The iJF control provides the possibility to test the operation of the analogue and digital outputs, either from the configuration tool or via the Applica app, by accessing Service area > Test mode.

Par.	Description	Def	Min	Max	UOM	User	User terminal
MA1	Test mode, activate analogue output 1: 0 = disabled; 1 = automatic; 2 = activated at the value of MA1	0	0	1	-	S	NO
MA2	Test mode, activate analogue output 2 - see MA1	0	0	1	-	S	NO
MAr1	Test mode, analogue output 1 request	0	0	100	%	S	NO
MAr2	Test mode, analogue output 2 request	0	0	100	%	S	NO
Mr1	Test mode, activate relay 1: 0 = disabled; 1 = automatic; 2 = activated	1	0	2	-	S	NO
Mr2	Test mode, activate relay 2 - see Mr1	1	0	2	-	S	NO
Mr3	Test mode, activate relay 3 - see Mr1	1	0	2	-	S	NO
Mr4	Test mode, activate relay 4 - see Mr1	1	0	2	-	S	NO
Mr5	Test mode, activate relay 5 - see Mr1	1	0	2	-	S	NO
Mr6	Test mode, activate relay 6 - see Mr1	1	0	2	-	S	NO
Mt	Manual mode duration (0 = manual mode always active)	10	0	90	min	S	NO

Parameters Mr* are used to activate the relays manually:

- Mr* = 0 the corresponding relay is deactivated;
- Mr* = 1 the corresponding relay is activated/deactivated automatically by the controller based on the associated function;
- Mr* = 2 the corresponding relay is activated.

Parameters MA* are used to activate the analogue outputs manually:

- MA* = 0 the corresponding output is deactivated;
- MA* = 1 the corresponding output is activated/deactivated automatically by the controller based on the associated function;
- MA* = 2 the corresponding output is activated at the value set by parameter MAr*.

The message 'Man' is shown on the display when at least one output is set in manual mode.

After a time set using parameter Mt, automatic operation resumes.

 **Caution:** if Mt = 0 operation remains in manual mode until automatic operation resumes.

Test outputs via BMS serial port

On iJF models with the BMS serial option, output test mode can also be activated via the BMS serial port. To activate test mode, a certain value needs to be sent within 60 s from controller power on, using the Modbus address assigned for enabling the test function (see the table). The value to be sent is 0x00A5, alternating with 0x005A every 30 s. When the iJF controller receives the value 0x00A5 alternating with 0x005A, the inputs are read and control is active as normal, however the outputs are overridden manually with the values set using parameters RelayActTestMode [1] to AoutActTestMode [2].

In test mode via BMS serial port, the display shows the message tSt.

Test mode ends when the value 0x00A5/0x005A is no longer updated within 30 s (in this case, the controller needs to be restarted) or when one of the following values is written:

- 0x0039: test mode ends and the controller is restarted.
- 0x0089: test mode ends without the controller restarting.

Par.	Description	Modbus						Register (dec.)	Register (hex.)	Address (hex.)	Access (**)
		Def.	Min	Max	UOM	Type (*)					
RelayActTestMode[1]	Test via BMS serial port activate relay 1	0	0	1	-	CS	5	0x0005	0x0004	R/W	
RelayActTestMode[2]	Test via BMS serial port activate relay 2	0	0	1	-	CS	6	0x0006	0x0005 R	/W	
RelayActTestMode[3]	Test via BMS serial port activate relay 3	0	0	1	-	CS	7	0x0007	0x0006	R/W	
RelayActTestMode[4]	Test via BMS serial port activate relay 4	0	0	1	-	CS	8	0x0008	0x0007	R/W	
RelayActTestMode[5]	Test via BMS serial port activate relay 5	0	0	1	-	CS	9	0x0009	0x0008	R/W	
RelayActTestMode[6]	Test via BMS serial port activate relay 6	0	0	1	-	CS	10	0x000A	0x0009	R/W	
CompFreqActTestMode	Test via BMS serial port VCC compressor frequency	0	0	255	hz	HR	49	0x0031	0x0030	R/W	
AoutActTestMode[1]	Test via BMS serial port value of analogue output Y1:	0	0	1000	% x 10	HR	83	0x0053	0x0052	R/W	
AoutActTestMode[2]	Test via BMS serial port value of analogue output Y2:	0	0	1000	% x 10	HR	84	0x0054	0x0053	R/W	
TestMode	Enable test via BMS serial port	0	0	255	-	HR	60	0x003C	0x003B	R/W	

Tab. 6.g

(*) CS= Coil Status; HR = Holding Register

(**) R = read; W = write

6.6 Control

Various modes are available for controlling the air temperature for the preservation of foodstuffs, depending on which probes are installed and their position. The following figure shows the position of the intake probe (air on) Sr and the outlet probe (air off) Sm. The virtual probe Sv is a weighted average of these two probes, based on parameter /4, according to the following formula:

$$Sv = \frac{Sm \cdot (100 - /4) + Sr \cdot (/4)}{100}$$

Par.	Description	Def	Min	Max	UOM	User	User terminal
/4	Virtual probe composition: 0 = Outlet probe Sm; 100 = Intake probe Sr	0	0	100	%	S	NO

For example, if /4=50, Sv=(Sm+Sr)/2 represents an estimated value of the air temperature around the refrigerated food.

Notice: HACCP: parameter /4 can be set to change the temperature used for control and for display. This operation may be prohibited by HACCP procedures or require record keeping and authorisation.

Example: vertical showcase

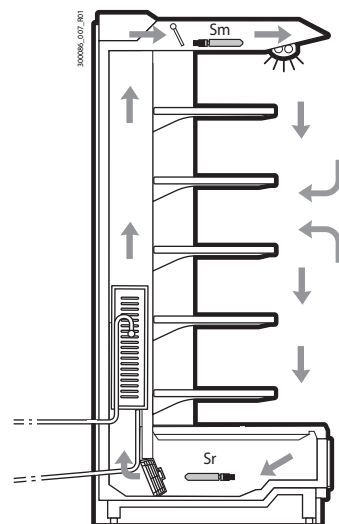

Fig. 6.b

Ref.	Description
Sm	Outlet probe
Sr	Intake probe
Sv	Virtual probe

During the day, most of the load in a refrigerated showcase is due to warm air that enters from the outside and mixes with the cold air inside. Control based on the intake probe, due to high temperature outside the showcase and the mixing of the air, may not manage to reach the set point. Displaying the intake temperature would show a temperature that is too high. Setting a set point that is too low for the intake probe S_r may cause the food to freeze. On the other hand, displaying the outlet temperature would show a temperature that is too low. Consequently, the display of the control probe, set point or virtual probe can be configured using parameter /t1.

ON/OFF control on the outlet probe is defined by:

- set point;
- differential

These values determine the control request and consequently, allowing for the protection times, disabling functions or activation/deactivation delays, the activation/deactivation of the compressor.

Par.	Description	Def	Min	Max	UOM	User	User terminal
St	Temperature control set point	50/122	r1	r2	°C/°F	U	YES
rd	Temperature control differential	2/3.6	0.1/0.2	99.9/179.2	Δ °C/°F	S	YES



Notice HACCP: the set point and differential are critical parameters for food storage.

Modifications to these settings may be prohibited by HACCP procedures or require record keeping and authorisation. The minimum and maximum value of the set point can be set by parameter.

Par.	Description	Def	Min	Max	UOM	User	User terminal
r1	Minimum set point	-50/-58	-99/-146.2	r2	°C/°F	S	NO
r2	Maximum set point	50/122	r1	200/392	°C/°F	S	NO

Control offset with probe error

Par.	Description	Def	Min	Max	UOM	User	User terminal
ro	Control offset with probe error	0	0	20/36	Δ °C/°F	M	NO

The iJF controller in standard mode uses the virtual probe S_v for control, that is, the weighted average of the outlet and intake probe (see parameter /4). If one of the two probes making up the virtual probe is broken or has an error, parameter ro is used to continue normal control in controlled conditions, without the need for immediate intervention by maintenance personnel. The recommended value of ro is the temperature difference between the outlet probe and intake probe reading in steady operating conditions of the refrigeration unit:

$$ro = Sr - Sm$$

The following cases may occur:

- outlet probe S_m error: control starts based on the intake probe S_r alone, considering a new set point (St^*) determined by the formula:

$$St^* = St + ro \cdot \frac{(100 - '/4')}{100}$$

- intake probe S_r error: based starts on the outlet probe S_m alone, considering a new set point (St^*) determined by the formula:

$$St^* = St - ro \cdot \frac{'/4'}{100}$$



Notice:

- if $ro = 0$ the function is not active;
- for night-time operation the new set point is added to the value defined by $r4$ (= automatic night-time set point variation);
- in the event of errors on both probes, the controller switches to duty setting operation.

Example

S_m fault in daytime operation, with /4=50, $St=-4$, $S_r=0$, $S_m=-8$, ro (recommended) = $0 - (-8) = 8$.

Then the new control probe will be S_r with:

$$St^* = St + ro \cdot \frac{(100 - '/4')}{100}$$

$$St^* = -4 + 8 \cdot (100 - 50) / 100 = 0.$$

If the fault is on S_r , the new control probe will be S_m with:

$$St^* = St - ro \cdot \frac{'/4'}{100}$$

$$St^* = -4 - 8 \cdot 50 / 100 = -8.$$

Duty setting operation

Duty setting is a special function used to maintain control in emergency situations with errors in the temperature control probes, until a service intervention.

In the event of a temperature probe error, the controller uses the other probe available and adjusts the set point according to the setting of parameter ro. In the event of errors on both probes, the controller switches to a special mode called “duty setting”. Control is activated at regular intervals, operating for a time equal to the value set for the duty setting parameter c4, and off for a fixed time of 15 minutes.

Par.	Description	Def	Min	Max	UOM	User	User terminal
c4	ON time for duty setting operation (Toff = 15 minutes, fixed value): 0 = compressor/valve always OFF; 100 = compressor/valve always ON.	0	0	100	min	M	NO

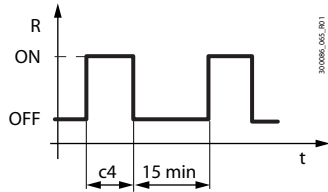

Ref.	Description
R	Control
c4	ON time
t	Time

Fig. 6.c

With duty setting active, during the ON time the solenoid/compressor icon remains on, while it flashes during the OFF time. The table below describes the possible fault situations relating to the control probes and the function that is activated.

Type of system	Control probe fault		Control	Parameter
	Sm	Sr		
1 probe	●		Duty setting	c4
		●	Duty setting	c4
2 probes	●		control on Sr	ro(*)
		●	control on Sm	ro(*)
	●	●	Duty setting	c4

Tab. 6.a

* Only when ro>0.

6.7 Control modes

Three control modes are available, based on the setting of parameter r30:

- r30 = 0, direct with defrost control (default);
- r30 = 1 direct;
- r30 = 2 reverse; operation suitable for hot food showcases;

Par.	Description	Def	Min	Max	UOM	User	User terminal
r30	Control mode: 0 = direct with defrost; 1 = direct; 2 = reverse	0	0	2	-	M	NO

The figure shows the behaviour of direct and reverse mode. The difference between direct control and direct control with defrost control is that in the former case defrosting is disabled, while in the latter case it is enabled; defrosting is enabled by default.

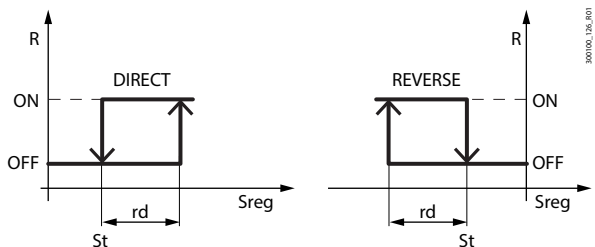

Ref.	Description
St	Set point
rd	Differential
Sreg	Control probe
R	Control request

Fig. 6.d

ON/OFF control depends on the capacity of the produce to absorb and release heat, as well as on the evaporator cooling time. The temperature therefore fluctuates above and below the set point, and this may cause a decline in the quality of food preservation. Decreasing the differential to make control more precise increases the frequency of compressor on/off cycles. Precision of the measurement is in any case limited by the tolerance of both the controller and the probe.

6.7.1 Control with auxiliary compressor

In addition to the main compressor, the iJF controller can manage a second compressor output that either acts as a second control step, with or without rotation, or in parallel with the main compressor:

- auxiliary compressor without rotation (parameter DOK)
- auxiliary compressor with rotation (parameter DOy)
- parallel compressor without rotation (parameter DOW)

Stepped control

Control with the auxiliary compressor enabled is illustrated in the figure. If the auxiliary compressor is configured without rotation (par. DOK), the main compressor is always activated first, while if the auxiliary compressor is configured with rotation (par. DOy), on each activation request the compressor that starts first is alternated, with FIFO rotation, so as to balance the operating hours of the two compressors.

The auxiliary compressor is activated with a delay that can be set using parameter c11, to avoid simultaneous starts.

Par.	Description	Def	Min	Max	UOM	User	User terminal
c11	Second compressor start delay	4	0	250	s	M	NO
DOA	Assign solenoid/compressor digital output 0 = Function disabled 1 = NO1; 2 = NO2; 3 = NO3; 4 = NO4	1 (small)/ 5 (large)	0	6	-	M	NO
DOK	Assign auxiliary compressor without rotation digital output 0 = Function disabled 1 = NO1; 2 = NO2; 3 = NO3; 4 = NO4	0	0	6	-	M	NO
DOy	Assign auxiliary compressor with rotation digital output 0 = Function disabled 1 = NO1; 2 = NO2; 3 = NO3; 4 = NO4	0	0	6	-	M	NO

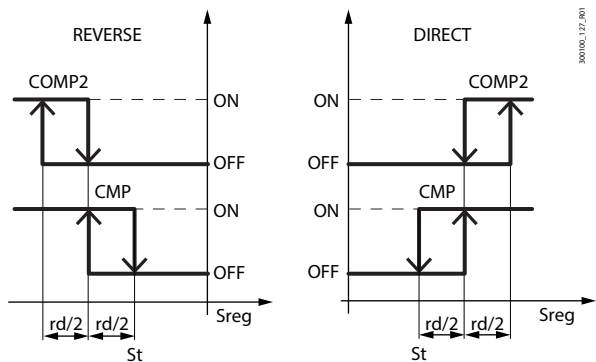

Ref.	Description
St	Set point
rd	Differential
Sreg	Control probe
CMP	Compressor request
CMP2	Auxiliary compressor request

Fig. 6.e

Parallel control

If the second compressor is configured as an auxiliary parallel compressor, control behaviour and activation of the two outputs are shown in the figure. The delay set by parameter c11 is always observed.

Par.	Description	Def	Min	Max	UOM	User	User terminal
c11	Second compressor start delay	4	0	250	s	M	NO
DOW	Assign auxiliary parallel compressor digital output - see DOA	0	0	6	-	M	NO

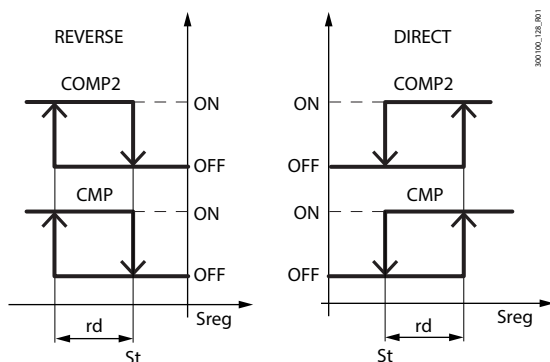

Ref.	Description
St	Set point
rd	Differential
Sreg	Control probe
CMP	Compressor request
CMP2	Auxiliary parallel compressor request

Fig. 6.f

6.7.2 Dead band control

If a digital output has been configured for reverse control in the dead band (par. DOv), control takes into account a dead band around the set point, with an amplitude that can be set using parameter rn. The reverse output is activated with a differential set using parameter rr. Control with dead band varies according to the control mode selected using parameter r30 and whether or not the second auxiliary or parallel compressor is available. The figures show the different behaviour with or without an auxiliary compressor; the behaviour with parallel compressor is similar to when the main compressor only is used.

For the auxiliary compressor, the delay set by parameter c11 is always observed.

Par.	Description	Def	Min	Max	UOM	User	User terminal
r30	Control mode: 0 = direct with defrost; 1 = direct; 2 = reverse	0	0	2	-	M	NO
rn	Dead band	4.0	0.0	60.0 /108	°C/°F	S	NO
rr	Reverse output differential	2.0	0.0	20.0 /36	°C/°F	S	NO
DOv	Assign reverse digital output with dead band 0 = Function disabled 1 = NO1; 2 = NO2; 3 = NO3; 4 = NO4	0	0	6	-	M	NO

Direct control in dead band without auxiliary compressor

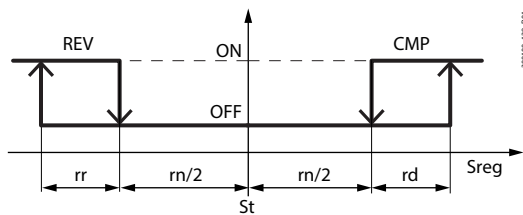

Fig. 6.g

Ref.	Description
St	Set point
rd	Differential
rn	Dead band
rr	Reverse output differential
Sreg	Control probe
CMP	Compressor request
REV	Reverse output request in dead band
COMP2	Auxiliary compressor request (par. DOK or par. DOy)

Direct control in dead band with auxiliary compressor

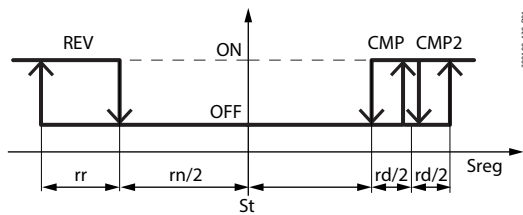

Fig. 6.h

Ref.	Description
St	Set point
rd	Differential
rn	Dead band
rr	Reverse output differential
Sreg	Control probe
CMP	Compressor request
REV	Reverse output request in dead band
COMP2	Auxiliary compressor request (par. DOK or par. DOy)

Reverse control in dead band without auxiliary compressor

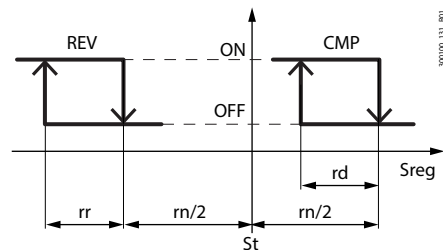

Fig. 6.i

Ref.	Description
St	Set point
rd	Differential
rn	Dead band
rr	Reverse output differential
Sreg	Control probe
CMP	Compressor request
REV	Reverse output request in dead band
COMP2	Auxiliary compressor request (par. DOK or par. DOy)

Reverse control in dead band with auxiliary compressor

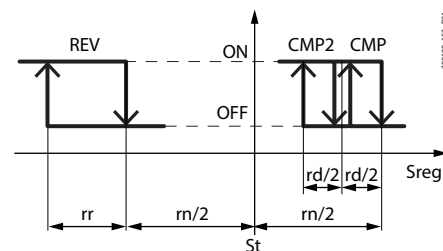

Fig. 6.j

Ref.	Description
St	Set point
rd	Differential
rn	Dead band
rr	Reverse output differential
Sreg	Control probe
CMP	Compressor request
REV	Reverse output request in dead band
COMP2	Auxiliary compressor request (par. DOK or par. DOy)

6.8 Night-time operation

During night-time operation there may be a decrease in thermal load. To avoid excessively low temperatures and high energy consumption, the set point needs to be increased at night by setting parameter r4. Parameter r6a can then be used to select the virtual probe Sv or intake probe Sr as the control probe.

	Daytime operation		Night-time operation	
			r6a = 0	r6a = 1
Control probe	Sv		Sv	Sr
Set point	St		St + r4	St + r4

Tab. 6.h

Night-time operation can be activated by a digital input configured as a curtain switch, on the user interface, from the supervisor or time bands, with different priorities. If the digital input has been selected, this has the highest priority and the other actions are ignored, while if the digital input has not been selected, the other actions have the same priority and the last one controls the action.

To set the time bands, see “Setting the date/time and time bands”.

Par.	Description	Def	Min	Max	UOM	User	User terminal
DIG	Assign curtain switch digital input - see DIA	0	0	4	-	S	NO
H8	Output switched with time bands 0 = Light; 1 = AUX.	0	0	1	-	M	NO
r4	Automatic night set point variation	0	-50/-90	50/90	°C/°F	S	NO
r6	Control probe for night-time operation: 0 = virtual probe Sv; 1 = intake temperature probe Sr	0	0	1	-	S	NO
r4d	Night control differential	4/7.2	0.1/0.2	99.9/ 179.2	°C/°F	S	NO
tS1..8-d	Start time band 1 to 8 day: day - see (td1...8-d)	0	0	11	day	U	NO
tS1..8-hh	Start time band 1 to 8 day: hours	0	0	23	hours	U	NO
tS1..8-mm	Start time band 1 to 8 day: minutes	0	0	59	minutes	U	NO
td1..8-time	Start time band 1 to 8: type of time data for Applica	00:00:00	00:00:00	23:59:59	-	U	NO
tE1..8-d	End time band 1 to 8 day: day - see (td1...8-d)	0	0	11	day	U	NO
tE1..8-hh	End time band 1 to 8 day: hours	0	0	23	hours	U	NO
tE1..8-mm	End time band 1 to 8 day: minutes	0	0	59	minutes	U	NO

Notice HACCP: verify that modification of the night-time set point (parameter r4) is permitted by site HACCP procedures. If required, obtain the required authorisation and record the changes.

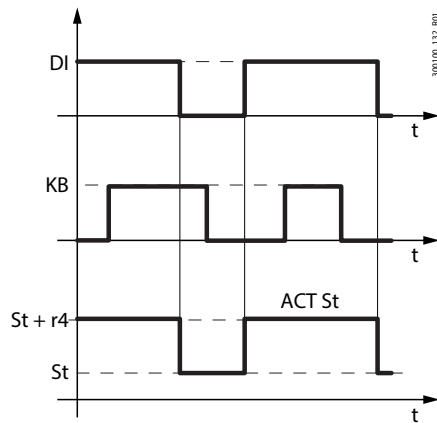

Fig. 6.k

Ref.	Description
St	Set point
r4	Night set point variation
DI	Control from digital input
ACT St	Effective set point
t	time

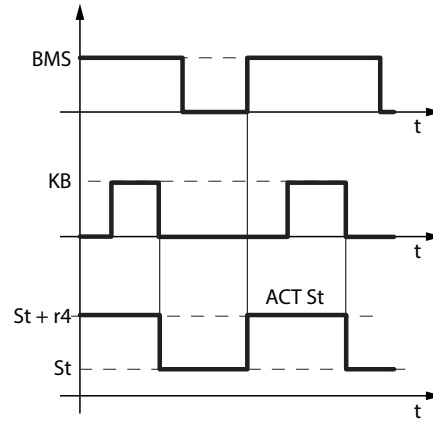

Fig. 6.l

Ref.	Description
St	Set point
r4	Night set point variation
BMS	Control from supervisor
KB	Control from keypad
t	time

By setting the time bands and setting the light as the switched output (H8 = 0), the set point follows the day/night settings of the time bands:

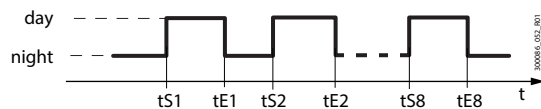

Fig. 6.m

During day status:

- Set point= St
- Regulation probe Sv
- light on

During night status:

- Set point= St + r4
- Regulation probe Sv or Sr, according r6a
- light on

6.9 ECO operation

During ECO operation, the iJF uses the same control set point $St+r4$, but with a different differential. This reduces the number of compressor starts/stops and reduces energy consumption.

ECO operation can be activated on the user interface, from the supervisor or time bands, with the same priority. To set the time bands, see "Setting the date/time and time bands".

Note: the time bands for ECO operation and night operation are the same; the effect depends on the setting of parameters $r4$ and $r4d$.

Par.	Description	Def	Min	Max	UOM	User	User terminal
rd	Temperature control differential	2 / 3.6	0.1/0.2	99.9/ 179.2	Δ °C/°F	S	YES
$r4d$	Night control differential	4/7,2	0.1/0.2	99.9/ 179.2	Δ °C/°F	S	NO
$tS1..8-d$	Start time band 1 to 8 day: day - see (td1...8-d)	0	0	11	day	U	NO
$tS1..8-hh$	Start time band 1 to 8 day: hours	0	0	23	hours	U	NO
$tS1..8-mm$	Start time band 1 to 8 day: minutes	0	0	59	minutes	U	NO
$td1..8-time$	Start time band 1 to 8: type of time data for Applica	00:00:00	00:00:00	23:59:59	-	U	NO
$tE1..8-d$	End time band 1 to 8 day: day - see (td1...8-d)	0	0	11	day	U	NO
$tE1..8-hh$	End time band 1 to 8 day: hours	0	0	23	hours	U	NO
$tE1..8-mm$	End time band 1 to 8 day: minutes	0	0	59	minutes	U	NO

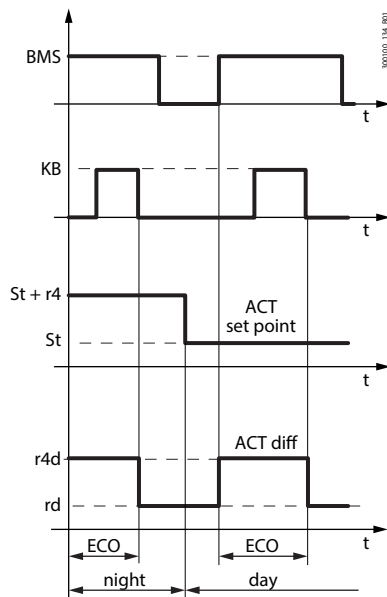

Ref.	Description
$r4d$	Differential in ECO operation
$r4$	Night set point variation
KB	Control from keypad
BMS	Control from supervisor
ACT Diff	Effective differential
ECO	ECO operation
night	Night-time operation
t	Time

Fig. 6.n

Notice: if the door switch digital input is configured, opening the door causes the changeover from ECO operation to normal operation.

6.10 Continuous cycle

Continuous cycle is a function used to keep the refrigeration cycle active continuously for a settable duration (parameter cc), irrespective of the temperature inside the unit. This may be useful when requiring a rapid decrease in the temperature, even below the set point. Continuous cycle ends when the time set for cc is reached or when the temperature falls below the set point by the value set for parameter ccE .

Caution: the unit of measure of parameter cc is hours.

Par.	Description	Def	Min	Max	UOM	User	User terminal
$c7$	Defrost priority over continuous cycle: 0 = same priority; 1 = defrost has priority.	0	0	1	-	M	NO
cc	Continuous cycle running time, 0 = disabled	0	0	15	h	M	NO
ccE	Set point delta to end continuous cycle	1.5 / 2.7	0.0	9.9/17.8	Δ °C/°F	M	NO

Continuous cycle can be activated by digital input, from the supervisor, on reaching the high temperature threshold AH or from the user interface. When the continuous cycle is running:

- the icon comes on (see "User interface" for details)
- the solenoid valve/compressor output (with icon) is activated;
- the low temperature alarm with threshold AL is enabled.

Notice:

1. the continuous cycle cannot be activated if:
 - the duration of the continuous cycle is set to 0 ($cc = 0$);
 - the temperature is below the control set point
 - the device is OFF.

2. The continuous cycle remains in standby if:
 - the compressor is waiting for the times to elapse (c1, c3);
 - the immediate or delayed alarm from external digital input is active;
 - defrost, dripping, post-dripping are running;
 - the door is open. When the door is opened, the continuous cycle is interrupted. It restarts for the remaining time when the door is closed.
3. The continuous cycle ends:
 - when deactivating the direct function from the user terminal (see "Direct functions");
 - when reaching the low temperature threshold (AL or AL2 with double thermostat), whichever is reached first;
 - at the end of the time cc;
 - when the controller is switched off from the supervisor (logical OFF);
 - from the supervisor.

The continuous cycle ends:

- on deactivation by digital input, from the supervisor or user interface;
- on reaching the time cc;
- on reaching the threshold St-ccE;
- when there is a defrost request (if c7 = 1);
- when the iJF controller is placed in OFF status.

Defrost priority over continuous cycle

Par.	Description	Def	Min	Max	UOM	User	User terminal
c7	Defrost priority over continuous cycle: 0 = same priority; 1 = defrost has priority.	0	0	1	-	M	NO

If c7 = 0, the continuous cycle has priority over defrosting: any defrost requests remain on hold while the continuous cycle is running. If c7=1, defrost requests that are activated when the continuous cycle is running terminate the latter and the defrost starts.

6.11 Custom set points

On the iJF controller the temperature and humidity set points can be selected from sets of preset values. This is done using the Applica app or the commissioning tools, by setting parameter St_idx. Furthermore, on some iJF models the set points can be changed directly by pressing a button or activating a direct function on the display. The preset set point values can be changed by setting parameters Sc1, Sc2, Sc3, Sh1, Sh2, Sh3 in the Applica app or commissioning tools.

Par.	Description	Def	Min	Max	UOM	User	User terminal
Sc1	Custom temperature set point 1	0	r1	r2	°C/°F	M	NO
Sc2	Custom temperature set point 2	0	r1	r2	°C/°F	M	NO
Sc3	Custom temperature set point 3	0	r1	r2	°C/°F	M	NO
St_idx	Custom set point index	0	0	3	-	M	NO
Sh1	Custom humidity set point 1	0	0	100	%RH	M	NO
Sh2	Custom humidity set point 2	0	0	100	%RH	M	NO
Sh3	Custom humidity set point 3	0	0	100	%RH	M	NO

6.12 Compressor

The iJF controller can manage both On/Off and modulating compressors (VCC - Variable Capacity Compressors, with serial command in the models with VCC option, or directly via the analogue output, appropriately configured). The control request is sent to the main compressor and the auxiliary compressor, as described in "Control".

6.13 Compressor protection times

The controller features the following compressor protection parameters.

Par.	Description	Def	Min	Max	UOM	User	User terminal
c0	Delay to enable solenoid/compressor and evaporator fans at power on	0	0	240	min	M	NO
c1	Min time between consecutive compressor starts	0	0	15	min	M	NO
c2	Min compressor OFF time	0	0	15	min	M	NO
c3	Min compressor ON time	0	0	15	min	M	NO
d9	Defrost priority over compressor protection times: 0 = compressor (the protection times are observed); 1 = defrost (the protection times are ignored, therefore defrosting has higher priority and overrides the compressor times).	10	0	1	-	M	NO

- c0 is used to delay the start of control when the device is powered on. This function is useful for protecting the compressor and the driving relay from repeated on cycles in the event of frequent voltage drops.
- c1 sets the minimum time between two successive starts of the compressor, irrespective of the request. This parameter can be used to limit the maximum number of starts per hour;
- c2 sets the minimum compressor off time. The compressor will not be started again until the minimum time set has elapsed;
- c3 sets the minimum compressor running time. The compressor will not be started again until the minimum time set has elapsed;
- d9 disables the compressor protection times when defrosting:
 - d9 = 0: the compressor protection times are observed;
 - d9 = 1: the compressor protection times are ignored, therefore defrosting has higher priority over the compressor protection times.

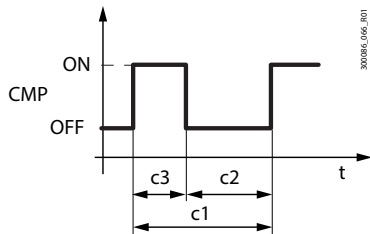

Fig. 6.o

Ref.	Description
CMP	Compressor
t	time

Notice: in the event of duty setting operation (see the corresponding paragraph), if the on time c4 is less than c3, the compressor remains on for the time c3.

6.14 Variable capacity compressor (VCC)

The iJF controller calculates the optimum compressor speed based on the value read by the control probe, and sends this data to the VCC inverter, which then drives the compressor, based on the model, in one of two modes: frequency or serial protocol.

6.14.1 VCC with frequency control

For frequency-controlled inverters, some iJF models are equipped with a dedicated analogue output. The output signal is a digital square wave, with a voltage amplitude from 0 to +10 Vdc and a range defined as described below. The duty cycle is 50%.

Par.	Description	Def	Min	Max	UOM	User	User terminal
/AG	Assign analogue output for modulating compressor - see /AA	0	0	2	-	S	NO
/P5	Configuration of analogue output Y1: 7 = 0-10 V; 8 = PWM.	8	7	8	-	S	NO
/P6	Configuration of analogue output Y2: 7 = 0-10 V; 8 = PWM.	8	7	8	-	S	NO

The analogue output to be used, Y1 or Y2, is selected by parameter /AG, with the corresponding parameter /P5 or /P6 then set as a PWM output.

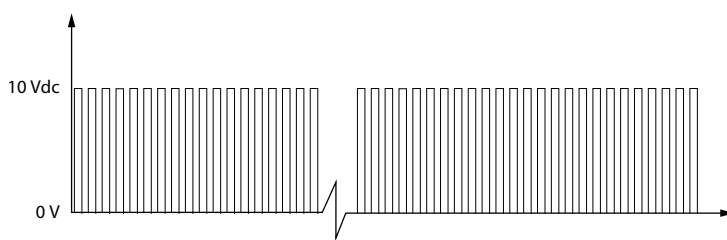

Fig. 6.p

The compressor speed follows the input frequency signal, with a relationship such as the one shown in the figure.

Notice: the reference frequencies and speeds vary according to the type of compressor and the parameter settings (see below).

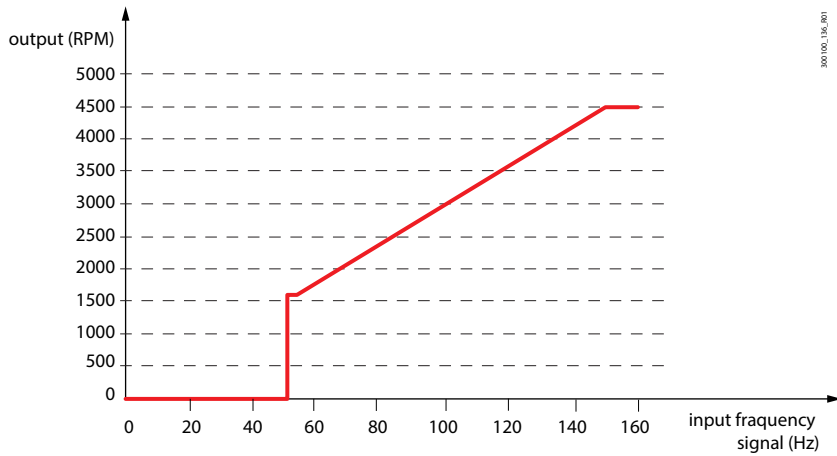

Fig. 6.q

The following diagrams show two examples of connection to the Embraco and Secop inverters. It is recommended to refer to the inverter manufacturer's user manual for more detailed instructions and installation instructions.

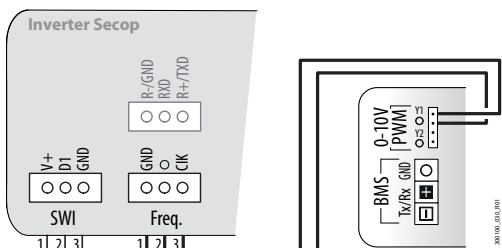

Fig. 6.r

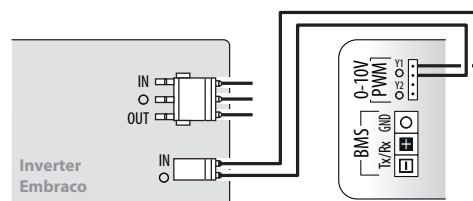

Fig. 6.s

6.14.2 VCC with serial control

For inverters with serial control, some iJF models feature a dedicated serial port. The inverter is connected directly, as shown in the following table. The following diagrams show two examples of connection to the Embraco and Secop inverters. It is recommended to refer to the inverter manufacturer's user manual for more detailed instructions and installation instructions.

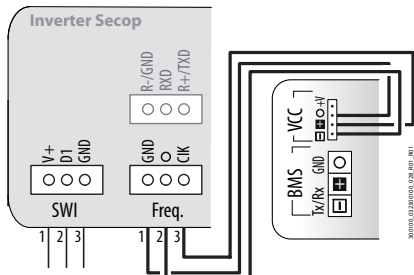

Fig. 6.t

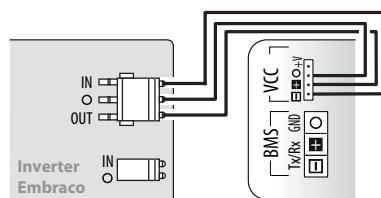

Fig. 6.u

Correspondence of terminals for serial connection

iJF	VCC	Secop	Embraco
+V	Not used	Not used	
GND	GND	O	
-	O	IN	
+	CIK	OUT	

Tab. 6.i

The serial communication protocol complies with the following technical specifications:

Asynchronous communication (start-stop)

Baud rate	600 baud
Start bits	1
Data bits	8
Stop bits	1
Parity	None
Flow control	None
Unit size	5 bytes 5 bytes

Tab. 6.j

The compressor speed is sent to the inverter via a specific serial protocol command. The compressor speed follows the sent value, with a relationship such as the one shown in the figure:

Notice: the reference frequencies and speeds vary according to the type of compressor and the parameter settings (see below).

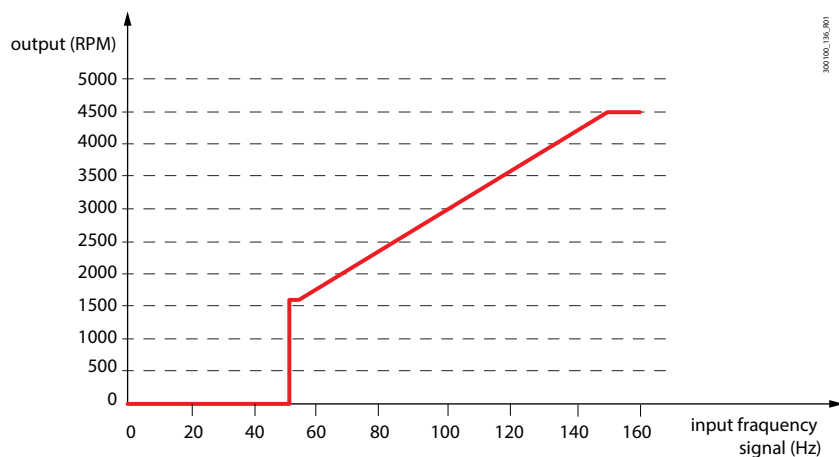

Fig. 6.v

6.14.3 VCC compressor configuration

All of the VCC configuration parameters are expressed in units of frequency (Hz). The corresponding compressor rotation speed (rpm) depends on the relationship:

$$\text{Compressor speed (rpm)} = \text{Frequency (Hz)} * \text{cuF}$$

where cuF is the conversion factor between frequency and compressor speed.

Par.	Description	Def.	Min	Max	UOM	User	User terminal
cdf	VCC compressor frequency for hot gas defrost	140	0	255	hz	M	NO
cMA	Maximum VCC compressor rotation frequency	150	0	250	hz	M	NO
cMf	Maximum VCC compressor control frequency	100	0	255	hz	M	NO
cMi	VCC compressor switch-off frequency	30	0	250	hz	M	NO
cnf	Minimum VCC compressor control frequency	100	0	255	hz	M	NO
cuF	Conversion factor from frequency (Hz) to compressor speed (rpm)	30	0	999	-	M	NO
cSc	Soft start frequency	53	0	255	hz	M	NO
cSt	Soft start time	5	0	999	s	M	NO

Each VCC model works between two operating limit frequencies, the switch-off frequency and the maximum rotation frequency. The iJF controller uses the following preset values:

- cMi = switch-off frequency = 30 Hz (thermostat present signal, but VCC is off, 0 rpm)
- cMA = maximum rotation frequency = 150 Hz (4500 rpm)

For VCCs that use values other than those shown previously, see “Advanced VCC configuration”.

To adapt the cooling capacity of the VCC to the actual needs of the application, set the following parameters:

- cnf = minimum control frequency; preset value = 52 Hz (1560 rpm);
- cMf = maximum control frequency; preset value = 100 Hz (3000 rpm).

During normal control, when the conditions require the VCC to restart, the compressor runs at the soft-start frequency for the soft-start time (a few seconds). To adapt this frequency to the VCC oil recovery specifications, set the following parameters:

- cSc = soft-start frequency; preset value = 53 Hz (1590 rpm);
- cSt = soft-start time; preset value = 5 s.

When defrosting, if set in hot gas mode, the compressor runs at a fixed frequency, defined by the following parameter:

- cdf = hot gas defrost frequency; preset value = 140 Hz (4200 rpm).

6.14.4 VCC compressor control

The VCC compressor speed is controlled using a PID algorithm. The compressor remains off until the control temperature exceeds the value St + rd, at which point the compressor starts at the soft-start frequency cSc. After the soft-start time cSt, the PID algorithm manages the compressor speed within the operating range defined by cnf and cMf.

Par.	Description	Def.	Min	Max	UOM	User	User terminal
cct	VCC compressor off time	1	0	250	min	M	NO
cdt	PID control derivative term	1	0	255	s	M	NO
cPr	PID control proportional term	2	0	800	-	M	NO
ctl	PID control integral term	120	0	999	s	M	NO

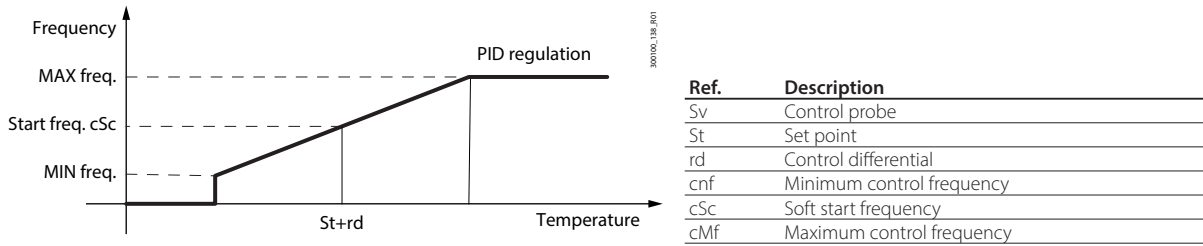

Fig. 6.w

The PID control algorithm can be adapted to the needs of the application by setting the following parameters:

- cPr = PID control proportional term;
- ctl = PID control integral term;
- cdt = PID control derivative term.

The preset values are suitable and safe for starting any application the first time. When making adaptations, it is recommended to modify one parameter at a time and check the behaviour of the application in a controlled environment.

If the compressor is on, the controller switches it off when the temperature read by the control probe Sv reaches the low temperature alarm threshold or the set point St for a time equal to cct:

- if cct is set to 0, the compressor stops immediately when Sv = St.
- if cct is set to 255, the compressor never stops.

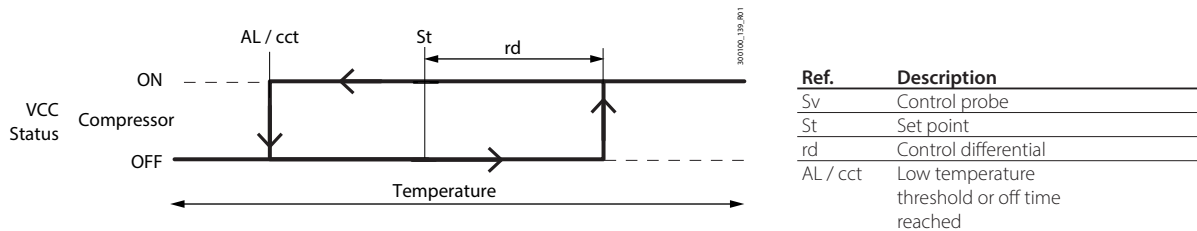

Fig. 6.x

To protect the refrigerated products, management of the two alarm thresholds overlaps normal control:

- AL = low temperature alarm threshold; when the temperature read by the control probe Sv is lower than the threshold AL, the controller immediately stops the compressor.
- AH = high temperature alarm threshold; when the temperature read by the control probe Sv is higher than the threshold AH, the controller activates the continuous cycle for the compressor (if cc > 0). See "Continuous cycle".

Par.	Description	Def.	Min	Max	UOM	User	User terminal
AH	High temperature alarm threshold	0	0	555/999	Δ °C/°F	U	YES
AHA	Absolute high temperature alarm threshold	537/999	-100 /-148	537/999	°C/°F	U	YES
AL	Low temperature alarm threshold	0	0	200/360	Δ °C/°F	U	YES
ALA	Absolute low temperature alarm threshold	-100/-148	-100 /-148	537/999	°C/°F	U	YES

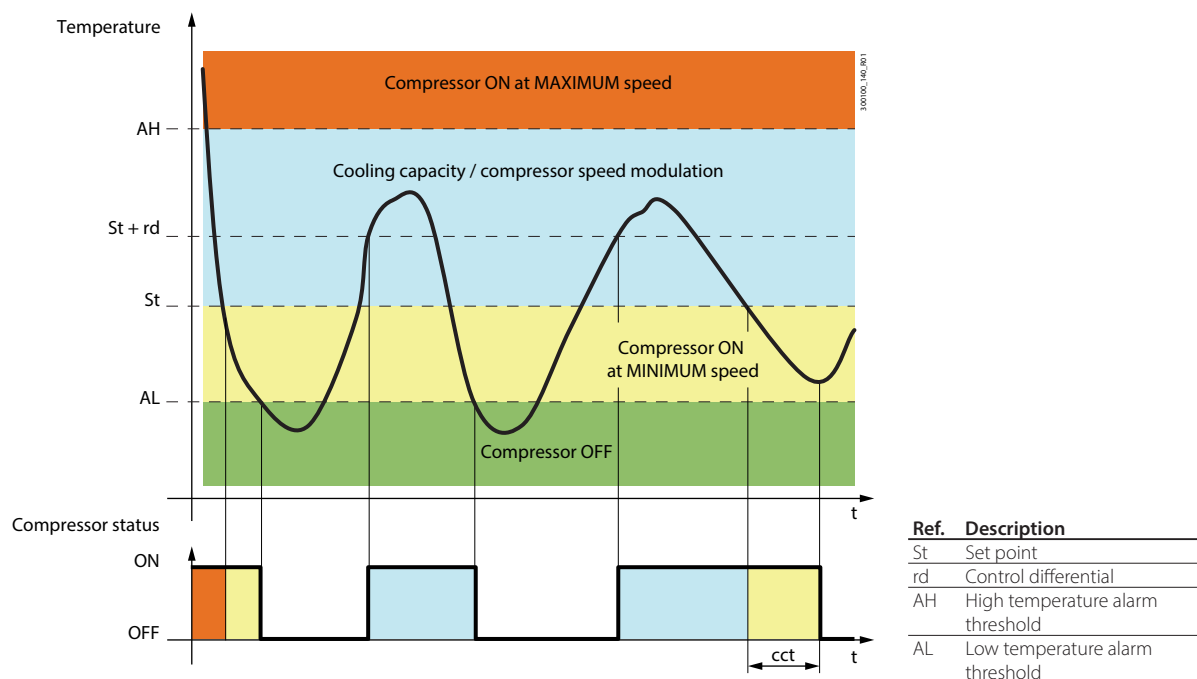

Fig. 6.y

6.14.5 Defrost with VCC compressor

When there is a hot gas defrost request, the variable speed compressor operates at the speed set by cdF. The defrost relay is delayed by the drain heater activation time dHA. At the end of the defrost, the compressor switches back to normal control and the drain heater remains on for the post-heating time dHE.

Notice: if at the end of the defrost the temperature is higher than the alarm threshold AH or AHA, and parameter cc > 0, the compressor is activated at the maximum frequency cMA to bring the temperature down in the shortest possible time.

The following diagram describes hot gas defrost with drain heater management.

Par.	Description	Def.	Min	Max	UOM	User	User terminal
cdF	VCC compressor frequency for hot gas defrost	140	0	255	hz	M	NO
ddF	VCC compressor frequency for dripping	140	cMi	255	hz	M	NO
dHA	Drain heater activation time before defrosting	3	1	120	min	M	NO
dHE	Drain heater activation time after defrosting	3	1	120	min	M	NO

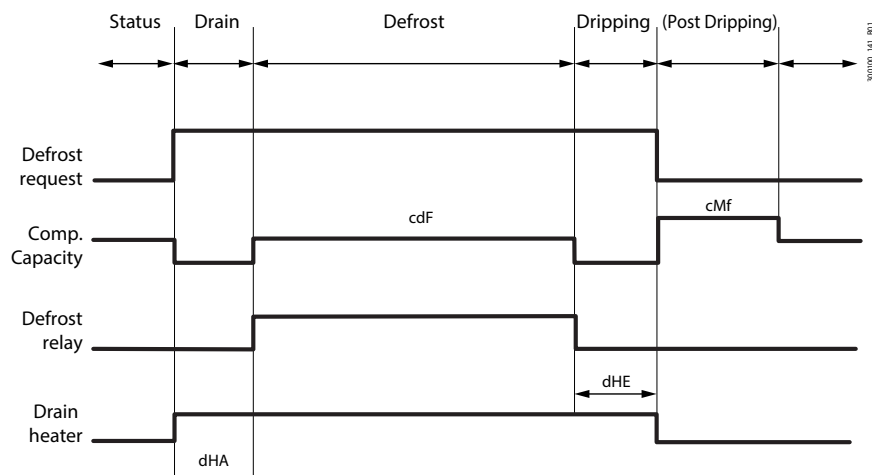

Fig. 6.z

6.14.6 Continuous cycle with VCC compressor

When the continuous cycle is activated, the compressor is switched on (if off, otherwise it stays on). The compressor runs at the speed set by parameter cMA until the end of the continuous cycle.

Par.	Description	Def.	Min	Max	UOM	User	User terminal
cMA	Maximum VCC compressor rotation frequency	150	0	250	hz	M	NO

6.14.7 Dead band and VCC compressor

If the reverse output is set for dead band control, the VCC compressor starts when $St + rn/2 + rd$, as described in "Dead band control". To activate the reverse output, the compressor must be off.

Par.	Description	Def.	Min	Max	UOM	User	User terminal
cct	VCC compressor off time	1	0	255	min	M	NO

Note the following:

- The compressor stops when the control temperature $Sv < St$ and the time cct elapses.
- If cct is set to 0, the compressor stops immediately when the temperature reaches the set point St
- If cct is set to 255, the compressor never stops and the reverse output can never be activated.

6.14.8 On/Off compressor and VCC compressor

If the auxiliary compressor without rotation is configured, the first compressor to be activated is the VCC, as described in "VCC compressor control". The On/Off compressor will be activated second.

Par.	Description	Def.	Min	Max	UOM	User	User terminal
c1	Min time between consecutive compressor starts	0	0	15	min	M	NO
c2	Min compressor OFF time	0	0	15	min	M	NO
c3	Min compressor ON time	0	0	15	min	M	NO

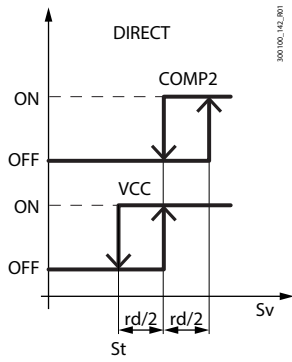

Fig. 6.aa

Ref.	Description
Sv	Control probe
St	Set point
rd	Control differential
VCC	VCC compressor request
COMP2	Auxiliary compressor request

The time set by parameter c11 is always observed between activation of the VCC compressor and activation of the On/Off compressor.

If the auxiliary compressor is configured as a parallel compressor, the auxiliary compressor is activated together with the VCC compressor, after the delay time c11.

6.15 Pump down

When the compressor stops, the pump down procedure can be performed to empty the evaporator. The pump down procedure can end by pressure or by time, as set by parameter c10.

Par.	Description	Def.	Min	Max	UOM	User	User terminal
cPt	Maximum pump down time (0 = pump down disabled)	s	0	900	0	M	NO
c8	Compressor start delay after opening the pump down valve	s	0	60	5	M	NO
c9	Restart during pump down: 0 = disabled; 1 = enabled.	-	0	1	1	M	NO
c10	Pump down by pressure or time: 0 = pressure; 1 = time.	0	1	1	-	M	NO
Dlt	Assign low pressure switch digital input: 0 = disabled; 1 = ID1; 2 = ID2; 3 = D1H; 4 = D2H	-	0	4	0	M	NO
DOn	Assign liquid valve digital output: 0 = disabled; 1 = NO1; 2 = NO2; 3 = NO3; 4 = NO4; 5 = NO5; 6 = NO6	-	0	6	0	M	NO

The pump down procedure can be activated if the liquid valve digital output is configured and parameter cPt > 0. When there is a request to stop the compressor, the liquid valve is closed until the low pressure switch is activated or the time cPt elapses, based on the setting of parameter c10.

If pump down is set to end by pressure and the pressure switch is not activated before the time cPt, the procedure is terminated when the time expires, and the Pump down ended after maximum time alarm Pd is generated.

Notice: for VCC compressors, during pump down the compressor is operated at the minimum frequency cnf.

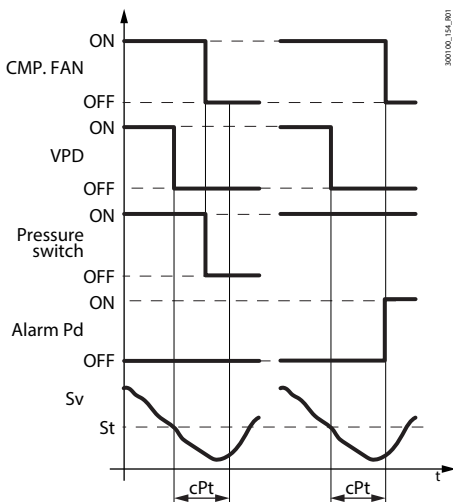

Fig. 6.ab

Ref.	Description
St	Set point
rd	Control differential
Sv	Control threshold
PRESSURE SWITCH	Low pressure switch
CMP, FAN	Compressor request
VPD	Liquid valve output
ALARM Pd	Pump down ended after maximum time alarm
cPt	Pump down time

Notice: for VCC compressors, take care when setting parameter cct for stopping the compressor. To perform the pump down procedure, set cct = 0.

If during pump down the status of the low pressure switch changes again and restart during pump down is enabled by setting parameter c9 = 1, the procedure ends, the compressor restarts and a Restart in pump down alarm Ats is generated. Alarm Ats is reset when a pump down procedure is completed correctly.

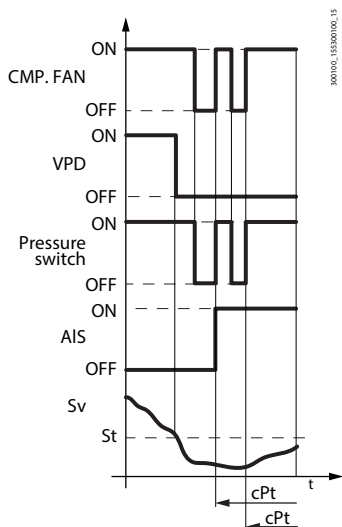

Fig. 6.ac

Ref.	Description
St	Set point
rd	Control differential
Sv	Control threshold
PRESSURE SWITCH	Low pressure switch
CMP, FAN	Compressor request
VPD	Liquid valve output
Ats	Restart in pump down alarm
cPt	Pump down time

When the compressor starts, the liquid valve is opened for the time set by parameter c8, to allow the pressure to equalise. If c8 = 0 pump down at power on is disabled.

6.16 Defrost

Introduction

The iJF controller can manage different types of defrosts, based on the setting of parameter d0.

The defrost can end by temperature, in which case the defrost probe Sd must be installed, or by time. At the end of the defrost the dripping phase may begin (if dd>0), during which the compressor and the fans are off, followed by the post-dripping phase (if Fd>0), during which control resumes and the fans work based on the setting of parameter Fpd. The type of display on user terminal during the defrost can be selected by setting parameter d6.

Code	Description	Def	Min	Max	UOM	User	User terminal
Dlc	Assign enable defrost digital input - see DIA	0	0	4	-	S	NO
Dld	Assign start defrost digital input - see DIA	0	0	4	-	S	NO
/d1	Assign end defrost probe:	2	1	16	-	M	YES
	1 outlet temperature (Sm)		9 ambient temperature				
	2 defrost temperature (Sd)		10 not used				
	3 intake temperature (Sr)		11 glass temperature				
	4 not used		12 not used				
	5 not used		13 condensing temperature				
	6 auxiliary evaporator defrost temperature (Sd2)		14 humidity				
	7 auxiliary probe 1		15 frost protection temperature				
	8 auxiliary probe 2		16 product temperature				
/d2	Assign auxiliary evaporator end defrost probe - see /d1	6	1	16	-	M	YES
d0	Type of defrost	0	0	4	-	M	NO
	0 heater by temperature		3 hot gas by time				
	1 hot gas by temperature		4 heater by time				
	2 heater by time		with temperature control				
dt1	End defrost temperature (read by Sd)	4/ 39.2	-50/ -58	50/122	°C/°F	S	YES
dt2	Auxiliary evaporator end defrost temperature (read by Sd2)	4/ 39.2	-50/ -58	50/122	°C/°F	S	YES
dP1	Maximum defrost duration	45	1	240	min	S	YES
dP2	Max auxiliary evaporator defrost duration	45	1	240	min	S	YES
d6	Display on terminals during defrosts: 0 = temperature alternating with 'dEF'; 1 = freeze display; 2 = 'dEF'.	1	0	2	-	S	YES
dd	Dripping time after defrost (fans off) 0 = no dripping	2	0	15	min	M	NO
d7	Skip defrost: 0 = Disabled - 1 = Enabled	0	0	1	-	M	NO
d8	Bypass high temperature alarm time after defrost	1	1	240	hours	S	SI
d10	Compressor on time for defrost running time mode 0 = function disabled	0	0	240	min	M	NO
d11	Defrost temperature threshold in running time mode	-50/ -58	-50/ -58	50/ 122	°C/°F	M	NO
d15	Start defrost delay	0	0	240	min	M	NO

Code	Description	Def	Min	Max	UOM	User	User terminal
dn	Nominal defrost duration for skip defrost	75	0	100	%	M	NO
dnM	Maximum defrost duration for skip defrost	45	0	240	min	M	NO
F2	Evaporator fans with compressor off: 0 = see F0; 1 = always off	1	0	1	-	M	YES
F3	Evaporator fans during defrosts: 0 = on - 1 = off	1	0	1	-	M	NO
Fd	Post-dripping time after defrost (fans off with control active)	2	0	15	min	M	NO
Fpd	Evaporator fans during post-dripping 0/1 = On/Off	1	0	1	-	M	NO
Fsh	Modulating evaporator fan speed in dehumidification	40	0	100	%	S	NO
A3	Defrost terminated after maximum time signal: 0 = Disabled 1 = Enabled	0	0	0	-	S	YES

Below is the trend of the defrost output based on the setting of parameter d0.

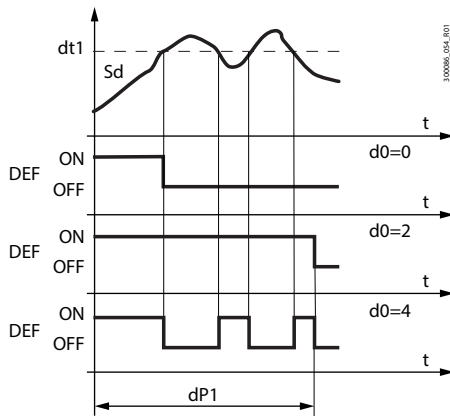

Fig. 6.ad

Ref.	Description
t	time
dt1	End defrost temperature
dP1	Maximum defrost duration
Sd	Defrost probe
DEF	Defrost
d0	Type of defrost

The heater defrost by time with temperature control (d0=4) activates the defrost output only if the evaporator temperature (Sd) is less than the value of parameter dt1, and ends after the time defined by dP1. This function is useful for energy saving and to prevent excessive temperatures on the evaporator.

Parameters td1 to td8 can be used to set up to 8 defrost events based on the controller's clock (RTC), on models where featured. To set parameters td1 to td8, use the supervisor, the configuration tool or the Applica app. See "Configuration tools".

Code	Description	Def.	Min	Max	UOM	User	User terminal
td1..8-d	Defrost 1 to 8 - day 0 event disabled 1 to 7 Monday to Sunday 8 Monday to Friday	9 10 11	Monday to Saturday Saturday & Sunday every day			S	NO
td1..8-hh	Defrost 1 to 8 - hours	0	0	23	hours	S	NO
td1..8-mm	Defrost 1 to 8 - minutes	0	0	59	min	S	NO
td1..8-time	Defrost 1 to 8 - data type for Applica	00:00:00	00:00:00	23:59:59	-	S	NO

Input and output settings

Code	Description	Def.	Min	Max	UOM	User	User terminal
/Fb	Assign defrost temperature probe (Sd) - see /FA	0	0	7	-	M	NO
/cb	Defrost temperature probe (Sd) calibration	0	-20/ -36	20/ 36	Δ °C/°F	S	NO
/FF	Assign auxiliary evaporator defrost temperature probe (Sd2) - see /FA	0	0	7	-	M	NO
/cF	Auxiliary evaporator defrost temperature probe (Sd2) calibration	0	-20/ -36	20/ 36	Δ °C/°F	S	NO
DOG	Assign defrost digital output - see DOA	2 (small) / 6 (large)	0	6	-	M	NO
rOG	Defrost digital output logic - see rOA	0	0	1	-	S	NO
DOH	Assign auxiliary evaporator defrost digital output - see DOA	0	0	6	-	M	NO
rOH	Auxiliary evaporator defrost digital output logic - see rOA	0	0	1	-	S	NO

Start defrost

The events that activate a defrost are shown in the table.

Event	Defrosting
Interval between defrosts expired	Dependent on enabling (dI > 0)
Time band	Dependent on enabling (time bands set) and presence of the RTC
Compressor running time	Dependent on enabling (d10 > 0)
Start-up	Dependent on enabling (Sd < d11)
At each compressor start	Dependent on enabling (Sd < d11)
Digital input	Dependent on enabling (DIId > 0)
Supervision	Always
Keypad/Direct function	Dependent on the presence of the button/enabling of the direct function
App/Commissioning tool	Always
Opening the door	Dependent on enabling (dCL > 0)

Tab. 6.k

Start defrost

The iJF controller can manage the following types of defrosts, based on the setting of parameter d0:

1. heater (placed near the evaporator) by temperature;
2. hot gas by temperature;
3. heater by time;
4. hot gas by time;
5. heater by time with temperature control.

The details of each type of defrost are illustrated in the following paragraphs.

If defrost by temperature is selected, it is performed only if the value read by the evaporation temperature probe Sd is lower than the defrost end value (dt1 and dt2) or has an error. This also applies when there are two evaporators.

For heater defrosts:

- first the time d15 elapses;
- the compressor stops (performing pump down, if enabled);
- the main and secondary evaporator defrost relays are activated to switch on the heaters.

During hot gas defrost:

- first the time d15 elapses;
- then the compressor stops;
- the time dHG/2 elapses;
- the main and secondary evaporator defrost relays are activated to activate the hot gas valve.
- the time dHG/2 elapses;
- the compressor starts;

Notice: if parameter dHG has a value other than zero, pump down is not performed during hot gas defrost.

Notice: if the control temperature is lower than the low temperature alarm threshold (parameter AL or ALA), the compressor cannot start and therefore the hot gas defrost will not be performed. If the temperature falls below the alarm threshold during defrosting, the compressor will stop immediately.

End defrost

The defrost ends by temperature when the values set by parameters dt1 and dt2 are reached, or by time, when the values dP1 and dP2 are reached, based on the setting of parameter d0. If defrost by temperature is selected, the defrost probe Sd needs to be installed; the defrost ends when the probe Sd measures a value greater than the setting of dt1 or by timeout after the maximum time dP1 has elapsed; in this case, based on the setting of parameter A3, Ed1 is displayed.

If set to end by time, the defrost ends after the time dP1.

The heater defrost by time with temperature control (d0=4) activates the defrost output only if the evaporator temperature Sd is less than the value of parameter dt1, and ends after the time defined by dP1. This function is useful for energy saving and to avoid excessively heating the evaporator.

For units with two evaporators, the defrost ends when both evaporators have reached the end defrost condition. If one evaporator ends defrosting (by time or by temperature) before the other, the corresponding defrost relay is de-energised, while the compressor remains in the status required by the defrost.

For hot gas defrost, when the defrost ends:

- the compressor stops;
- the time dHG/2 elapses;
- the main and secondary evaporator defrost relays are deactivated to deactivate the hot gas valve.
- the time dHG/2 elapses;
- the compressor starts;

At the end of the defrost, the controller can activate the dripping phase (if dd>0), during which the compressor and the fans are off, followed by the post-dripping phase (if Fd>0), during which control resumes with the fans off. If the defrost ends prematurely (e.g. interrupted by keypad/BMS), the dripping and post-dripping phases are skipped.

The type of display on the user terminal during defrosting can be selected by setting parameter d6.

Notice: high temperature alarms can be disabled after defrosting by setting par. d8.

6.16.1 Heater defrost (d0 = 0, 2, 4): duty cycle

The duty cycle refers to the default values of parameters F2 and F3.

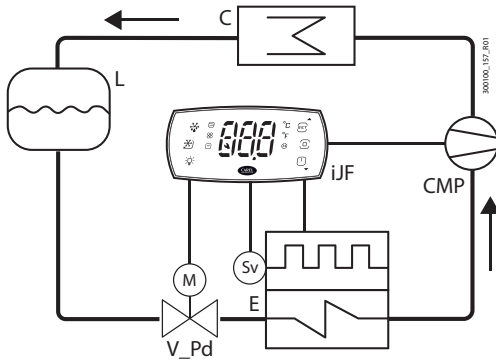

Fig. 6.ae

Ref.	Description
t	Time
FAN	Fan
DEF	Defrost
DRIP	Dripping
CMP	Compressor
POST DRIP	Post-dripping
REFRIG	Control

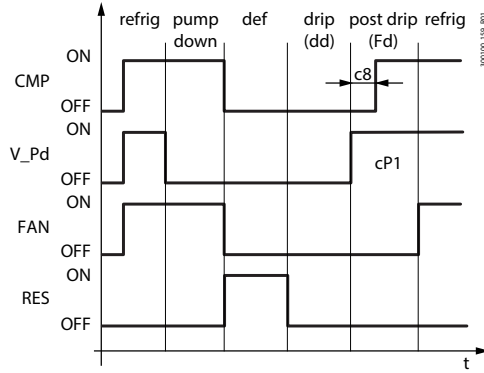

Fig. 6.af

Ref.	Description
RES	Defrost heater
V_Pd	Pump down valve
C	Condenser
E	Evaporator
L	Liquid receiver
HOT GAS	Hot gas valve

6.16.2 Hot gas defrost (d0 = 1, 3): duty cycle

The duty cycle refers to the default values of parameters F2 and F3.

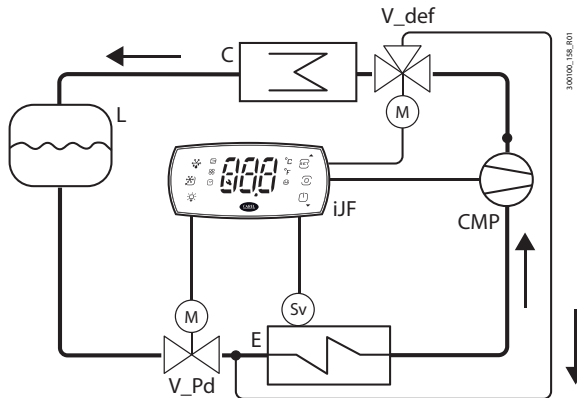

Fig. 6.ag

Ref.	Description
t	Time
FAN	Fan
DEF	Defrost
DRIP	Dripping
CMP	Compressor
POST DRIP	Post-dripping

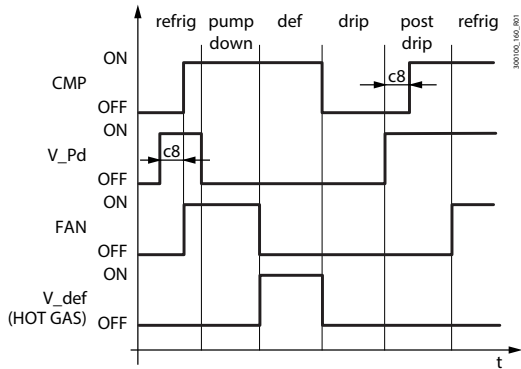

Fig. 6.ah

Ref.	Description
REFRIG	Control
HOT GAS	Hot gas valve
V_Pd	Pump down valve
C	Condenser
E	Evaporator
L	Liquid receiver

Notice: the defrost output (DEF) is used to control the hot gas valve V_def.

Pump down is the period in which the evaporator is emptied of liquid refrigerant, and can be disabled by setting cPt=0 (see "Pump down phase duration"). Operation of the fan during the pump down phase depends on parameters F2 and F3. During the dripping phase the fan is always off, while during the post-dripping phase operation depends on the setting of parameter Fpd.

Code	Description	Def	Min	Max	UOM	User	User terminal
dd	Dripping time after defrost (fans off) 0 = no dripping	2	0	15	min	M	NO
cPt	Pump down phase duration 0 = pump down disabled	0	0	900	s	M	NO
F2	Evaporator fans with compressor off: 0 = see F0; 1 = always off	1	0	1	-	M	NO
F3	Evaporator fans during defrosts: 0 = on - 1 = off	1	0	1	-	M	NO
Fd	Post-dripping time after defrosting (fans off with control active)	2	0	15	min	M	NO

6.16.3 Advanced defrosting features

Maximum interval between consecutive defrosts (par. dl)

Code	Description	Def	Min	Max	UOM	User	User terminal
dl	Maximum interval between consecutive defrosts	8	0	240	hours	S	YES

Tab. 6.l

Parameter dl is a safety parameter used to perform cyclical defrosts every “dl” hours, event without the real time clock (RTC). At the start of each defrost, irrespective of the duration, an interval starts being counted. If this interval exceeds dl without a defrost being performed, one is started automatically. The count is always active even if the controller is OFF.

Example.

If the defrost programmed by time td3 is not carried out due to a fault in the RTC, a new defrost starts after the safety time dl.

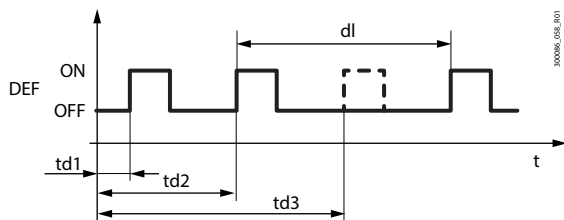

Ref.	Description
dl	Maximum interval between consecutive defrosts
td1...td3	Scheduled defrosts
t	time
DEF	Defrost

Fig. 6.ai



Notice:

- if the interval dl expires when the controller is OFF, a defrost will be performed when it is switched ON;
- to ensure correct defrosting, the interval between defrosts must be greater than the maximum defrost duration, increased by the dripping and post-dripping times.



Notice: to avoid unwanted defrosts controlled by the timer, set parameter dl=0 (defrosts from keypad, RTC, compressor running time or digital input only).

Running time defrost (par. d10, d11)

Running time is a special function that determines when the refrigeration unit needs defrosting. In particular, it is assumed that if the compressor is on for a certain time (d10) and the evaporator temperature measured by probe Sd remains continuously below a certain set threshold (d11), the evaporator may be frozen and a defrost is activated. The time is reset if the temperature returns above the threshold.

Code	Description	Def	Min	Max	UOM	User	User terminal
dt1	End defrost temperature (read by Sd)	4/ 39.2	-50 /-58	50/122	°C/°F	S	YES
dt2	Auxiliary evaporator end defrost temperature (read by Sd2)	4/ 39.2	-50 /-58	50/122	°C/°F	S	YES
d10	Compressor on time for defrost running time mode 0 = function disabled	0	0	240	min	M	NO
d11	Defrost temperature threshold in running time mode	-50 /-58	-50 /-58	50/122	°C/°F	M	NO

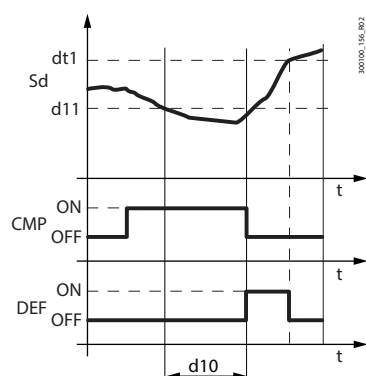

Ref.	Description
Sd	Defrost probe
t	time
DEF	Defrost
CMP	Compressor

Fig. 6.aj

Defrost at each compressor start

With defrosts controlled by temperature, if the evaporator temperature is lower than d11 when there is a cooling request, preventive defrosting is required before starting the compressor. This avoids starting the compressor and then stopping immediately afterwards, thus reducing the number of compressor starts.



Notice: this condition is not verified the first time the compressor is started after switching the unit on.

Defrost after opening the door

Opening the door allows humid air into the showcase, which can condense and freeze on the evaporator. Consequently, the controller records the number of door openings that occur when the evaporation temperature is below zero. When the door is opened a number of times equal to the setting of DoL, a defrost is activated. The controller checks the defrost duration and adjusts the number of door openings that must be reached before the next defrost.

Par.	Description	Def	Min	Max	UOM	User	User terminal
dCH	Defrost after opening the door: maximum number of openings	50	dCL	99	-	M	NO
dCL	Defrost after opening the door: minimum number of openings	0	0	dCH	-	M	NO
dPH	Defrost after opening the door: maximum defrost duration	15	dPL	dP1	min	M	NO
dPL	Defrost after opening the door: minimum defrost duration	5	0	dPH	min	M	NO

If the defrost duration:

- is less than dPL, the number of openings is increased by 10;
- is more than dPH, the number of openings is decreased by 5;
- is between dPL and dPH, the number of openings remains unchanged.

In any case, the number of door openings always remains between the minimum and maximum limits dCL and dCH.

Notice: the door opening counter is reset every time a defrost is performed.

Skip defrost (par. d7, dn)

If defrosts ending by temperature are set, the skip defrost function evaluates whether the defrost duration is less than a certain threshold dn1 (dn2) and based on this establishes whether or not the following defrosts can be skipped.

Code	Description	Def	Min	Max	UOM	User	User terminal
dP1	Maximum defrost duration	45	1	240	min	S	YES
dP2	Max auxiliary evaporator defrost duration	45	1	240	min	S	YES
d7	Skip defrost: 0 = Disabled - 1 = Enabled	0	0	1	-	M	NO
dn	Nominal defrost duration for skip defrost	75	0	100	%	M	NO

Thresholds dn1 (evaporator 1) and dn2 (evaporator 2) are calculated based on the parameter settings:

$$dn1 = \frac{dn}{100} \cdot dP1 \quad dn2 = \frac{dn}{100} \cdot dP2$$

The algorithm keeps a counter of the defrosts to be skipped:

- when switching the controller on, the defrost is performed 7 times without increasing the counter, from the eighth on the counter is updated;
- if the defrost ends in a time less than dn1 (dn2), the counter of the defrosts to be skipped is increased by 1;
- when the counter reaches 1, the next defrost is skipped; if the next defrost ends in a time less than dn1 (dn2), the counter is increased to 2 and 2 defrosts are skipped; if also the next defrost ends in a time less than dn1 (dn2), the counter is increased to 3 and 3 defrosts are skipped, the counter is reset and the algorithm restarts (see table).

Defrost sequence	1	2	3	4	5	6	7	8	9	10	11	12	13	14	15	16	17	18	19	20	21	22
"short defrost"?	-	-	-	-	-	-	-	Y	-	Y	-	-	Y	-	-	-	Y	-	Y	-	-	Y
Counted	-	-	-	-	-	-	-	1	-	2	-	-	3	-	-	-	1	-	2	-	-	3
Defrost Skipped	N	N	N	N	N	N	N	N	Y	N	Y	Y	N	Y	Y	Y	N	Y	N	Y	Y	N

Algorithm restart

Notice: whenever a defrost ends after dn1 (dn2), the next defrost is performed and the counter is reset.

Nota: the algorithm is applied only in case of defrosts programmed by scheduler or cyclic defrosts (par. dl), manual defrosts or defrosts started from the supervisory system are always performed and don't have effects on the counter.

Auxiliary evaporator defrost

Up to two defrost probes and up to two evaporator outputs can be configured, activating a heater on the main evaporator and another on the auxiliary evaporator. The controller recognises the basic configuration shown in the following table.

Defrost outputs	Evaporator probes	Start defrost
1	1	Normal
2	1	Defrosting managed on two outputs with reference to the same evaporator probe
1	2	Defrosting managed on the same output with reference to the two evaporator probes (minimum evaporation temperature)
2	2	Defrosting managed independently on the two evaporator circuits

Tab. 6.m

6.16.4 Other defrost parameters

End defrost signal by timeout (par. A3)

Code	Description	Def	Min	Max	UOM	User	User terminal
A3	End defrost signal by timeout 0 = disabled; 1 = enabled	0	0	1	-	M	NO

Defrost at power on (par. d4)

Code	Description	Def	Min	Max	UOM	User	User terminal
d4	Enable defrost at power on: 0 = Disabled 1 = Enabled	0	0	1	-	M	NO

The defrost request at power on has priority over the control request and activation of the continuous cycle.

Defrost delay at power on (parameter d5)

Code	Description	Def	Min	Max	UOM	User	User terminal
d5	Defrost delay at power on or after command from digital input	0	0	240	min	M	NO

Also active when d4=0. If the digital input is set to enable or start a defrost from an external contact, parameter d5 represents the delay between when the defrost is enabled or requested, and when it effectively starts.

Dripping time after defrost (par. dd)

Code	Description	Def	Min	Max	UOM	User	User terminal
dd	Dripping time after defrost (0 = no dripping)	2	0	15	min	M	NO

This parameter is used to stop the compressor and the evaporator fans following a defrost so as to allow the evaporator to drip. The value of the parameter indicates the off time in minutes. If dd=0 no dripping time is enabled, and at the end of the defrost control resumes immediately, without stopping the compressor and the fan, if active.

Pump down phase duration (par. cPt)

Code	Description	Def	Min	Max	UOM	User	User terminal
cPt	Pump down phase duration 0 = pump down disabled	0	0	999	s	M	NO

The pump down phase is the period in which the evaporator is emptied of liquid refrigerant. Parameter cPt defines the duration of the pump down phase whenever control stops.

Defrost priority over compressor protection (par. d9)

Code	Description	Def	Min	Max	UOM	User	User terminal
d9	Defrost priority over compressor protection times: 0 = the compressor protection times are observed; d9 = 1: the compressor protection times are ignored, therefore defrosting starts without waiting for the compressor protection times to elapse	0	0	1	-	M	NO

Parameter d9 is used to set the priority of defrosts over the compressor times c1, c2, c3 when there is a defrost request.

Defrost priority over continuous cycle (par. c7)

Code	Description	Def	Min	Max	UOM	User	User terminal
c7	Defrost priority over continuous cycle: 0 = continuous cycle has priority; 1 = defrost has priority.	0	0	1	-	M	NO

Parameter c7 is used to set the priority of defrosts over the continuous cycle:

- if c7 = 0, the continuous cycle has priority over the defrost requests;
- if c7 = 1, if the continuous cycle is in progress and there is a defrost request, the continuous cycle ends and the defrost starts.

Defrost interval unit of measure (par. dC)

Code	Description	Def	Min	Max	UOM	User	User terminal
dC	Time base for defrosts 0: dI in hours, dP1 and dP2 in minutes 1: dI in minutes, dP1 and dP2 in seconds	0	0	1	-	S	NO

Parameter dC is used to change the unit of measure (hours/minutes or minutes/seconds) used to count the times for parameters dI (defrost interval, hours or minutes), dP1 and dP2 (defrost duration). This feature is particularly useful when configuring the defrosts.

6.17 Evaporator fans

The evaporator fans can be fixed speed (On/Off) or variable speed (modulating 0-10 V).

Notice: variable speed fans are only available on models with analogue outputs Y1 and Y2, PWM or 0-10 V, see "Introduction".

To assign the On/Off or modulating output, use the parameters shown in the table.

Par.	Description	Def	Min	Max	UOM	User	User terminal
DOI	Assign evaporator fan digital output - see DOA	3 (small)/ 4 (large)	0	6	-	S	NO
rOI	Evaporator fan digital output logic - see rOA	0	0	1	-	S	NO
/AA	Assign analogue output for modulating evaporator fan 0 = not configured; 1 = analogue output 1 (Y1) 2 = analogue output 2 (Y2)	0	0	2	-	S	NO
/P5	Configuration of analogue output Y1: 7 = 0..10V; 8 = PWM	8	7	8	-	S	NO
/P6	Configuration of analogue output Y2: 7 = 0-10 V; 8 = PWM	8	7	8	-	S	NO

Notice: if an analogue output is assigned to the variable-speed evaporator fan function and the evaporator fan is also assigned to a relay output, both outputs will be active at the same time; if the speed is greater than 0, the relay will remain active (closed):

- if speed (Y1) > 0 → "FAN" relay ON (NO* closed)
- if speed (Y1) = 0 → "FAN" relay OFF (NO* open)

6.17.1 Fixed-speed evaporator fans

To activate the algorithm, simply assign a relay output to the evaporator fan function (on some models this is already assigned by default, see the product label). In addition, the defrost probe needs to be configured if this is required for control. See "Inputs and outputs". The parameters used to manage fixed-speed fans are shown below (see the connection diagram).

Par.	Description	Def	Min	Max	UOM	User	User terminal
F0	Evaporator fan management: 0 = always on; 1 = activation based on Sd - Sv; 2 = activation based on Sd; 3 = activation based on Sv.	0	0	3	-	S	NO
F1	Evaporator fan activation threshold (only if F0 = 1, 2, 3)	5/ 41	-50/-58	50/122	°C/°F	S	NO
F2	Evaporator fans with compressor off: 0 = see F0; 1 = always off with compressor off; 2 = on for anti-stratification; 3 = on for humidity control.	1	0	3	-	S	NO
Frd	Fan activation differential (including variable speed)	2/ 3.6	0.1/0.2	20/ 36	°C/°F	S	YES

iJF controller manages the evaporator fans as follows:

- F0 = 0 always on;
- F0 = 1 on/off based on difference between probes Sd and Sv;
- F0 = 2 on/off based on defrost probe Sd;
- F0 = 3 on/off based control probe Sv.

If parameter F0 = 0, the evaporator fans are on when the compressor is on (based on the setting of parameter F2), regardless of the defrost or control temperature.

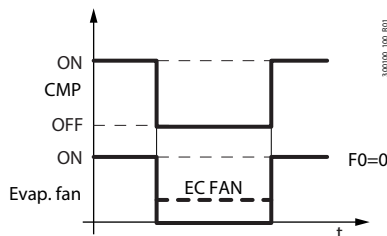
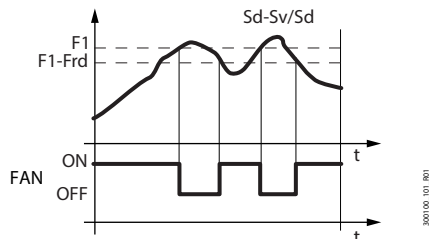

Fig. 6.ak

If parameter F0=1 or 2, the evaporator fans are on/off based on the difference between the defrost and control probe temperatures, or based on the defrost probe reading. The fans switch on when the control variable falls below the threshold F1 value minus the control differential Frd, and switch off when the control variable rises above the threshold F1.

If parameter F0=3, the evaporator fans are on/off based on the control probe reading. The fans switch on when the control variable falls below the threshold St minus the control differential rd, and switch off when the control variable rises above the threshold St.

Fig. 6.al

Ref.	Description
Sd	Defrost probe
Sv	Control probe
F1	Fan activation threshold (St if F0=3)
Frd	Differential (rd if F0=3)
t	time
FAN	Evaporator fans

The fans can be switched off in the following situations:

- when the compressor is off (parameter F2);
- during defrosts (parameter F3).

The evaporator fans can be forced on during control (parameter F2) and during defrosts (parameter F3).

Evaporator fans during defrosts

When defrosting (parameter F3), the fans can be forced off. During the dripping time (parameter dd > 0) the fans are always off, while during the post-dripping time (parameter Fd > 0), the status of the fans can be defined by setting parameter Fpd. This is useful to allow the evaporator to return to temperature after defrosting, thus avoiding blowing warm hot and moist air into the refrigerated environment.

Par.	Description	Def	Min	Max	UOM	User	User terminal
dd	Dripping time after defrost (0 = no dripping)	2	0	15	min	M	NO
F3	Evaporator fans during defrosts: 0 = on; 1 = off.	1	0	1	-	S	NO
Fd	Post-dripping time after defrosting (fans off with control active)	2	0	15	min	M	NO
Fpd	Evaporator fans during post-dripping: 0 = on; 1 = off.	1	0	1	-	M	NO

Anti-stratification

Set parameter F2 = 2 to prevent stratification of the air inside the showcase when the compressor is off. The fan performs a series of ON and OFF cycles with settable times that differ depending on the time (day or night). When the compressor is switched off, the fan remains ON.

Par.	Description	Def	Min	Max	UOM	User	User terminal
F2	Evaporator fans with compressor off: 0 = see F0; 1 = always off with compressor off; 2 = on for anti-stratification; 3 = on for humidity control.	1	0	3	-	S	NO
Fd0	Evaporator fan ON time for anti-stratification during the day	5	1	100	min	M	NO
FdF	Evaporator fan OFF time for anti-stratification during the day (0 = always ON during the day)	10	0	100	min	M	NO
Fn0	Evaporator fan ON time for anti-stratification at night	5	1	100	min	M	NO
FnF	Evaporator fan OFF time for anti-stratification at night (0 = always ON at night)	20	0	100	min	M	NO

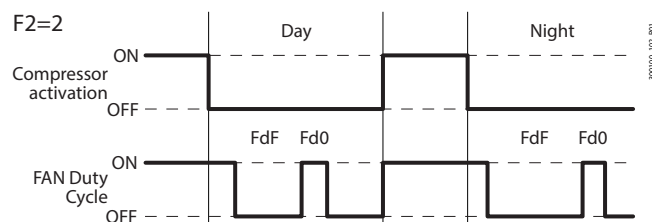
Fig. 6.am

Humidity management with evaporator fan cycles

If F2 = 3, when the compressor is off, the fan is controlled based on the humidity level set by parameter HU, selected between three humidity levels: low, medium and high, which correspond to three different sets of fan on/off times and three different control temperature differentials for compressor activation.

Par.	Description	Def	Min	Max	UOM	User	User terminal
HU	Humidity level: 0: low; 1: medium; 2: high.	1	0	2	-	U	NO
F2	Evaporator fans with compressor off: 0 = see F0; 1 = always off with compressor off; 2 = on for anti-stratification; 3 = on for humidity control.	1	0	3	-	S	NO
F11	Fan ON time with low humidity level	60	0	600	Sec	M	NO
F12	Fan OFF time with low humidity level	120	0	600	Sec	M	NO
F13	Fan ON time with medium humidity level	120	0	600	Sec	M	NO
F14	Fan OFF time with medium humidity level	120	0	600	Sec	M	NO
F15	Fan ON time with high humidity level	180	0	600	Sec	M	NO
F16	Fan OFF time with medium humidity level	120	0	600	Sec	M	NO
F17	Temperature control differential for compressor activation with low humidity level	2.0/ 3.6	0.1/0.2	20/36	°C/°F	M	NO
F18	Temperature control differential for compressor activation with medium humidity level	2.0/ 3.6	0.1/0.2	20/36	°C/°F	M	NO
F19	Temperature control differential for compressor activation with high humidity level	2.0/ 3.6	0.1/0.2	20/36	°C/°F	M	NO

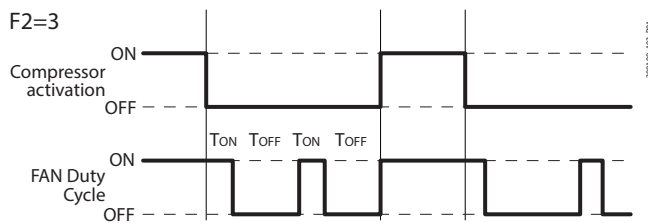

Ref.	Description
TON	F11/F13/F15
TOFF	F12/F14/F16

Fig. 6.an

6.17.2 Variable-speed evaporator fans (EC fans)

Variable-speed fans may be useful for optimising energy consumption. In this case, the fans are powered by the mains, while the control signal may come via output Y1 or Y2 on the iJF controller, set as 0-10 Vdc.

Notice: variable speed fans are only available on models with analogue outputs Y1 and Y2, PWM or 0-10 V, see "Introduction".

To activate the algorithm, simply assign an analogue output to the variable-speed evaporator fan function by setting the type of output accordingly. In addition, the evaporation temperature probe needs to be configured if this is required for control. See "Inputs and outputs".

The maximum and minimum fan speed can be set using parameters F6 and F7 (as a percentage of the range 0-10 V). The fan speed varies proportionally across the range of modulation.

For example, considering the default values of the parameters, if F0 = 2 and $S_d = (F1 - Frd) / 2 = 6^\circ\text{C}$ → output Y1 corresponds to the percentage $(F6 + F7) / 2 = 50\%$. Nel caso si utilizzi il regolatore di velocità per i ventilatori, F5 rappresenta la temperatura sotto la quale si attivano i ventilatori, con un'isteresi fissa di 1°C per lo spegnimento.

Par.	Description	Def	Min	Max	UOM	User	User terminal
F0	Evaporator fan management: 0 = always on; 1 = activation based on $S_d - S_v$; 2 = activation based on S_d ; 3 = activation based on S_v .	0	0	3	-	S	NO
F1	Evaporator fan activation threshold (only if F0=1 or 2)	5/ 41	-50/-58	50/122	°C/°F	S	NO
F5	Evaporator fan cut-off temperature (hyst. 1°C)	50	F1	50	°C/°F	M	NO
F6	Maximum evaporator fan speed	100	F7	100	%	M	NO
F7	Minimum evaporator fan speed	0	0	F6	%	M	NO
F8	Evaporator fan start-up time (0 = function disabled)	0	0	240	s	M	NO
F10	Evaporator fan forcing time at maximum speed (0 = function disabled)	0	0	240	min	M	NO
Frd	Evaporator fan activation differential (including variable speed)	2/ 3.6	0.1/0.2	20/36	°C/°F	S	NO

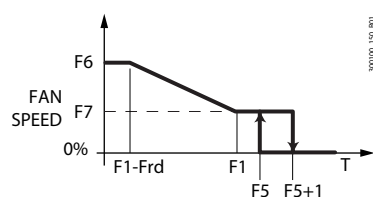

Ref.	Description
T	temperature
F1	Fan activation threshold
Frd	Differential
F5	Fan cut-off temperature
F6	Maximum speed
F7	Minimum speed

Fig. 6.a0

If parameter $F0=0$, the evaporator fans are on when the compressor is on (based on the setting of parameter $F2$), regardless of the defrost or control temperature.

If parameter $F0 = 1$, the evaporator fan speed is modulated based on the evaporator temperature and the control temperature, with the speed increasing the further the temperature is below $Sv-F1$.

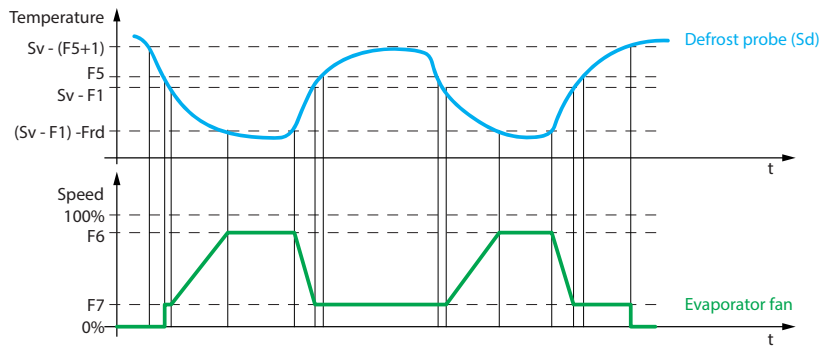

Ref.	Description
Sv	Control probe
F1	Fan activation threshold
Frd	Differential
F5	Fan cut-off temperature
F6	Maximum evaporator fan speed
F7	Minimum evaporator fan speed
t	time
Speed	Evaporator fan speed

Fig. 6.ap

If parameter $F0=2$, the evaporator fan speed is modulated based on the evaporator temperature alone, with the speed increasing the further it falls below $F1$.

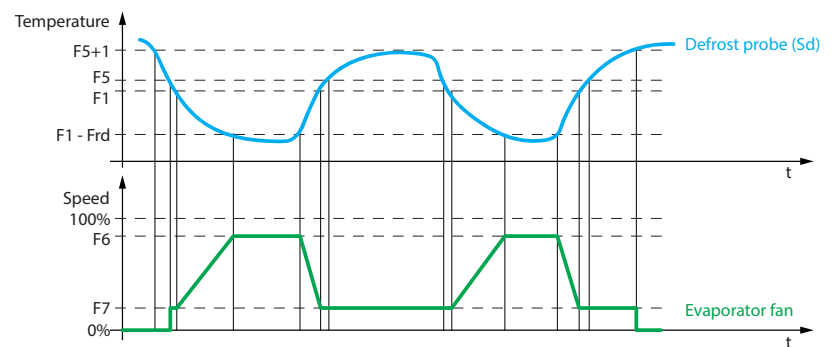

Ref.	Description
Sv	Control probe
F1	Fan activation threshold
Frd	Differential
F5	Fan cut-off temperature
F6	Maximum evaporator fan speed
F7	Minimum evaporator fan speed
t	time
Speed	Evaporator fan speed

Fig. 6.aq

If parameter $F0=3$, the evaporator fan speed is modulated based on the control temperature alone, with the speed increasing the further it rises above the set point.

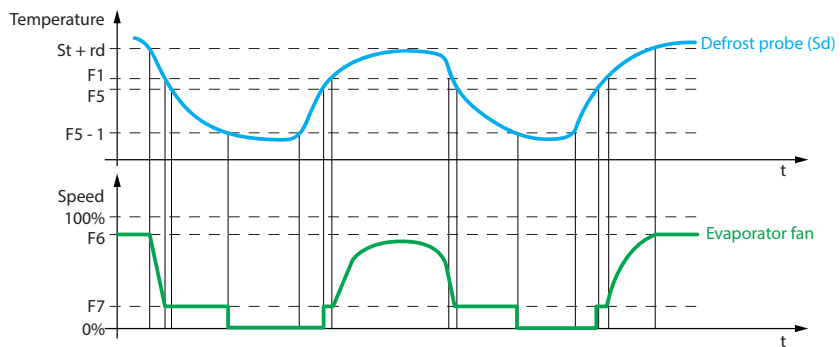

Ref.	Description
Sv	Control probe
F1	Fan activation threshold
Frd	Differential
St	Temperature control set point
rd	Temperature control differential
F5	Fan cut-off temperature
F6	Maximum evaporator fan speed
F7	Minimum evaporator fan speed
t	time
Speed	Evaporator fan speed

Fig. 6.ar

Notice: The behaviour of the variable speed fans can be influenced not only by the “cooling” request and by the temperature, but also by other control functions (dehumidification, humidification and heating), if available.

Notice: if two defrost probes are configured ($Sd1$ and $Sd2$), the fan speed is calculated in relation to the probe that measures the higher temperature (to limit the influx of warm air):

- if $Sd > Sd2 \rightarrow$ control on Sd ;
- if $Sd < Sd2 \rightarrow$ control on $Sd2$.

Advanced evaporator fan parameters

Due to the mechanical inertia of the motor, some EC fans cannot start at the minimum speed set by parameter F7. To solve this problem, the fans can start at the maximum speed set by parameter F6 for a “start-up time”, defined by parameter F8, regardless of the defrost temperature Sd. Vice-versa, if the fan operates too long at low speed, ice may form on the blades; to avoid this, at intervals of every F10 minutes, the fan is switched on at maximum speed for the time set for parameter F8.

Code	Description	Def	Min	Max	UOM	User	User terminal
F6	Maximum evaporator fan speed	100	F7	100	%	M	NO
F7	Minimum evaporator fan speed	0	0	F6	%	M	NO
F8	Evaporator fan start-up time 0 = Function disabled	0	0	240	s	M	NO
F10	Evaporator fan forcing time at maximum speed 0 = Function disabled	0	0	240	min	M	NO

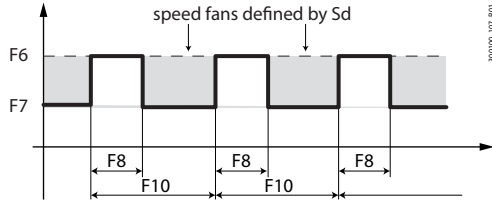

Fig. 6.as

Variable-speed evaporator fans with humidity control

When the humidity control function is active, the fans will operate at maximum between the fixed speed set by parameter F7h and the speed calculated by the controller, for the entire duration of the process.

Par.	Description	Def	Min	Max	UOM	User	User terminal
F7h	Minimum evaporator fan speed during humidification	10	0	100	%	M	NO

If F2 = 3, when the compressor is off, the fan is controlled based on the humidity level set by parameter HU, selected between three humidity levels: low, medium and high, which correspond to three different fan speeds.

Par.	Description	Def	Min	Max	UOM	User	User terminal
F2	Evaporator fans with compressor off: 0 = see F0; 1 = always off with compressor off; 2 = on for anti-stratification; 3 = on for humidity control.	1	0	3	-	S	NO
F20	Modulating evaporator fan speed with low humidity level	10	0	100	%	M	NO
F21	Modulating evaporator fan speed with medium humidity level	10	0	100	%	M	NO
F22	Modulating evaporator fan speed with high humidity level	10	0	100	%	M	NO
HU	Humidity level: 0 = low; 1 = medium; 2 = high	1	0	2	-	U	NO

During the dehumidification phase, when the compressor is off, the fan operates at the speed set for FSh.

Par.	Description	Def	Min	Max	UOM	User	User terminal
FSh	Modulating evaporator fan speed in dehumidification	40	0	100	%	M	NO

6.18 Condenser fans

The condenser fans can be fixed speed (On/Off) or variable speed (modulating 0-10 V).

Notice: variable speed fans are only available on models with analogue outputs Y1 and Y2, PWM or 0-10 V, see “Introduction”.

To assign the On/Off or modulating output, use the parameters shown in the table.

Par.	Description	Def	Min	Max	UOM	User	User terminal
DOt	Assign condenser fan digital output - see DOA	0	0	6	-	M	NO
ROt	Condenser fan digital output logic - see rOA	0	0	1	-	M	NO
/AE	Assign analogue output for modulating condenser fan - see /AA	0	0	2	-	M	NO
/P5	Configuration of analogue output Y1: 7 = 0-10 V; 8 = PWM	8	7	8	-	M	NO
/P6	Configuration of analogue output Y1: 7 = 0-10 V; 8 = PWM	8	7	8	-	M	NO

Notice: if an analogue output is assigned to the variable-speed condenser fan function and the condenser fan is also assigned to a relay output, both outputs will be active at the same time; if the speed is greater than 0, the relay will remain active (closed):

- if speed (Y2) > 0 → “FAN” relay ON (NO* closed)
- if speed (Y2) = 0 → “FAN” relay OFF (NO* open)

6.18.1 Fixed-speed condenser fans

To activate the algorithm, simply assign a relay output to the condenser fan function. The condensing temperature probe also needs to be configured if required for control. See "Inputs and outputs".

The parameters used to manage fixed-speed fans are shown below (see the connection diagram).

Par.	Description	Def	Min	Max	UOM	User	User terminal
F00	Condenser fan management: 0 = always on with compressor on 1 = activation based on Sc, off with compressor off.	0	0	3	-	S	NO
F4	Condenser fan deactivation temperature	40/104	-50/-58	200/392	°C/°F	S	NO
F5d	Condenser fan activation differential	5/9	0.1/0.2	60/108	°C/°F	S	NO

iJF manages the condenser fans as follows:

- F00 = 0 on when the compressor is on;
- F00 = 1 on/off based on the condensing temperature probe Sc; off with the compressor off.

If parameter F00 = 0, the condenser fans are on when the compressor is on, regardless of the condensing temperature.

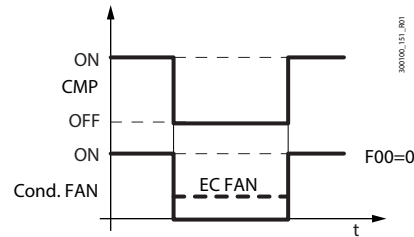

Fig. 6.at

If parameter F00 = 1, the condenser fans are on/off based on the condensing temperature. When the compressor is first started, the condenser fan will start at $F4+0.2^{\circ}\text{C}$ (3.6°F) degrees to compensate for rapid increases in temperature that the probe reading cannot react to. Subsequently, the fan switches on and off at $F4 + F5d$ and $F4$.

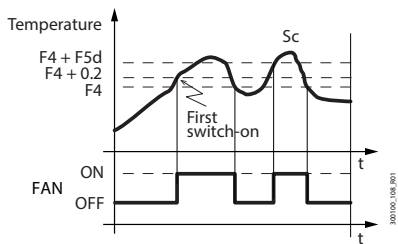

Fig. 6.au

Ref.	Description
Sc	Condensing temperature probe
F4	Fan deactivation threshold
F5d	Differential
t	time
FAN	Condenser fans

6.18.2 Variable-speed condenser fans (EC fans)

Variable-speed fans may be useful for optimising energy consumption. In this case, the fans are powered by the mains, while the control signal may come via output Y1 or Y2 on the iJF controller, set as 0-10 Vdc.

Notice: variable speed fans are only available on models with analogue outputs Y1 and Y2, PWM or 0-10 V, see "Introduction".

To activate the algorithm, simply assign an analogue output to the variable-speed condenser fan function by setting the type of output accordingly. The condensing temperature probe also needs to be configured. See "Inputs and outputs".

The maximum and minimum fan speed can be set using parameters FCH and FCL (as a percentage of the range 0-10 V). The fan speed varies proportionally across the range of modulation. For example, if $Sc=F4-F5d/2$ → output Y2 corresponds to the percentage $(FCH + FCL)/2$.

If using the fan speed controller, F4 represents the temperature below which the fans are activated, with a deactivation hysteresis equal to FCC.

Par.	Description	Def	Min	Max	UOM	User	User terminal
FCC	Modulating condenser fan cut-off temperature	2/3.6	0	50/90	°C/°F	M	NO
FCL	Minimum modulating condenser fan speed	0	0	100	%	M	NO
FCH	Maximum modulating condenser fan speed	100	0	100	%	M	NO

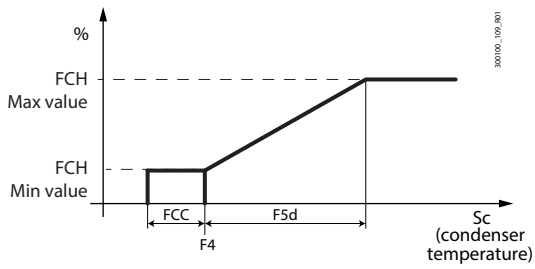

Ref.	Description
Sc	Condenser probe
F4	Fan deactivation threshold
F5d	Differential
FCC	Fan cut-off temperature
FCH	Maximum speed
FCL	Minimum speed

Fig. 6.av

6.19 Humidity management

iJF can manage humidity with or without a humidity probe.

If a probe is available, iJF can interact with external systems by managing the humidity level in combination with cooling control.

iJF is compatible with the CAREL humiSonic, MC Multizone and humiDisk humidification systems.

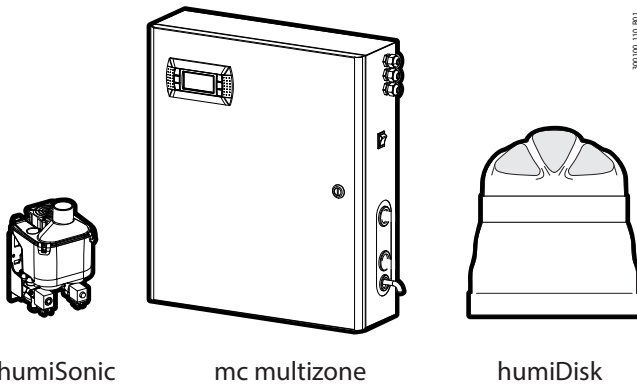

Fig. 6.aw

6.19.1 Humidity control without probe

If no humidity probe is available, humidity control can be performed in three levels, through evaporator fan duty cycles and changing the control temperature differential. See "Humidity management with evaporator fan cycles".

6.19.2 Humidity control with probe

Notice: the humidity probe is only available on models with an option that includes the 0-5 V analogue input, see "Introduction".

Par.	Description	Def	Min	Max	UOM	User	User terminal
/FP	Assign humidity probe (fixed on S5)	5	5	5	-	M	NO
/cP	Humidity probe calibration	0	-20	20	% rH	M	NO

The probe reading can be shown on the display by setting parameter /t1 or can be read under item SHu in the direct functions menu. Furthermore, parameter /ta can be used to alternate the display of the temperature/humidity values.

6.19.3 Humidification output settings

To activate the humidifier, a relay needs to be assigned to the "humidifier" function.

Par.	Description	Def	Min	Max	UOM	User	User terminal
DOu	Assign humidification digital output - see DOA	0	0	6	-	M	NO
rOu	Humidification digital output logic - see rOA	0	0	1	-	M	NO

6.19.4 Dehumidification output settings

To activate an external dehumidifier, a relay needs to be assigned to the “external dehumidifier” function, and in this case its logic will be completely uncoupled from the compressor logic.

Par.	Description	Def	Min	Max	UOM	User	User terminal
DOz	Assign external dehumidifier digital output - see DOA	0	0	6	-	M	NO
rOz	External dehumidifier digital output logic - see rOA	0	0	1	-	M	NO

As well as by an external dehumidifier, dehumidification can also be controlled through simultaneous action of the compressor and a heater; in this case, a relay needs to be assigned to the “heating for dehumidification” function.

To activate dehumidification, simultaneous cooling (compressor) and heating (heater resistance) are required. The effect of cooling is to lower the air relative humidity, while the heater then offsets the excessive cooling, so as to maintain a virtually constant temperature during the process.

Par.	Description	Def	Min	Max	UOM	User	User terminal
DOj	Assign dehumidification digital output - see DOA	0	0	6	-	M	NO
rOj	Dehumidification digital output logic - see rOA	0	0	1	-	M	NO

6.19.5 Humidity control

Humidification

The control logic for humidity control with probe is shown in the figure. When the humidity falls below the humidity set point Sth plus the humidity differential rdh, the humidification output is activated.

Par.	Description	Def	Min	Max	UOM	User	User terminal
Sth	Humidity control set point	90	0.0	100.0	% rH	U	YES
rdh	Humidity control differential	5	0.1	99.9	% rH	S	YES
F4r	Humidification output during defrosts: 0 = active based on humidity control; 1 = deactivated during defrosts	0	0	1	-	M	YES

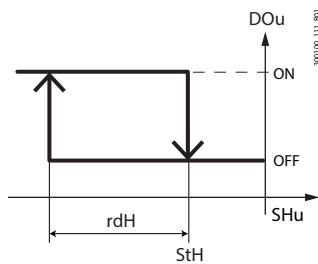

Ref.	Description
SHu	Humidity control probe
Sth	Humidity control set point
rdh	Humidity control differential
DOU	Humidification outlet

Fig. 6.ax

Notice: parameter F4r is used to decide whether or not to disable the humidification output during defrosts:

- F4r=0 -> humidification output active based on humidity control;
- F4r=1 -> humidification output disabled during defrosts, regardless of the request.

Notice: the humidification output is always deactivated in the event of an alarm that stops the compressor immediately.

Examples:

- Alarm CHT;
- Alarm IA (when A6 = 0).

Dehumidification

For humidity control with probe, the dehumidification function can also be managed. The control logic is shown in the figure. When the humidity rises above the humidity set point Sth plus the humidity differential rdh, the dehumidification output is activated.

Par.	Description	Def	Min	Max	UOM	User	User terminal
Sth	Humidity control set point	90	0.0	100.0	% rH	U	YES
rdh	Humidity control differential	5	0.1	99.9	% rH	S	YES

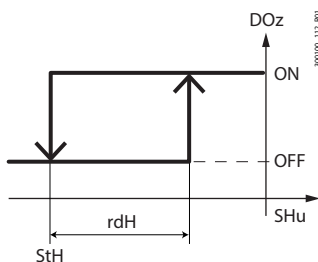

Ref.	Description
SHu	Humidity control probe
Sth	Humidity control set point
rdh	Humidity control differential
DOz	Dehumidification output

Fig. 6.ay

Dead band

Humidity control in the dead band can be enabled by setting both the humidifier and dehumidifier outputs.

Par.	Description	Def	Min	Max	UOM	User	User terminal
Sth	Humidity control set point	90	0.0	100.0	% rH	U	YES
rdh	Humidity control differential	5	0.1	99.9	% rH	S	YES
rrH	Dehumidification differential	5	0	50.0	Δ % rH	S	NO
rnH	Dead band for humidity control	5	0	50.0	Δ % rH	S	NO

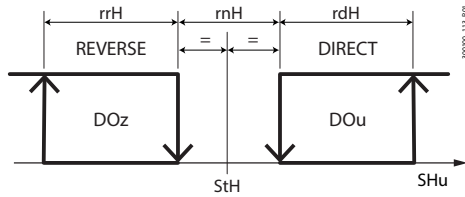

Ref.	Description
SHu	Humidity control probe
Sth	Humidity control set point
rdh	Humidity control differential
rrH	Control differential for dehumidification
rnH	Humidity dead band
DOu	Humidification outlet
DOz	Dehumidification output

Fig. 6.az



Notice: parameter F4r is used to decide whether or not to disable the humidification output during defrosts:

- F4r=0 -> humidification output active based on humidity control;
- F4r=1 -> humidification output disabled during defrosts, regardless of the request.

6.19.6 Simultaneous humidity and temperature control

With simultaneous humidity and temperature control, humidity control is generally independent of temperature control. Humidity control can be restricted to within a well-defined temperature range (parameters TLL and THL and the corresponding differential TdL), so as not to risk excessive temperature drift during humidity control.

Par.	Description	Def	Min	Max	UOM	User	User terminal
TLL	Minimum temperature to enable humidity control	0	-60/-76	60/140	°C/°F	S	NO
THL	Maximum temperature to enable humidity control	0	-60/-76	60/140	°C/°F	M	NO
TdL	Differential to enable humidity control	0	0	20/36	°C/°F	M	NO



Notice: if parameters TLL and/or THL are set to 0, they are ignored for control purposes

Case 1: Humidity control independent of temperature (default)

independent of temperature (default)

The temperature is only controlled after the humidity reaches the set point. This is the default setting, with TLL and THL = 0

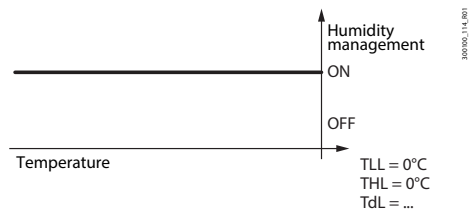

Fig. 6.ba

Case 2: Humidity control within a set range

within a set range

Priority is given to temperature control: humidity is controlled in a series of cycles, while always keeping the temperature in the range TLL-THL.

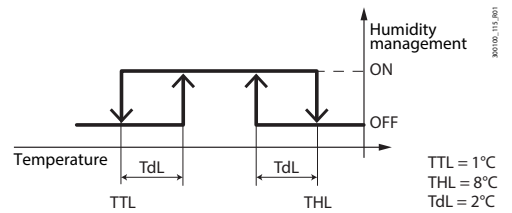

Fig. 6.bb

Case 3: Humidity control with high temperature limit

This configuration prevents the temperature from exceeding the limit (THL) during dehumidification, for example if the heater is oversized.

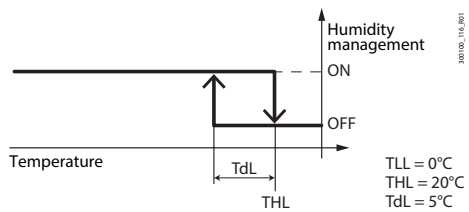

Fig. 6.bc

Case 4: Humidity control with low temperature limit

This configuration allows humidification to be stopped below the threshold TLL threshold to avoid excessive cooling and lowering the temperature, for example if the heater is undersized.

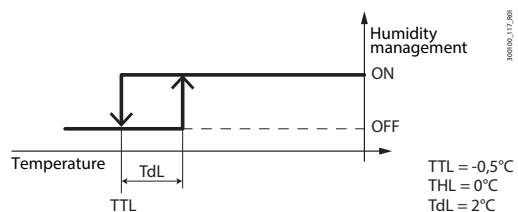

Fig. 6.bd

6.19.7 Humidity probe error

In the event of a humidity probe error, humidification and dehumidification are managed in duty cycles. This is only possible for humidification alone and dehumidification alone; with dead band control, both outputs remain off.

Par.	Description	Def	Min	Max	UOM	User	User terminal
uof	OFF time for humidity duty setting operation	60	c2	120	min	M	NO
uon	ON time for humidity duty setting operation	10	c3	120	min	M	NO

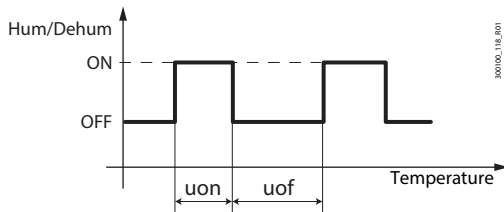

Fig. 6.be

Ref	Description
Hum	Humidification outlet
Dehum	Dehumidification output

6.20 Light management

The light can be controlled by several sources: button, supervisor, door switch, curtain switch and time band. The light is switched on or off based on an event:

Light	Action
Button	Pressing the button
Supervisor	Variation of the value from the supervisor (parameter Lht)
Door switch	Contact transition (opening/closing)
Curtain switch	Contact transition (opening/closing)
Time band	based on the on/off day, hours, minutes

Tab. 6.n

When the digital inputs are stable (door switch or curtain switch), the light can be switched on and off from the keypad or supervisor.

Par.	Description	Def	Min	Max	UOM	User	User terminal
DOE	Assign light digital output - see DOA	4 (small) / 3 (large)	0	6	-	S	NO
rOE	Light digital output logic - see rOA	0	0	1	-	S	NO
/AF	Assign analogue output for modulating lights - see /AA	0	0	2	-	S	NO
HL	Modulating light output activation percentage: 0 = 0%; 1 = 25%; 2 = 50%; 3 = 75%; 4 = 100%	2	0	4	-	U	NO

By setting the analogue output as a light (on part numbers where available), the output can be modulated with four intensity levels, using parameter HL (0, 25, 50, 75 and 100%).

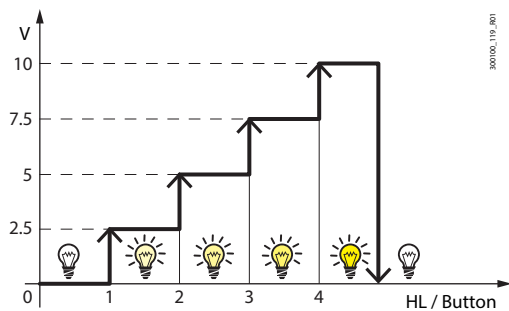

Fig. 6.bf

6.21 Door management

iJF can manage the opening of the door with or without stopping temperature control, based on the setting of the door switch.

Par.	Description	Def	Min	Max	UOM	User	User terminal
DIE	Assign door switch with compressor OFF digital input - see DIA	0	0	4	-	M	NO
DIP	Assign door switch without compressor OFF digital input - see DIA	0	0	4	-	S	NO
rIE	Door switch with compressor OFF digital input logic - see rIA	0	0	1	-	M	NO
rIP	Door switch without compressor OFF digital input logic - see rIA	0	0	1	-	S	NO

If the digital input is configured as a door switch with compressor off (parameter DIE), when the door is opened both the compressor and the evaporator fans are stopped; on the other hand, if configured as a door switch without compressor off (parameter DIP), when the door is opened only the evaporator fans are stopped.

Par.	Description	Def	Min	Max	UOM	User	User terminal
H14	Time light stays on after closing the door	0	0	240	min	U	NO
Ad	Delay time for high and low temp. alarms (AH, AL)	120	0	240	min	U	YES
Add	High temp. alarm bypass time for door open	5	1	240	min	U	YES

When the door is open, the high temperature alarm is ignored for the time set using parameter Add, to avoid false alarms, and the service icon flashes to signal a warning condition. When time Add has elapsed, the following occur:

- the open door alarm (dor) is signalled;
- compressor and evaporator fan control resumes;
- the light stays on;
- after the delay time set by parameter Ad, the high temperature alarm is activated.

When closing the door:

- control resumes, restarting the compressor and evaporator fans if required;
- the light switches off after the time set by parameter H14 and the high temperature alarm is activated after the delay Ad.

When control resumes, the compressor safety times c1 and c2 are observed.

6.22 Door - light interactions

In the absence of time bands, opening the door always activates normal operating mode, which lasts until a different mode is selected via keypad or BMS. The light switches on when the door is opened and switches off when it closes, with a delay equal to H14, if set.

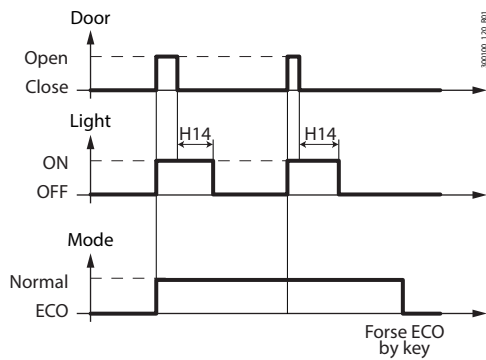

Fig. 6.bg

If time bands are set to define eco/normal mode, the light will follow these rules by switching on in normal mode and off in eco mode. Opening the door will switch back to normal mode and switch on the light.

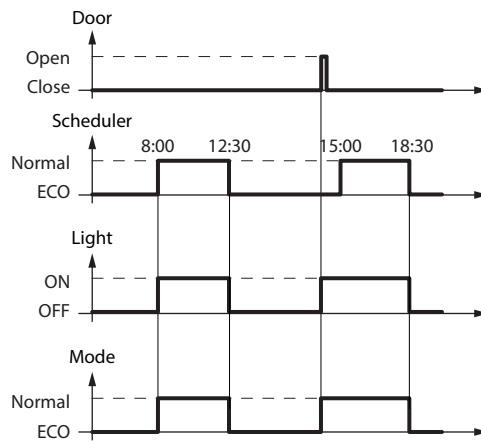

Fig. 6.bh

Par.	Description	Def	Min	Max	UOM	User	User terminal
H8	Output switched with time bands 0 = Light; 1 = AUX	0	0	1	-	S	NO

The time bands can be associated with the AUX output rather than the light, by setting parameter H8. In this case, the light will reflect the position of the door, switching on and off respectively when the door is opened and closed.

6.23 Curtain management

Par.	Description	Def	Min	Max	UOM	User	User terminal
DIG	Assign curtain switch digital input - see DIA	0	0	4	-	S	NO
rIG	Curtain switch digital input logic - see rIA	0	0	1	-	S	NO

If the digital input is associated with the curtain switch, when the curtain is closed the iJF controller activates eco mode and the set point is modified by adding the value of parameter r4. When the curtain is open, the light is always switched on.

Notice: in eco mode, the value $St+r4$ is used for all of the functions that involve the set point (e.g. relative high and low temperature alarms, control with dead band, two-stage compressor control, etc.).

6.24 Generic functions

iJF can exploit unused inputs and outputs to configure a “generic function”. Each generic function can be enabled/disabled in the Applica app or Spark program.

⚠ Caution: the generic functions available vary according to the model of controller.

The following can be activated (maximum configuration):

- 1 generic function with On/Off output;
- 1 generic function with modulating output (only for models where this is available);
- 1 generic alarm function (signal only).

The generic function can be controlled based on one of the following:

- 1 specific probe;
- difference between 2 suitably configured probes.

⚠ Caution: the controller cannot verify the consistency of the settings, if two analogue functions are mistakenly assigned to the same analogue inputs or the same digital output.

6.24.1 Enabling

The generic function can be enabled always, or when the unit is in a certain status.

Par.	Description	Def	Min	Max	UOM	User	User terminal
GFA_E	Generic alarm function: enable	0	0	10	-	M	NO
	0 Always	6					Duty setting
	1 Unit ON	7					Standby
	2 Unit OFF	8					Compressor or reverse output active
	3 Defrost	9					Door open
	4 Not used	10					Alarm active
	5 Continuous cycle						
GFM_E	Generic modulating function: enable - see GFA_E	0	0	10	-	M	NO
GFS_E	Generic On/Off function: enable - see GFA_E	0	0	10	-	M	NO

Assign control probe

Select the control probes for the generic function.

Par.	Description	Def	Min	Max	UOM	User	User terminal
GFA_1	Generic alarm function: control probe 1	0	0	20	-	M	NO
	0 Not configured	11					Glass temperature
	1 Outlet temperature (Sm)	12					Not used
	2 Defrost temperature (Sd)	13					Condensing temperature
	3 Intake temperature (Sr)	14					Humidity
	4 Not used	15					Frost protection temperature
	5 Not used	16					Product temperature
	6 Auxiliary evaporator defrost temperature (Sd2)	17					Not used
	7 Auxiliary probe 1	18					Power present
	8 Auxiliary probe 2	19					Evaporator fan request
	9 Ambient temperature	20					Control probe
	10 Not used						
GFA_2	Generic alarm function: control probe 2 - see GFA_1	0	0	20	-	M	NO
GFM_1	Generic modulating function: control probe 1 - see GFA_1	0	0	20	-	M	NO
GFM_2	Generic modulating function: control probe 2 - see GFA_1	0	0	20	-	M	NO
GFA_1	Generic On/Off function: control probe 1 - see GFA_1	0	0	20	-	M	NO
GFS_2	Generic On/Off function: control probe 2 - see GFA_1	0	0	20	-	M	NO

6.24.2 On/Off output

Assign the digital output for the generic function, the type (direct/reverse) and the activation logic (see parameter rOA).

Par.	Description	Def	Min	Max	UOM	User	User terminal
DOS	Assign generic On/Off function digital output - see DOA	0	0	6	-	S	NO
rOS	Generic On/Off function digital output logic - see rOA	0	0	1	-	S	NO
GFS_D	Generic On/Off function: differential	0	0	99.9	-	S	NO
GFS_S	Generic On/Off function: set point	0	-99	999	-	M	NO
GFS_T	Generic On/Off function: type 0= Direct; 1= Reverse	0	0	1	-	M	NO

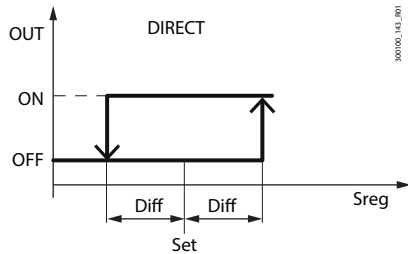

Fig. 6.bi

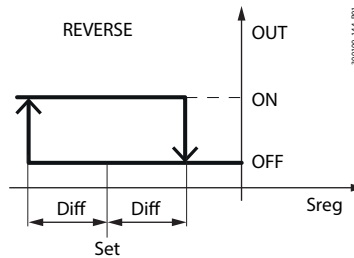

Fig. 6.bj

Ref.	Description
Set	Set point (GFS_S)
Diff	Differential (GFS_D)
Sreg	Control probe 1 or Control probe1 - Control probe 2
OUT	Digital output

6.24.3 Modulating output

Notice: the generic function with modulating output is only available on models with analogue outputs Y1 and Y2, PWM or 0-10 V, see "Introduction".

Assign the modulating output for the generic function and the type (direct/reverse). It is possible to use proportional control only or PID, as well as a cut-off differential with hysteresis.

Par.	Description	Def	Min	Max	UOM	User	User terminal
/Ad	Assign analogue output for generic modulating function - see /AA	0	0	2	-	S	NO
/P5	Configuration of analogue output Y1: 7 = 0-10 V; 8 = PWM	8	7	8	-	S	NO
/P6	Configuration of analogue output Y2: 7 = 0-10 V; 8 = PWM	8	7	8	-	S	NO
GFM_CD	Generic modulating function: cut-off differential	0	0	20	-	S	NO
GFM_D	Generic modulating function: differential	0	0	99.9	-	S	NO
GFM_H	Generic modulating function: hysteresis	0.1	0.1	20	-	M	NO
GFM_Kp	Generic modulating function: proportional gain	0	0	100	-	M	NO
GFM_Max	Generic modulating function: max output value	0	0	100	%	M	NO
GFM_Min	Generic modulating function: min output value	0	0	100	%	M	NO
GFM_S	Generic modulating function: set point	0	-99	999	-	S	NO
GFM_T	Generic modulating function: type 0=direct; 1=reverse	0	0	1	-	M	NO
GFM_Td	Generic modulating function: derivative time	0	0	100	s	S	NO
GFM_Ti	Generic modulating function: integral time	0	0	900	s	S	NO

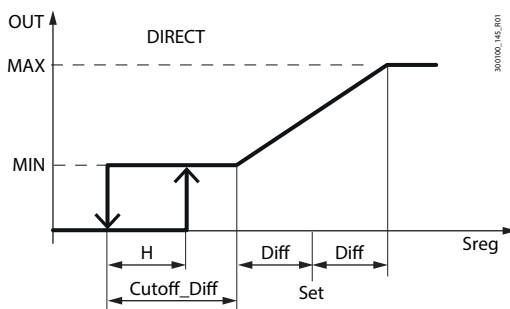

Fig. 6.bk

Ref.	Description
Set	Set point (GFM_S)
Diff	Differential (GFM_D)
H	Hysteresis (GFM_H)
Sreg	Control probe 1 or Control probe1 - Control probe 2
OUT	Digital output
CutOff_Diff	Cut-off differential (GFM_CD)

6.24.4 Alarm signal

The alarm can be signalled for two reasons:

1. switching of the digital input, assigned by parameter DIS: the display shows "GHI"
2. if the difference between the values of the control probes exceeds the high or low threshold for a time longer than GFA_De: the display shows GHI or GLO respectively.

Notice: check that the alarm is generated by only one of the two causes.

Par.	Description	Def	Min	Max	UOM	User	User terminal
GFA_D	Generic alarm function: differential	0	0	99.9	-	S	NO
GFA_De	General alarm function: delay	0	0	30000	s	S	NO
GFA_Ht	Generic alarm function: high temperature threshold	0	GFA_Lth	999	-	S	NO
GFA_Lth	General alarm function: low temperature threshold	0	-99	GFA_Ht	-	S	NO

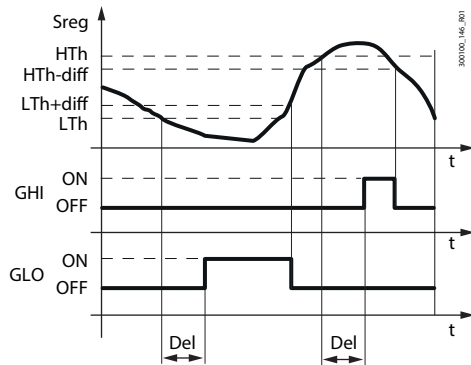

Ref.	Description
Lth	Low temperature threshold (GFA_Lth)
HTh	High temperature threshold (GFA_Hth)
diff	Differential (GFA_D)
Del	Delay (GFA_De)
Sreg	Control probe 1 or Control probe1 - Control probe 2
t	Time
GHI	High temperature alarm message
GLO	Low temperature alarm message

Fig. 6.bl

6.25 Anti-sweat heater or fan

The anti-sweat function in iJF has fixed activation (not based on a glass temperature probe reading) and can control a heater or fan, with the purpose of demisting the showcase glass using the activation and deactivation times set for parameters rHU and rHt.

Par.	Description	Def	Min	Max	UOM	User	User terminal
DOQ	Assign anti-sweat heater digital output - see DOA	0	0	6	-	S	NO
rOq	Anti-sweat heater digital output logic - see rOA	0	0	1	-	S	NO
/Ac	Assign analogue output for modulating anti-sweat heaters - see /AA	0	0	2	-	S	NO
rHt	Manual anti-sweat heater activation period (0 = function disabled)	5	0	180	min	M	NO
rHU	Percentage of manual anti-sweat heater activation in period rHt (0 = function disabled)	70	0	100	%	M	NO

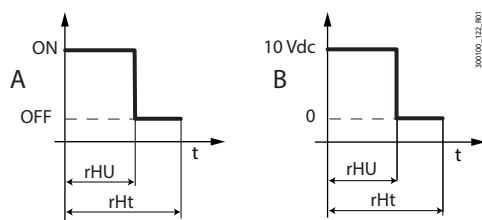

Ref.	Description
A	Relay output
B	Modulating output (0-10V)
rHU	Anti-sweat heater/fan activation percentage
rHt	Anti-sweat heater/fan activation time
t	time

Fig. 6.bm

If either or both of the parameters rHu or rHt is set to zero, the function is disabled.

6.26 Gasket heater

The function activates gasket heating cycles to make it easier to open the door when the control temperature is very low.

Par.	Description	Def	Min	Max	UOM	User	User terminal
DOx	Assign gasket heater digital output - see DOA	0	0	6	-	S	NO
rOx	Gasket heater digital output logic - see rOA	0	0	1	-	S	NO
Oft	Gasket heater OFF time	3	0	250	min	M	NO
OnT	Gasket heater ON time	5	0	250	min	M	NO
Rdrh	Gasket heater control differential	2 / 3.6	0.1 / 0.2	20 / 36	Δ °C/°F	M	NO
Strh	Gasket heater control set point	-18 / -0.4	-50 / -58	200 / 392	°C/°F	S	NO

When the control temperature reaches the set point Strh, the output is enabled and will start being activated cyclically based on the times set for parameters OnT and OfT.

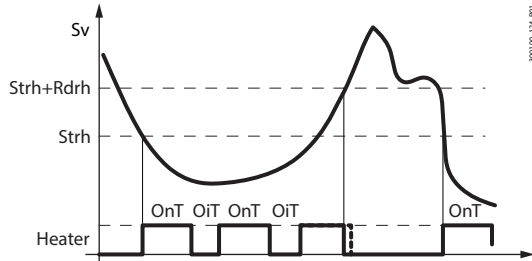

Fig. 6.bn

The output is deactivated when the temperature rises above Strh+Rdrh.

6.27 Drain heater

This function heats the water drained during defrosting to prevent the drain line from freezing.

Par.	Description	Def	Min	Max	UOM	User	User terminal
DOP	Assign drain heater digital output - see DOA	0	0	6	-	S	NO
rOP	Drain heater digital output logic - see rOA	0	0	1	-	S	NO
dHA	Drain heater activation time before defrosting	3	1	120	min	M	NO
dHE	Drain heater activation time after defrosting	3	1	120	min	M	NO

If drain heating is configured, the output is activated for the time set by parameter dHA before defrosting, and remains active for a time set by parameter dHE after defrosting.

6.27.1 Anti-heating

This function keeps the light and AUX outputs deactivated until the control temperature falls below St+Hdh when the following conditions occur:

- controller powered on;
- switching from Off to On;
- after resetting alarms HI, IA, dA, CHt, rE.

Par.	Description	Def	Min	Max	UOM	User	User terminal
Hdh	Delta for anti-heating function	0	0	200/360	Δ °C/°F	M	NO
St	Temperature control set point	50/122	r1	r2	°C/°F	U	YES

6.28 Temperature monitoring

The iJF controller can record the minimum value rL and maximum value rH read by one of the probes, selected by setting parameter r5c, across a time interval rt spanning from the last reset by parameter rL to the present. The monitoring session can be reset at any time, after which the new maximum and minimum values are logged. Monitoring is active when parameter rM is set to 1.

Par.	Description	Def	Min	Max	UOM	User	User terminal
rM	Enable temperature monitoring: 0 = disabled; 1 = enabled	0	0	1	-	S	NO
r5c	Select probe to monitor	3	0	16	-	M	NO
	0 not configured		8 auxiliary probe 2				
	1 outlet temperature (Sm)		9 ambient temperature				
	2 defrost temperature (Sd)		10 not used				
	3 intake temperature (Sr)		11 glass temperature				
	4 not used		12 not used				
	5 not used		13 condensing temperature				
	6 auxiliary evaporator		14 humidity				
	defrost temperature (Sd2)		15 frost protection temperature				
	7 auxiliary probe 1		16 product temperature				
rL	Reset monitoring period	0	0	1	-	U	NO

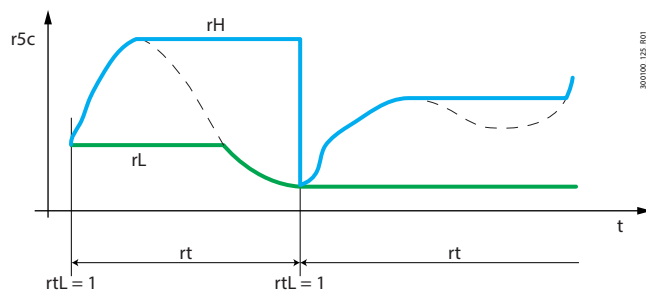

Ref.	Description
rL	reset, restart monitoring
rL	minimum temperature value in the monitored period
rH	maximum temperature value in the monitored period
rt	Monitoring period
r5c	Variable monitored
t	time

Fig. 6.bo

Notice: temperature monitoring can only be activated on models fitted with RTC and with the clock set correctly.

6.29 High and low voltage protection (HLVP)

Some iJF models feature protection against high and low power supply voltages, allowing the compressor to operate only at voltages within the operating limits. This function stops the compressor if the mains voltage is outside of a range specified by parameters uHo and uLo. The compressor is switched off after a delay that can be set by parameter ucd. The compressor starts again when the voltage returns within the limits set by parameters uHI and uLI.

Par.	Description	Def	Min	Max	UOM	User	User terminal
c1	Min time between consecutive compressor starts	0	0	15	min	M	NO
c2	Min compressor OFF time	0	0	15	min	M	NO
c3	Min compressor ON time	0	0	15	min	M	NO
ucd	Compressor stop delay after HLVP protection activated	5	0	60	s	M	NO
uDE	Enable display of HLVP protection alarms (EHI and ELO, see alarm table)	0	0	1	-	M	NO
uHi	High voltage protection start threshold	245	0	350	V	M	NO
uHo	High voltage protection end threshold	255	0	350	V	M	NO
uEn	Enable HLVP protection: 0 = disabled; 1 = enabled	0	0	1	-	M	NO
uLi	Low voltage protection start threshold	205	0	350	V	M	NO
uLo	Low voltage protection end threshold	195	0	350	V	M	NO

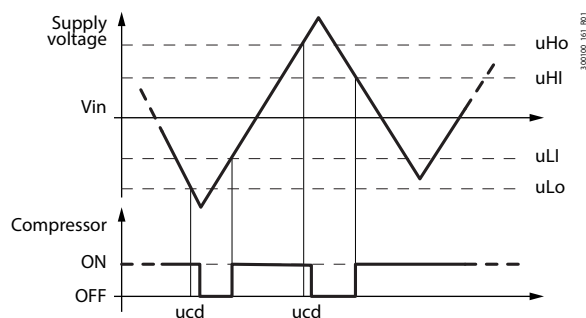

Fig. 6.bp

Notice: the compressor protection times c1 and c3 are ignored when the high or low voltage conditions occur, while c2 is always observed.

Caution:

- this function cannot be considered a compressor safety function;
- operation of the controller outside of the rated operating voltage range described in the technical specifications is the customer's responsibility.

7. PARAMETER TABLE

Below is the table of the parameters that can be displayed on the terminal or can be modified using the configuration software or Applica app. The Applica app and configuration tools have three predefined parameter access levels: User (U), Service (S) and Manufacturer (M).

The default passwords to access the Service and Manufacturer parameters from the Applica app are 22 and 44 respectively. The Manufacturer level password also allows access to the Service parameters, and the level S password also allows access to the User parameters.

Par.	Description	Def	Min	Max	UOM	User	User terminal
PDM	Manufacturer password (OEM)	44	0	999	-	M	NO
PDS	Service password	22	0	999	-	S	NO
PDU	User password	0	0	999	-	U	NO



Notice:

- the read-only parameters are not visible from the Applica app using NFC, as NFC memory cannot be overwritten frequently;
- to avoid any fraudulent activities, the default password values should be changed at the end of the commissioning procedure. For example, with the Applica app, parameters PDM, PDS and PDU can be used to set new passwords, with a maximum length of 3 numbers.



Caution: the operation to reset the default values is not reversible, unless a user recipe has been previously saved for loading using the configuration tool/Applica app, see the paragraph on the configurations.

7.1 Parameter table

Code	Description	Def.	Min	Max	UOM	User	User term.
Analogue inputs							
/2	Analogue probe measurement stability: 0 = probe reading not delayed; ... 15 = maximum probe reading delay.	5	0	9	-	M	NO
/3	Display probe value: 0 = disabled; 1 = fast update; ... 15 = slow update.	0	0	15	-	M	NO
/4	Virtual probe composition: 0 = Outlet probe Sm; 100 = Intake probe Sr	0	0	100	%	S	NO
/5	Unit of measure: 0 = °C; 1 = °F.	0	0	1	-	S	YES
/6	Display decimal point: 0 = Yes; 1 = No.	0	0	1	-	S	YES
/AA	Assign analogue output for modulating evaporator fan: 0 = not configured; 1 = analogue output 1 (Y1); 2 = analogue output 2 (Y2).	0	0	2	-	S	NO
/Ac	Assign analogue output for modulating anti-sweat heaters - see /AA	0	0	2	-	S	NO
/Ad	Assign analogue output for generic modulating function - see /AA	0	0	2	-	S	NO
/AE	Assign analogue output for modulating condenser fan - see /AA	0	0	2	-	S	NO
/AF	Assign analogue output for modulating lights - see /AA	0	0	2	-	S	NO
/AG	Assign analogue output for modulating compressor - see /AA	0	0	2	-	S	NO
/cA	Outlet temperature probe (Sm) calibration	0	-20/ -36	20/ 36	Δ °C/°F	S	NO
/cb	Defrost temperature probe (Sd) calibration	0	-20/ -36	20/ 36	Δ °C/°F	S	NO
/cc	Intake temperature probe (Sr) calibration	0	-20/ -36	20/ 36	Δ °C/°F	S	NO
/cF	Auxiliary evaporator defrost temperature probe (Sd2) calibration	0	-20/ -36	20/ 36	Δ °C/°F	S	NO
/cG	Auxiliary temperature probe 1 calibration	0	-20/ -36	20/ 36	Δ °C/°F	S	NO
/cH	Auxiliary temperature probe 2 calibration	0	-20/ -36	20/ 36	Δ °C/°F	S	NO
/cl	Ambient temperature probe calibration	0	-20/ -36	20/ 36	Δ °C/°F	S	NO
/cM	Glass temperature probe calibration	0	-20/ -36	20/ 36	Δ °C/°F	S	NO
/co	Condensing temperature probe calibration	0	-20/ -36	20/ 36	Δ °C/°F	S	NO
/cp	Humidity probe calibration	0	-20	20	Δ %rh	S	NO
/cq	Frost protection temperature probe calibration	0	-20/ -36	20/ 36	Δ °C/°F	S	NO
/cr	Product temperature probe calibration	0	-20/ -36	20/ 36	Δ °C/°F	S	NO

Code	Description	Def.	Min	Max	UOM	User	User term.
/d1	Assign end defrost probe: 1 = outlet temperature (Sm); 2 = defrost temperature (Sd); 3 = intake temperature (Sr); 4 = not used; 5 = not used; 6 = auxiliary evaporator defrost temperature (Sd2); 7 = auxiliary probe 1; 8 = auxiliary probe 2; 9 = ambient temperature; 10 = not used; 11 = glass temperature; 12 = not used; 13 = condensing temperature; 14 = humidity; 15 = frost protection temperature; 16 = product temperature	2	1	16	-	M	NO
/d2	Assign auxiliary evaporator end defrost probe - see /d1	6	1	16	-	M	NO
/FA	Assign outlet temperature probe (Sm) 0 = Function disabled 1 = Probe S1 2 = Probe S2 3 = Probe S3 4 = Probe S4 5 = Reserved 6 = Probe S1H 7 = Probe S2H	1	0	7	-	S	NO
/Fb	Assign defrost temperature probe (Sd) - see /FA	0	0	7	-	S	NO
/Fc	Assign intake temperature probe (Sr) - see /FA	0	0	7	-	S	NO
/FF	Assign auxiliary evaporator defrost temperat. probe (Sd2) - see /FA	0	0	7	-	S	NO
/FG	Assign auxiliary temperature probe 1 (Saux1) - see /FA	0	0	7	-	S	NO
/FH	Assign auxiliary temperature probe 2 (Saux1) - see /FA	0	0	7	-	S	NO
/FI	Assign ambient temperature probe (SA) - see /FA	0	0	7	-	S	NO
/FM	Assign glass temperature probe (Svt) - see /FA	0	0	7	-	S	NO
/Fo	Assign condensing temperature probe - see /FA	0	0	7	-	S	NO
/FP	Assign humidity probe (fixed on S5)	5	5	5	-	S	NO
/Fq	Assign frost protection temperature probe - see /FA	0	0	7	-	S	NO
/FR	Assign product temperature probe - see /FA	0	0	7	-	S	NO
/Lb	Status LEDs on in standby (including ON/OFF): 0 = off; 1 = on.	0	0	1	-	M	NO
/nE	Enable user terminal navigation: 0 = enabled; 1 = disabled.	0	0	1	-	M	NO
/P1	Configuration of probes S1, S2, S3, S4, B5 0 = PT1000; 1 = PTC; 2 = NTC; 3 = NTC-LT; 4 = NTC-HT.	2	0	4	-	M	NO
/P2	Configuration of multifunction input S3/ DI1: 0, 1, 2, 3, 4 = S3; 5 = DI1.	5	0	5	-	M	NO
/P5	Configuration of analogue output Y1: 7 = 0-10 V; 8 = PWM.	8	7	8	-	S	NO
/P6	Configuration of analogue output Y2: 7 = 0-10 V; 8 = PWM.	8	7	8	-	S	NO
/P7	Configuration of multifunction input S2H/ DIH: 0 = S2H; 5 = DI1.	2	0	2	-	M	NO
/P8	Configuration of probe S1H, S2H: 0 = not used; 1 = not used; 2 = NTC; 3 = not used; 4 = not used	2	0	4	-	M	NO
/Sb	PRG button always ON in standby: 0 = off; 1 = on.	1	0	1	-	M	NO
/ta	Alternating (temperature/humidity): 0 = disabled; 1 = enabled.	0	0	1	-	S	NO
/t1	Display on user terminal: 0 = Not configured; 1 = value of S1; 2 = value of S2; 3 = value of S3; 4 = value of S4; 5 = value of S1H; 6 to 8 = not available; 9 = control probe; 10 = virtual probe; 11 to 14 = not available; 15 = current control set point.	9	0	15	-	S	YES
A0	High and low temp. alarm reset differential	2/ 3.6	0.1/0.2	20/ 36	Δ °C/°F	M	NO
A1	Alarm thresholds (AL, AH) relative to the set point St or absolute: 0 = relative; 1 = absolute.	0	0	1	-	S	NO
A3	Defrost terminated after maximum time signal: 0 = disabled; 1 = enabled.	0	0	1	-	S	NO
A6	Stop compressor with external alarm (Toff = 15 minutes, fixed): 0 = compressor always OFF; 100 = compressor always ON.	0	0	100	min	M	NO
A7	Delay time for delayed external alarm (0 = signal-only alarm)	0	0	240	min	M	NO
Ac	Dirty condenser alarm threshold	70/158	0/ 32	250/482	°C/°F	M	NO
Acd	Dirty condenser alarm delay time	0	0	240	min	M	NO
Ad	Delay time for high and low temp. alarms (AH, AL)	120	0	240	min	U	YES
Add	High temp. alarm bypass time for door open	5	1	240	min	U	YES
AE	Dirty condenser alarm reset differential	5	0.1/0.2	20/ 36	Δ °C/°F	S	NO
AF	Frost protection alarm threshold	-5/ -9	-50/ -58	200/392	°C/°F	S	NO
AFd	Frost protection alarm delay time	1	0	15	min	S	NO
AH	Relative high temperature alarm threshold	0	0	555/999	Δ °C/°F	U	YES
AHA	Absolute high temperature alarm threshold	537/999	-100/-148	537/999	°C/°F	U	YES
AL	Relative low temperature alarm threshold	0	0	200/360	Δ °C/°F	U	YES
ALA	Absolute low temperature alarm threshold	-100/-148	-100/-148	537/999	°C/°F	U	YES
AoutActTestMode[1]	Test via BMS serial port, analogue output Y1 value	0	0	1000	% x 10 (*)		NO
AoutActTestMode[2]	Test via BMS serial port, analogue output Y2 value	0	0	1000	% x 10 (*)		NO
AuC	Activate auxiliary output	0	0	1	-	S	NO

Code	Description	Def.	Min	Max	UOM	User	User term.
BtE	Enable Bluetooth™ connection: 0 = disabled; 1 = enabled.	1	0	1	-	M	NO
c0	Delay to enable compressor and evaporator fan at power on	0	0	15	min	M	NO
c1	Min time between consecutive compressor starts	0	0	15	min	M	NO
c10	End pump down: 0 = time; 1 = pressure.	0	0	1	-	M	NO
c11	Second compressor start delay	4	0	250	s	M	NO
c2	Min compressor OFF time	3	0	15	min	M	NO
c3	Min compressor ON time	0	0	15	min	M	NO
c4	ON time for duty setting operation (Toff = 15 minutes, fixed value): 0 = compressor always OFF; 100 = compressor/valve always ON	0	0	100	min	M	NO
c7	Defrost priority over continuous cycle: 0 = continuous cycle has priority; 1 = defrost has priority.	0	0	1	-	M	NO
c8	Compressor start delay after opening the pump down valve	5	0	60	s	M	NO
c9	Restart during pump down: 0 = disabled; 1 = enabled	0	0	1	-	M	NO
cc	Continuous cycle running time (0 = disabled)	0	0	72	hours	M	NO
ccE	Set point delta to end continuous cycle	1.5/ 2.7	0.0/ 0.0	9.9/ 17.8	Δ °C/°F	M	NO
cct	VCC compressor off time	1	0	255	min	M	NO
cdf	VCC compressor frequency for hot gas defrost	140	0	255	hz	M	NO
cdt	VCC compressor PID control derivative term	1	0	255	s	M	NO
cMA	Maximum VCC compressor rotation frequency	150	0	250	hz	M	NO
cMf	Maximum VCC compressor control frequency	100	0	255	hz	M	NO
cMi	VCC compressor switch-off frequency	30	0	250	hz	M	NO
CnC	Continuous cycle request	0	0	1	-	S	NO
cnf	Minimum VCC compressor control frequency	52	0	255	hz	M	NO
CoA	Display alarms detected by the inverter: 0 = display disabled; 1 = display enabled.	1	0	1	-	U	YES
CompFreqAct TestMode	Test via BMS serial port, VCC compressor frequency	0	0	255	hz	(*)	NO
cPr	VCC compressor PID control proportional term	2	0	800	-	M	NO
cPt	Maximum pump down time (0 = pump down disabled)	0	0	900	s	M	NO
cSc	Soft start frequency	53	0	255	hz	M	NO
cSt	Soft start time	5	0	240	s	M	NO
Ctd	Maximum VCC inverter communication failure time before alarm is shown on the display (0 = display disabled)	15	0	60	s	M	NO
ctl	VCC compressor PID control integral term	120	0	999	s	M	NO
cuF	Conversion factor from frequency (Hz) to compressor speed (rpm)	30	0	999	-	M	NO
d0	Type of defrost: 0 = heater by temperature; 1 = hot gas by temperature; 2 = heater by time; 3 = hot gas by time; 4 = heater by time with temperature control.	0	0	4	-	M	NO
d10	Compressor on time for defrost running time mode 0 = function disabled	0	0	240	min	M	NO
d11	Defrost temperature threshold in running time mode	-50/ -58	-50/ -58	50/ 122	°C/°F	M	NO
d15	Start defrost threshold	0	0	240	min	M	NO
d16	Time with no temperature decrease before starting defrost	30	Add	240	min	M	NO
d20	Sampling time for alarm rSF	0	0	240	min	M	NO
d21	Number of defrosts allowed before signalling alarm rSF	2	1	5	-	M	NO
d22	Temperature difference to verify decrease	0.1/ 0.2	0.1/ 0.2	0.5/ 0.9	Δ °C/°F	M	NO
d4	Enable defrost at power on: 0 = disabled; 1 = enabled.	0	0	1	-	M	NO
d5	Defrost delay at power on or after command from digital input	0	0	240	min	M	NO
d6	Display on terminals during defrosts: 0 = temperature alternating with 'DEF'; 1 = freeze display; 2 = 'dEF'.	1	0	2	-	S	YES
d7	Skip defrost: 0 = disabled; 1 = enabled.	0	0	1	-	M	NO
d8	Bypass high temperature alarm time after defrost	1	1	240	hours	S	YES
d9	Defrost priority over compressor protection times: 0 = the compressor protection times are observed; 1 = the compressor protection times are ignored, therefore defrosting starts without waiting for the compressor protection times to elapse	0	0	1	-	M	NO
dAS	Activate ECO mode	0	0	1	-	S	NO
dC	Time base for defrosts: 0 = dl in hours, dP1 and dP2 in minutes; 1 = dl in minutes, dP1 and dP2 in seconds.	0	0	1	-	S	NO
dC1	Time base for d8: 0 = d8 in hours; 1 = d8 in minutes	0	0	1	-	S	NO
dcH	Defrost after opening the door: maximum number of openings	50	dcL	99	-	M	NO
dcL	Defrost after opening the door: minimum number of openings	0	0	dCH	-	M	NO
dd	Dripping time after defrosting (0 = no dripping)	2	0	15	min	M	NO
ddF	VCC compressor frequency for dripping	140	cMi	255	hz	M	NO
dfM	Start defrost	0	0	1	-	S	NO
dHA	Drain heater activation time before defrosting	3	1	120	min	M	NO
dHE	Drain heater activation time after defrosting	3	1	120	min	M	NO
dHG	Waiting time for compressor start to reverse cycle	0	1	300	s	M	NO
dl	Maximum interval between consecutive defrosts	8	0	240	hours	S	YES
DIA	Assign immediate external alarm digital input: 0 = Disabled; 1 = ID1; 2 = ID2; 3 = D1H; 4 = D2H	0	0	4	-	S	NO
Dlb	Assign delayed external alarm digital input - see DIA	0	0	4	-	S	NO

Code	Description	Def.	Min	Max	UOM	User	User term.
Dlc	Assign enable defrost digital input - see DIA	0	0	4	-	S	NO
Dld	Assign start defrost digital input - see DIA	0	0	4	-	S	NO
DIE	Assign door switch with compressor OFF digital input - see DIA	0	0	4	-	S	NO
DIF	Assign remote ON/OFF digital input - see DIA	0	0	4	-	S	NO
DIG	Assign curtain switch digital input - see DIA	0	0	4	-	S	NO
DIH	Assign start/stop continuous cycle digital input - see DIA	0	0	4	-	S	NO
Dlo	Assign working parameter set changeover digital input - see DIA	0	0	4	-	S	NO
DIP	Assign door switch without compressor OFF digital input - see DIA	0	0	4	-	S	NO
DIS	Assign generic function alarm digital input logic - see DIA	0	0	4	-	S	NO
Dlt	Assign low pressure switch digital input - see DIA	0	0	4	-	S	NO
DIU	Assign AUX output activation digital input - see DIA	0	0	4	-	S	NO
dn	Nominal defrost duration for skip defrost	75	0	100	%	M	NO
dnM	Maximum defrost duration for skip defrost	45	0	240	min	M	NO
DOA	Assign solenoid/compressor digital output 0 = not configured 4 = digital output 4 (NO4) 1 = digital output 1 (NO1) 5 = digital output 5 (NO5) 2 = digital output 2 (NO2) 6 = digital output 6 (NO6) 3 = digital output 3 (NO3)	1 (small) / 5 (large)	0	6	-	S	NO
DOb	Assign alarm digital output - see DOA	0 (small) / 2 (large)	0	6	-	S	NO
DOC	Assign AUX auxiliary digital output - see DOA	0 (small) / 1 (large)	0	6	-	S	NO
DOE	Assign light digital output - see DOA	4 (small) / 3 (large)	0	6	-	S	NO
DOG	Assign defrost digital output - see DOA	2 (small) / 6 (large)	0	6	-	S	NO
DOH	Assign auxiliary evaporator defrost digital output - see DOA	0	0	6	-	S	NO
DOI	Assign evaporator fan digital output - see DOA	3 (small) / 4 (large)	0	6	-	S	NO
DOj	Assign dehumidification digital output - see DOA	0	0	6	-	S	NO
DOn	Assign pump down valve digital output - see DOA	0	0	6	-	S	NO
DOP	Assign drain heater digital output - see DOA	0	0	6	-	S	NO
DOQ	Assign anti-sweat heater digital output - see DOA	0	0	6	-	S	NO
DOS	Assign generic On/Off function digital output - see DOA	0	0	6	-	S	NO
DOT	Assign condenser fan digital output - see DOA	0	0	6	-	S	NO
DOu	Assign humidification digital output - see DOA	0	0	6	-	S	NO
DOv	Assign reverse digital output with dead band control - see DOA	0	0	6	-	S	NO
DOw	Assign auxiliary parallel compressor digital output - see DOA	0	0	6	-	S	NO
DOx	Assign gasket heater digital output - see DOA	0	0	6	-	S	NO
DOy	Assign auxiliary compressor with rotation digital output - see DOA	0	0	6	-	S	NO
DOz	Assign external dehumidifier digital output - see DOA	0	0	6	-	S	NO
dP1	Maximum defrost duration	45	1	240	min	S	YES
dP2	Max auxiliary evaporator defrost duration	45	1	240	min	S	YES
dPH	Defrost after opening the door: maximum defrost duration	15	dPL	dP1	min	M	NO
dPL	Defrost after opening the door: minimum defrost duration	5	0	dPH	min	M	NO
dS1	Compressor off time in sequential stop defrost mode (0 = function disabled)	0	0	45	min	M	NO
dS2	Compressor operating time in sequential stop defrost mode	120	0	240	min	M	NO
dt1	End defrost temperature (read by Sd)	4/39.2	-50/ -58	50/ 122	°C/°F	S	YES
dt2	Auxiliary evaporator end defrost temperature (read by Sd2)	4/39.2	-50/ -58	50/ 122	°C/°F	S	YES
F0	Evaporator fan management: 0 = always on; 1 = activation based on Sd - Sv; 2 = activation based on Sd; 3 = activation based on Sv.	0	0	3	-	S	NO
F00	Condenser fan management: 0 = always on with compressor on 1 = activation based on Sc, off with compressor off.	0	0	1	-	S	NO
F1	Evaporator fan activation threshold (only if F0 = 1, 2, 3)	5/ 41	-50/ -58	50/ 122	°C/°F	S	NO
F10	Evaporator fan forcing time at maximum speed (0 = function disabled)	0	0	240	min	M	NO
F11	Fan ON time with low humidity level	60	0	600	s	M	NO
F12	Fan OFF time with low humidity level	120	0	600	s	M	NO
F13	Fan ON time with medium humidity level	120	0	600	s	M	NO
F14	Fan OFF time with medium humidity level	120	0	600	s	M	NO
F15	Fan ON time with high humidity level	180	0	600	s	M	NO
F16	Fan OFF time with high humidity level	120	0	600	s	M	NO
F17	Temperature control differential for compressor activation with low humidity level	2.0/ 3.6	0.1/ 0.2	20/ 36	Δ °C/°F	M	NO
F18	Temperature control differential for compressor activation with medium humidity level	2.0/ 3.6	0.1/ 0.2	20/ 36	Δ °C/°F	M	NO

Code	Description	Def.	Min	Max	UOM	User	User term.
F19	Temperature control differential for compressor activation with high humidity level	2.0/ 3.6	0.1/ 0.2	20/ 36	Δ °C/ °F	M	NO
F2	Evaporator fans with compressor off: 0 = see F0; 1 = always off with compressor off; 2 = on for anti-stratification; 3 = on for humidity control.	1	0	3	-	S	NO
F20	Modulating evaporator fan speed with low humidity level	10	0	100	%	M	NO
F21	Modulating evaporator fan speed with medium humidity level	20	0	100	%	M	NO
F22	Modulating evaporator fan speed with high humidity level	30	0	100	%	M	NO
F3	Evaporator fans during defrosts: 0 = on; 1 = off.	1	0	1	-	S	NO
F4	Condenser fan deactivation temperature	40/ 104	-50/ -58	200/ 392	°C/°F	S	NO
F4r	Humidification output during defrosts: 0 = active based on humidity control; 1 = deactivated during defrosts	1	0	1	-	M	NO
F5	Evaporator fan cut-off temperature (hyst. 1°C)	5/41	F1	200/392	°C/°F	M	NO
F5d	Condenser fan activation differential	5/ 9	0.1/ 0.2	60/ 108	Δ °C/ °F	S	NO
F6	Maximum evaporator fan speed	100	F7	100	%	M	NO
F7	Minimum evaporator fan speed	0	0	F6	%	M	NO
F7h	Minimum evaporator fan speed during humidification	10	0	100	%	M	NO
F8	Evaporator fan start-up time (0 = function disabled)	0	0	240	s	M	NO
FCC	Modulating condenser fan cut-off temperature	2/ 3.6	0	50/ 90	°C/°F	M	NO
FCH	Maximum modulating condenser fan speed	100	0	100	%	M	NO
FCL	Minimum modulating condenser fan speed	0	0	100	%	M	NO
Fct_ALr_disable	Disable "Display alarms" direct function: 0 = direct function visible (if available); 1 = direct function not visible.	0	0	1	-	(**)	NO
Fct_Auc_disable	Disable "Activate auxiliary output" direct function - see Fct_ALr_disable	0	0	1	-	(**)	NO
Fct_BtE_disable	Disable "Enable Bluetooth" direct function - see Fct_ALr_disable	0	0	1	-	(**)	NO
Fct_CnC_disable	Disable "Activate continuous cycle" direct function - see Fct_ALr_disable	0	0	1	-	(**)	NO
Fct_dFM_disable	Disable "Start defrost" direct function - see Fct_ALr_disable	0	0	1	-	(**)	NO
Fct_Ec1_disable	Disable "Load embedded configurazion 1" direct function - see Fct_ALr_disable	0	0	1	-	(**)	NO
Fct_Ec2_disable	Disable "Load embedded configurazion 2" direct function - see Fct_ALr_disable	0	0	1	-	(**)	NO
Fct_Eco_disable	Disable "Activate ECO mode" direct function - see Fct_ALr_disable	0	0	1	-	(**)	NO
Fct_Fr_disable	Disable "Firmware version" direct function - see Fct_ALr_disable	0	0	1	-	(**)	NO
Fct_HAC_disable	Disable "Direct access to HACCP menu" direct function - see Fct_ALr_disable	0	0	1	-	(**)	NO
Fct_HL_disable	Disable "Dim Light" direct function - see Fct_ALr_disable	0	0	1	-	(**)	NO
Fct_HU_disable	Disable "Set humidity level" direct function - see Fct_ALr_disable	0	0	1	-	(**)	NO
Fct_Lht_disable	Disable "Activate lights" direct function - see Fct_ALr_disable	0	0	1	-	(**)	NO
Fct_nFE_disable	Disable "Enable NFC memory reading" direct function - see Fct_ALr_disable	0	0	1	-	(**)	NO
Fct_OnF_disable	Disable "Unit On/Off" direct function - see Fct_ALr_disable	0	0	1	-	(**)	NO
Fct_Pd_disable	Disable "Activate pull down" direct function - see Fct_ALr_disable	0	0	1	-	(**)	NO
Fct_rH_disable	Disable "Maximum value of control probe" direct function - see Fct_ALr_disable	0	0	1	-	(**)	NO
Fct_rL_disable	Disable "Minimum value of control probe" direct function - see Fct_ALr_disable	0	0	1	-	(**)	NO
Fct_rTL_disable	Disable "Reset min/max control probe" direct function - see Fct_ALr_disable	0	0	1	-	(**)	NO
Fct_SAh_disable	Disable "Display alarm log" direct function - see Fct_ALr_disable	0	0	1	-	(**)	NO
Fct_Sc_disable	Disable "Condenser probe" direct function - see Fct_ALr_disable	0	0	1	-	(**)	NO
Fct_Sc1_disable	Disable "Quick Set point 1" direct function - see Fct_ALr_disable	0	0	1	-	(**)	NO
Fct_Sc2_disable	Disable "Quick Set point 2" direct function - see Fct_ALr_disable	0	0	1	-	(**)	NO
Fct_Sc3_disable	Disable "Quick Set point 3" direct function - see Fct_ALr_disable	0	0	1	-	(**)	NO
Fct_Sd_disable	Disable "Defrost probe" direct function - see Fct_ALr_disable	0	0	1	-	(**)	NO
Fct_SHu_disable	Disable "Humidity probe" direct function - see Fct_ALr_disable	0	0	1	-	(**)	NO
Fct_Sm_disable	Disable "Outlet probe" direct function - see Fct_ALr_disable	0	0	1	-	(**)	NO
Fct_SPR_disable	Disable "Product probe" direct function - see Fct_ALr_disable	0	0	1	-	(**)	NO
Fct_SrG_disable	Disable "Control probe" direct function - see Fct_ALr_disable	0	0	1	-	(**)	NO
Fct_St_disable	Disable "Set control set point" direct function - see Fct_ALr_disable	0	0	1	-	(**)	NO
Fct_Sth_disable	Disable "Set humidity set point" direct function - see Fct_ALr_disable	0	0	1	-	(**)	NO
Fd	Post-dripping time after defrost (fans off with control active)	2	0	15	min	M	NO

Code	Description	Def.	Min	Max	UOM	User	User term.
Fd0	Evaporator fan ON time for anti-stratification during the day	5	1	100	min	M	NO
FdF	Evaporator fan OFF time for anti-stratification during the day (0 = always ON during the day)	10	0	100	min	M	NO
Fn0	Evaporator fan ON time for anti-stratification at night	5	1	100	min	M	NO
FnF	Evaporator fan OFF time for anti-stratification at night (0 = always ON at night)	20	0	100	min	M	NO
Fpd	Evaporator fans during post-dripping: 0 = on; 1 = off.	1	0	1	-	M	NO
Frd	Evaporator fan activation differential (including variable speed)	2/ 3.6	0.1/ 0.2	20/ 36	Δ °C/°F	S	NO
FSh	Modulating evaporator fan speed in dehumidification	40	0	100	%	M	NO
GFA_1	Generic alarm function, control probe 1 0 = not configured; 1 = outlet temperature (Sm); 2 = defrost temperature (Sd); 3 = intake temperature (Sr); 4 = not used; 5 = not used; 6 = auxiliary evaporator defrost temperature (Sd2); 7 = auxiliary probe 1; 8 = auxiliary probe 2; 9 = ambient temperature; 10 = not used; 11 = glass temperature; 12 = not used; 13 = condensing temperature; 14 = humidity; 15 = frost protection temperature; 16 = product temperature.	0	0	16	-	M	NO
GFA_2	Generic alarm function, control probe 2 - see GFA_1	0	0	20	-	M	NO
GFA_D	Generic alarm function, differential	0.1	0.1	99.9	-	S	NO
GFA_De	General alarm function, delay	0	0	30000	S	S	NO
GFA_E	Generic alarm function, enable 0 = always; 1 = unit ON; 2 = unit OFF; 3 = defrost; 4 = not used; 5 = continuous cycle; 6 = duty setting; 7 = standby; 8 = compressor or reverse output active; 9 = door open; 10 = active alarm.	8	0	10	-	M	NO
GFA_Hth	Generic alarm function, high temperature threshold	0	GFA_Lth	999	-	S	NO
GFA_Lth	General alarm function, low temperature threshold	0	-99	GFA_Hth	-	S	NO
GFM_1	Generic modulating function, control probe 1 - see GFA_1	0	0	20	-	M	NO
GFM_2	Generic modulating function, control probe 2 - see GFA_1	0	0	20	-	M	NO
GFM_CD	Generic modulating function, cut-off differential	0.1	0.1	20	-	S	NO
GFM_D	Generic modulating function, differential	0.1	0.1	99.9	-	S	NO
GFM_E	Generic modulating function, enable - see GFA_E	8	0	10	-	M	NO
GFM_H	Generic modulating function, hysteresis	0.1	0.1	20	-	M	NO
GFM_Kp	Generic modulating function, proportional gain	0	0	100	-	M	NO
GFM_Max	Generic modulating function, max output value	0	0	100	%	M	NO
GFM_Min	Generic modulating function, min output value	0	0	100	%	M	NO
GFM_S	Generic modulating function, set point	0	-99	999	-	S	NO
GFM_T	Generic modulating function, type: 0 = direct; 1 = reverse.	0	0	1	-	M	NO
GFM_Td	Generic modulating function, derivative time	0	0	100	s	S	NO
GFM_Ti	Generic modulating function, integral time	0	0	900	s	S	NO
GFS_1	Generic On/Off function, control probe 1 - see GFA_1	0	0	16	-	M	NO
GFS_2	Generic On/Off function, control probe 2 - see GFA_1	0	0	16	-	M	NO
GFS_D	Generic On/Off function, differential	0	0	99.9	-	S	NO
GFS_E	Generic On/Off function, enable - see GFA_E	8	0	10	-	M	NO
GFS_S	Generic On/Off function, set point	0	-99	999	-	M	NO
GFS_T	Generic On/Off function, type: 0 = direct; 1 = reverse.	0	0	1	-	M	NO
H0	Serial address	1	1	247	-	S	YES
H10	BMS serial port baud rate (bit/s) 0 = 1200 3 = 9600 6 = 57600 1 = 2400 4 = 19200 7 = 115200 2 = 4800 5 = 38400	4	0	8	-	S	YES
H11	BMS serial port configuration (stop bits and parity) 0 = 1 stop bit, no parity; 1 = 2 stop bits, no parity; 2 = 1 stop bit, even parity; 3 = 2 stop bits, even parity; 4 = 1 stop bit, odd parity; 5 = 2 stop bits, odd parity;	1	0	5	-	S	YES
H14	Time light stays on after closing the door	0	0	240	min	U	NO
H8	Output switched with time bands: 0 = Light; 1 = AUX.	0	0	1	-	S	NO
HA1, HA2, HA3	Activation date and time of the first, second and third type HA alarm	-	-	-	-	U	NO
HAn	Number of type HA alarms	0	0	6	-	U	YES
Hb	Buzzer: 0 = disabled; 1 = enabled.	1	0	1	-	U	YES
Hdh	Delta for anti-heating function	0	0	200/360	Δ °C/°F	M	NO
HF1, HF2, HF3	Activation date and time of the first, second and third type HF alarm	-	-	-	-	U	NO
HFn	Number of type HF alarms	0	0	6	-	S	YES
HL	Modulating light output activation percentage: 0 = 0%; 1 = 25%; 2 = 50%; 3 = 75%; 4 = 100%.	2	0	4	-	U	NO
HMP	Operating hour threshold for maintenance alarm	hx1000	0	45	0	M	NO

Code	Description	Def.	Min	Max	UOM	User	User term.
HMr	Reset operating hours	-	0	1	0	S	NO
Htd	HACCP alarm delay (0 = monitoring disabled)	0	0	240	min	S	NO
HU	Humidity level: 0: low; 1: medium; 2: high.	1	0	2	-	U	YES
IS	Working configuration	0	0	IS_Max	-	S	YES
IS_max	Number of embedded configurations	0	0	999	-	M	NO
MA1	Test mode, activate analogue output 1: 0 = disabled; 1 = automatic; 2 = activated at the value of MAr1.	0	0	1	-	S	NO
MA2	Test mode, activate analogue output 2 - see MA1	0	0	1	-	S	NO
MAr1	Test mode, analogue output 1 request	0	0	100	%	S	NO
MAr2	Test mode, analogue output 2 request	0	0	100	%	S	NO
Mr1	Test mode, activate relay 1: 0 = disabled; 1 = automatic; 2 = activated.	1	0	2	-	S	NO
Mr2	Test mode, activate relay 2 - see Mr1	1	0	2	-	S	NO
Mr3	Test mode, activate relay 3 - see Mr1	1	0	2	-	S	NO
Mr4	Test mode, activate relay 4 - see Mr1	1	0	2	-	S	NO
Mr5	Test mode, activate relay 5 - see Mr1	1	0	2	-	S	NO
Mr6	Test mode, activate relay 6 - see Mr1	1	0	2	-	S	NO
Mt	Manual mode duration (0 = manual mode always active)	10	0	90	min	S	NO
nFE	Enable NFC memory: 0 = copy parameters disabled; 1 = copy parameters enabled.	1	0	1	-	M	NO
OfT	Gasket heater OFF time	3	0	250	min	M	NO
On	On/Off command 0 = Off; 1 = On.	1	0	1	-	U	YES (button)
OnT	Gasket heater ON time	5	0	250	min	M	NO
PDM	Manufacturer password (OEM)	44	0	999	-	M	NO
PDS	Service password	22	0	999	-	S	NO
PDU	User password	0	0	999	-	U	NO
r1	Minimum set point	-50/ -58	-99/ -146.2	r2	°C/°F	M	NO
r2	Maximum set point	50/ 122	r1	200/ 392	°C/°F	M	NO
r30	Control mode: 0 = direct with defrost; 1 = direct; 2 = reverse	0	0	2	-	M	NO
r4	Automatic night set point variation	3/5.4	-50/ -90	50/ 90	Δ °C/°F	S	NO
r4d	Temperature control differential in ECO mode	4/ 7.2	0.1/ 0.2	99.9/179.2	Δ °C/°F	S	NO
r5c	Select probe to monitor: 0 = not configured; 1 = outlet temperature (Sm); 2 = defrost temperature (Sd); 3 = intake temperature (Sr); 4 = not used; 5 = not used; 6 = auxiliary evaporator defrost temperature (Sd2); 7 = auxiliary probe 1; 8 = auxiliary probe 2; 9 = ambient temperature; 10 = not used; 11 = glass temperature; 12 = not used; 13 = condensing temperature; 14 = humidity; 15 = frost protection temperature; 16 = product temperature.	3	0	16	-	M	NO
r6a	Control probe for night-time operation: 0 = virtual probe Sv; 1 = intake temperature probe Sr	0	0	1	-	S	NO
rAL	Reset alarm log	0	0	1	-	S	YES
rd	Temperature control differential	2/ 3.6	0.1/ 0.2	99.9/179.2	Δ °C/°F	S	YES
rdh	Humidity control differential	5	0.1	99.9	% rH	S	YES
Rdrh	Gasket heater control differential	2/ 3.6	0.1/ 0.2	20/ 36	Δ °C/°F	M	NO
RelayActTestMode[1]	Test via BMS serial port, activate relay 1	0	0	1	-	(*)	NO
RelayActTestMode[2]	Test via BMS serial port, activate relay 2	0	0	1	-	(*)	NO
RelayActTestMode[3]	Test via BMS serial port, activate relay 3	0	0	1	-	(*)	NO
RelayActTestMode[4]	Test via BMS serial port, activate relay 4	0	0	1	-	(*)	NO
RelayActTestMode[5]	Test via BMS serial port, activate relay 5	0	0	1	-	(*)	NO
RelayActTestMode[6]	Test via BMS serial port, activate relay 6	0	0	1	-	(*)	NO
rHP	Reset HACCP event log	0	0	1	-	U	YES
rHt	Anti-sweat heater or fan activation time (0 = function disabled)	5	0	180	min	M	NO
rHU	Anti-sweat heater or fan activation % (0 = function disabled)	70	0	100	%	M	NO
rIA	Immediate external alarm digital input logic: 0 = direct logic; 1 = reverse logic.	0	0	1	-	S	NO
rIb	Delayed external alarm digital input logic - see rIA	0	0	1	-	S	NO
rIc	Enable defrost digital input logic - see rIA	0	0	1	-	S	NO
rId	Start defrost digital input logic - see rIA	0	0	1	-	S	NO
rIE	Door switch with compressor OFF digital input logic - see rIA	0	0	1	-	S	NO
rIF	Remote ON/OFF digital input logic - see rIA	0	0	1	-	S	NO
rIG	Curtain switch digital input logic - see rIA	0	0	1	-	S	NO
rIH	Start/stop continuous cycle digital input logic - see rIA	0	0	1	-	S	NO
rIo	Working parameter set changeover digital input logic - see rIA	0	0	1	-	S	NO
rIP	Door switch without compressor OFF digital input logic - see rIA	0	0	1	-	S	NO
rIS	Generic function alarm digital input logic - see rIA	0	0	1	-	S	NO

Code	Description	Def.	Min	Max	UOM	User	User term.
rit	Low pressure switch digital input logic - see rIA	0	0	1	-	S	NO
rIU	AUX output activation digital input logic - see rIA	0	0	1	-	S	NO
rM	Enable temperature monitoring: 0 = disabled; 1 = enabled	0	0	1	-	S	YES
rn	Dead band	4/ 7.2	0	60/ 108	Δ °C/°F	S	NO
rnH	Dead band for humidity control	5	0	50.0	Δ % rH	S	NO
ro	Control offset with probe error	0	0	20/ 36	Δ °C/°F	M	NO
rOA	Compressor digital output logic: 0=direct; 1=reverse	0	0	1	-	S	NO
rOb	Alarm digital output logic - see rOA	0	0	1	-	S	NO
rOc	AUX auxiliary digital output logic - see rOA	0	0	1	-	S	NO
rOE	Light digital output logic - see rOA	0	0	1	-	S	NO
rOG	Defrost digital output logic - see rOA	0	0	1	-	S	NO
rOH	Auxiliary evaporator defrost digital output logic - see rOA	0	0	1	-	S	NO
rOI	Evaporator fan digital output logic - see rOA	0	0	1	-	S	NO
rOj	Dehumidification digital output logic - see rOA	0	0	1	-	S	NO
rOk	Auxiliary compressor without rotation digital output logic - see rOA	0	0	1	-	S	NO
rOn	Pump down valve digital output logic - see rOA	0	0	1	-	S	NO
rOP	Drain heater digital output logic - see rOA	0	0	1	-	S	NO
rOq	Anti-sweat heater digital output logic - see rOA	0	0	1	-	S	NO
rOS	Generic On/Off function digital output logic - see rOA	0	0	1	-	S	NO
rOt	Condenser fan digital output logic - see rOA	0	0	1	-	S	NO
rOu	Humidification digital output logic - see rOA	0	0	1	-	S	NO
rOv	Reverse digital output with dead band control logic - see rOA	0	0	1	-	S	NO
rOw	Auxiliary parallel compressor digital output logic - see rOA	0	0	1	-	S	NO
rOx	Gasket heater digital output logic - see rOA	0	0	1	-	S	NO
rOy	Auxiliary compressor with rotation digital output logic - see rOA	0	0	1	-	S	NO
rOz	External dehumidifier digital output logic - see rOA	0	0	1	-	S	NO
rr	Reverse output differential	2/ 3.6	0	20/ 36	Δ °C/°F	S	NO
rrH	Dehumidification differential	5	0	50.0	Δ % rH	S	NO
rS1	Working parameter set associated with open digital input (see par. Dlo)	1	0	IS_max	-	M	NO
rS2	Working parameter set associated with closed digital input (see par. Dlo)	2	0	IS_max	-	M	NO
rSA	Reset alarms	0	0	1	-	S	YES
rSC	Restore default values	0	0	1	-	S	YES
rtL	Reset monitoring period	0	0	1	-	U	YES
Sc1	Custom temperature set point 1	0	r1	r2	°C/°F	M	NO
Sc2	Custom temperature set point 2	0	r1	r2	°C/°F	M	NO
Sc3	Custom temperature set point 3	0	r1	r2	°C/°F	M	NO
Sh1	Custom humidity set point 1	0	0	100	% rH	M	NO
Sh2	Custom humidity set point 2	0	0	100	% rH	M	NO
Sh3	Custom humidity set point 3	0	0	100	% rH	M	NO
St	Temperature control set point	50/ 122	r1	r2	°C/°F	U	YES
St_idx	Custom set point index	0	0	3	-	M	NO
Sth	Humidity control set point	90	0.0	100.0	% rH	U	YES
Strh	Gasket heater control set point	-18/ -0.4	-50/ -58	200/392	°C/°F	S	NO
td1..8-d	Defrost 1 to 8 - day: 0 = event disabled; 1-7 = Monday to Sunday; 8 = Monday to Friday; 9 = Monday to Saturday; 10 = Saturday & Sunday; 11 = every day.	0	0	11	-	S	NO
td1..8-hh	Defrost 1 to 8 - hours	0	0	23	hours	S	NO
td1..8-mm	Defrost 1 to 8 - minutes	0	0	59	minutes	S	NO
td1..8-time	Defrost 1 to 8 (Applica)	0:00:00	0:00:00	23:59:59	-	S	NO
TdL	Differential to enable humidity control	0	0	20/ 36	Δ °C/°F	S	NO
tE1..8-d	End time band 1 to 8 - day, see (td1..8-d)	0	0	11	-	U	NO
tE1..8-hh	End time band 1 to 8 - hours	0	0	23	hours	U	NO
tE1..8-mm	End time band 1 to 8 - minutes	0	0	59	minutes	U	NO
tE1..8-time	End time band 1 to 8 (Applica)	0:00:00	0:00:00	23:59:59	-	U	NO
TestMode	Enable test via BMS serial port	0	0	255	-	(*)	NO
THL	Maximum temperature to enable humidity control	0	-60/ -76	60/ 140	°C/°F	M	NO
TLL	Minimum temperature to enable humidity control	0	-60/ -76	60/ 140	°C/°F	M	NO
tS1..8-d	Start time band 1 to 8 - day, see (td1..8-d)	0	0	11	-	U	NO
tS1..8-hh	Start time band 1 to 8 - hours	0	0	23	hours	U	NO
tS1..8-mm	Start time band 1 to 8 - minutes	0	0	59	minutes	U	NO
tS1..8-time	Start time band 1 to 8 (Applica)	0:00:00	0:00:00	23:59:59	-	U	NO
ucd	Compressor stop delay after HLVP protection activated	5	0	60	s	M	NO
udE	Enable display of HLVP protection alarms (EHI and ELO, see alarm table)	0	0	1	-	M	NO
uHi	High voltage protection start threshold	245	0	350	V	M	NO
uHo	High voltage protection end threshold	255	0	350	V	M	NO
uEn	Enable HLVP protection: 0 = disabled; 1 = enabled.	0	0	1	-	M	NO
uLi	Low voltage protection start threshold	205	0	350	V	M	NO
uLo	Low voltage protection end threshold	195	0	350	V	M	NO
uof	OFF time for humidity duty setting operation	60	c2	120	min	M	NO
uon	ON time for duty setting operation	10	c3	120	min	M	NO

Tab. 7.a

(*) Parameter only available via BMS serial.

(**) Parameter only available via the configuration tool.

7.2 Configuring the iJF controller via the Applica app

The “Applica” app can be used to configure the controller from a mobile device (smartphone, tablet), via NFC (Near Field Communication) or BLE (Bluetooth Low Energy). The app is used to configure the commissioning parameters and set groups of preset parameters according to specific needs (configurations).

Procedure:

1. download the CAREL “Applica” app;
2. (on the mobile device) start the app for commissioning the controller;
3. activate NFC and/or BLE;
4. If using an NFC connection: move the device near to the controller, maximum distance 10 mm, to upload the configuration parameters;
5. If using a BLE connection:
 - 1. select “BLUETOOTH SCAN” to view the iJF controller devices available within a range of 10 m.
 - 2. select the device to connect to

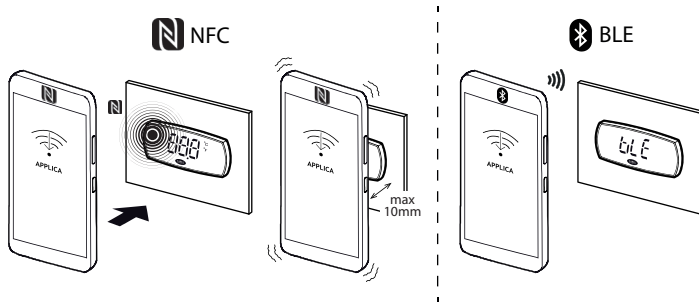

Fig. 7.a

Notice: during the first connection, the Applica app aligns itself with the software version on the iJF controller via a cloud connection; this means a mobile data connection is needed at least for this first connection. If the data connection is not available, the required packet can be retrieved from the cloud as soon as the connection is restored (access the “Packet Manager” section of Applica).

Applica makes it easy to set the parameters on the iJF controller and manage parameter configurations using the hamburger menu at the top left of the screen.

7.2.1 Configurations

Parameter configurations can be created and saved, and then uploaded to the iJF controller using the configuration software or Applica app. Configurations can be created either using the default values loaded by Carel, or starting from user-set values on the iJF controller, or alternatively only certain specific values can be modified.

To create a configuration using the SPARK configuration software - released under license directly by Carel - and starting from the default values on the controller, connect the PC to the BMS connector (RS485) using converter P/N CVSTDUMORO, as shown in the figure:

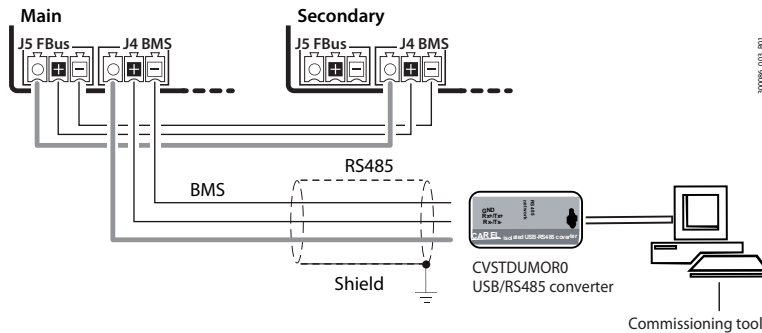

Fig. 7.b

Proceed as follows:

1. After starting the configuration software, from the "File" tab open the configuration file (workspace) provided by Carel;
2. In the "Target" tab add a "target", i.e. the iJF controller to communicate with.
3. Set the type of serial communication and change the connection parameters (default for the iJF baud rate 19200, parity None and 2 stop bit)
4. Select "Connect".
5. From the "Configurations" tab, select "Add configuration" (e.g. 1).
6. After having created and selected the chosen configuration, select "Copy values to configuration".
7. The "Configuration value" column will now be populated with the current values on the iJF controller. The values can now be modified to create a custom configuration.
8. The configuration created as above can be immediately uploaded to the iJF controller by selecting "Applica configuration" or saved for future use by selecting "Export configuration".

Notice: to create a configuration based on the default values loaded by Carel on the iJF controller, simply follow the same procedure as described above, and in step 6 select "Applica default values" rather than "Copy values to configuration".

7.2.2 Profiles

Different profiles can be created for displaying the parameters using the configuration software.

Proceed as follows:

1. After starting the configuration software, open the configuration file provided by Carel;
2. From the "Profiles" tab select "Add profile";
3. Select "Profiling";
4. Select the variables to assign to the profile. These will only be the variables that are visible via the configuration/commissioning software and the Applica app to any M-level user who has the password for profile MyProfile1;
5. Now, selecting profile MyProfile1, the variables to assign to the profile as read-only can be selected by checking the check box in the corresponding column;
6. Select "Edit" to set the password associated with the profile;
7. The profile is now ready to be exported; select "Export profile" and upload it to the cloud service used by the Applica app.

8. TECHNICAL SPECIFICATIONS

Physical specifications	Case	Polycarbonate	
	Ball pressure test temperature	125 °C	
	Ingress protection	IEC: <ul style="list-style-type: none"> • Rear: IP20 • Front: IP65 (Panel small, Panel large with springs, Split small without HMI cable, HMI small, HMI large with springs); IP45 (Split large without HMI cable); IP43 (Panel large without springs, HMI large without springs); IP20 (Split with HMI cable) UL: <ul style="list-style-type: none"> • Type 1 (Panel small, Panel large from -5°C to 60°C, Split small without HMI cable, Split large, HMI small, HMI large from -5°C to 60°C) • Open type (Panel large from -20°C to 60°C, HMI large from -20°C to 60°C) 	
	Front cleaning	Use soft, non-abrasive cloth and neutral detergent or water	
Environmental conditions	Operating temperature	-20T60 °C, <90% RH non-condensing	
	Storage temperature	-40T80 °C, <90% RH non-condensing; -20T80 °C, <90% RH non condensing for models with battery	
Electrical specifications	Rated power supply	<ul style="list-style-type: none"> • 100-240 Vac (Panel, Split); • 12 Vdc, supplied by Carel controller SELV/Class 2 (HMI) 	
	Operating power supply voltage	<ul style="list-style-type: none"> • 90-264 Vac (Panel, Split); • 12 Vdc, supplied by Carel controller SELV/Class 2 (HMI) 	
	Input frequency	50/60Hz (Panel, Split)	
	Maximum current draw	<ul style="list-style-type: none"> • 100 mA rms (Panel small, Split small); • 220 mA rms (Panel large, Split large); • 200 mA, power supply supplied by Carel controller SELV/Class 2 (HMI) 	
	Min power consumption	700 mW (Small, HMI) 800 mW (Large)	
	Clock	Precision: 20 ppm at 25°C; 100 ppm in the temperature range -20T60 °C. Date/time storage with controller off up to 10 years for models with battery (-20T60°C).	
	Software class and structure	A	
	Environmental pollution class	2 (Panel small, Split small) 3 (Panel large, Split large, HMI)	
	Class of protection against electric shock	To be incorporated in class I or II appliances	
	Type of action and disconnection	1.C	
	Rated impulse voltage	100 - 240 Vac input and relay output: 2.5 kV (Small) 100 - 240 Vac input and relay output: 4 kV (Large) 0.5 kV (HMI)	
	Surge immunity category	100 - 240 Vac input and relay outputs: II (Small) 100 - 240 Vac input and relay outputs: III (Large)	
	Control device construction	Device to be incorporated	
	Terminal block	NO1, C1, NO2, NO3, NO4, NO5, C5, C6, NC6, NO6, L, N: <ul style="list-style-type: none"> • Removable male-female 30-12 AWG/0.05-3.3 mm² • Screw terminals 30-14 AWG/0.05-2 mm² • Faston connectors S1, S2, S3, S4, DI1, DI2, S1H, S2H, D1H, D2H, GND (Small, HMI): <ul style="list-style-type: none"> • Removable male-female 30-17 AWG/0.05-1 mm² • Screw terminals 30-17 AWG/0.05-1 mm² S1, S2, S3, S4, DI1, DI2, GND (Large): <ul style="list-style-type: none"> • Removable male-female 30-12 AWG/0.05-3.3 mm² • Screw terminals 30-14 AWG/0.05-2 mm² BMS, 0-5 Vrat: <ul style="list-style-type: none"> • Removable male-female 30-17 AWG/0.05-1 mm² FieldBus, 0-10 V/PWM: <ul style="list-style-type: none"> • JST ZH connector 32-26 AWG/0.03-0.13 mm² Power supply and communication with Carel controller (HMI): <ul style="list-style-type: none"> • JST ZH connector 32-26 AWG/0.03-0.13 mm² • Removable male-female 30-17 AWG/0.05-1 mm² • Screw terminals 30-17 AWG/0.05-1 mm² 	
	Purpose of the controller	Electrical control device	
	User interface	Buzzer	Built-in (Panel, HMI)
		Display	3 digits, decimal point and multifunction icons (Panel, HMI); external HMI (optional, Split)
Keypad		Max 6 buttons (Panel small, HMI small); max 8 buttons (Panel large, HMI large); external HMI (optional, Split)	
LEDs		1 red LED and 1 white LED (Split)	
Connectivity	NFC	Max distance 10 mm, variable according to the mobile device used	
	Bluetooth Low Energy (opt.)	Max distance 10 m, variable according to the mobile device used	
	BMS serial interface (opt.)	RS485 not optically-isolated	
	FieldBUS serial interface (opt.)	RS485, not opto-isolated, maximum number of devices that can be connected: 20	
	HMI interface	RS485, not opto-isolated	
TTL serial interface (opt.)	Not opto-isolated, 3.3 V power supply, maximum number of devices connected: 1		

Analogue inputs (Lmax=10m)	S1, S2, S3, S4: NTC/ NTC-HT/ NTC-LT/ PT1000/ PTC	NTC: resolution 0.1°C; 10 kΩ@25°C; beta 3435; error: ±1°C in the range -50T50°C, ±3°C in the range 50T90°C NTC-HT: resolution 0.1°C; 50 kΩ@25°C; beta 3977; error: ±1.5°C in the range -15T115°C, ±4°C in the range 40T-15°C and 115T150°C. NTC_LT: resolution 0.1°C; 750Ω@25°C; beta 3969; error: ±1.5°C in the range -20T10°C, ±4°C in the range 80T-20°C and 10T55°C PT1000: resolution 0.1°C; 1 kΩ@0°C; error: ± 1°C in the range - 60T120°C PTC: resolution 0.1°C; 985 Ω@25°C; error: ±2 °C in the range -50T50°C, ±4 °C in the range 50T150°C
	S: 0-5 Vrat (opt.)	0-5 Vrat: error 2% fs, typical 1%
	S1H: D1H configurable as NTC S2H: NTC (models IJFHL*)	NTC: resolution 0.1°C; 10 kΩ@25°C; beta 3435; error: ±1°C in the range -50T50°C, ±3°C in the range 50T90°C
Digital inputs	D11, D12 configurable as fast digital inputs	Voltage-free contact, not optically-isolated, typical closing current 5 mA, voltage with contact open 12 V, max contact resistance 50 Ω Fast digital inputs: 0-10 V: error 2 % fs, typical 1 %
	D1H, D2H (HMI)	Voltage-free contact, not optically-isolated, typical closing current 5 mA, voltage with contact open 12 V, max contact resistance 50 Ω
Analogue outputs	Y1, Y2, independently configurable as DC or PWM outputs (opt.)	0-10V: 1 kΩ, 10 mA max PWM: 100 Hz, max amplitude 10 V, 10 mA max
Digital outputs (Small)	NO1, NO2, NO3, NO4	NO1 (2 hp): EN60730: 10(6) A, 250 Vac; UL60730: 16A, 250 Vac; 8FLA, 48LRA, 250 Vac; Pilot duty B300, 250 Vac NO2 (8 A): EN60730: 8(3) A, 240 Vac; UL60730: 8A, 240 Vac; 2FLA, 12LRA, 240 Vac; Pilot duty C300, 240 Vac NO3, NO4 (5 A): EN60730: 5(1) A, 240 Vac; UL60730: 5A, 240 Vac; 1FLA, 6LRA, 240 Vac; Pilot duty C300, 240 Vac
	Notice: with screw or removable terminals, NO1: max 12 A. • NO1: max 12 A; • NO2+NO3+NO4: max 12 A With faston terminals: • NO1: max 14 A; • NO2+NO3+NO4: max 14 A	
Digital outputs (Large)	NO1, NO2, NO3, NO4, NO5, NO6, NC6	NO1, NO2, NO3, NO4 (8 A): IEC60730: 8(3) A, 250 Vac; UL60730: 8 A, 250 Vac; 2FLA, 12LRA, 250 Vac; Pilot duty C300, 250 Vac NO5 (30 A): IEC60730: 20(10) A, 250 Vac; UL60730: 16 A, 250 Vac; 16FLA, 96LRA, 250 Vac NO5 (2 hp): IEC60730: 10(6) A, 250 Vac; UL60730: 16A, 250 Vac; 8FLA, 48LRA, 250 Vac; Pilot duty B300, 250 Vac
	Notice: • NO1+NO2: max 10 A; • NO3+NO4: max 10 A. NO5: 30 A or 2 hp depending on the model, see label. For 30 A version, NO5: • with screw or removable terminals max 12 A. • with faston terminals max 16 A. For 2 hp version, NO5: • with all terminals max 12 A.	
Probe power supply	5 V	5 Vdc ± 2 % to power the 0 to 5 V ratiometric probes. Maximum current delivered: 10 mA
	+V	12 Vdc ± 10% to power the repeater terminal
Cable lengths	Analogue inputs/outputs, digital inputs/ outputs, probe power	< 10 m
	BMS and Fieldbus serial cables	< 500 m with shielded cable
	TTL serial cables	< 2 m
	Controller-HMI	< 10 m. NOTICE: in domestic environments, for connections over 2 m, in applications where controller and HMI are not installed on the same chassis, shielded cable is recommended
Conformity	Electrical safety compliance - LVD directive and UL certification	IEC/EN/UL 60730-1, CSA E60730-1, IEC 60335-1 (sections 29 & 30)
	Electromagnetic compatibility - EMC directive	IEC/EN 61000-6-1, IEC/EN 61000-6-2, IEC/EN 61000-6-3, IEC/EN 61000-6-4
For use with flammable refrigerants, the controllers described in this document have been tested and found to comply with the following requirements of the IEC 60335 series standards: • Annex CC of IEC 60335-2-24: 2010, referred to in clause 22.109, and Annex BB of IEC 60335-2-89: 2010, referred to in clause 22.108; components that produce arcs or sparks during normal operation have been tested and found to comply with the requirements of UL/IEC 60079-15; • IEC/EN/UL 60335-2-24 (clauses 22.109, 22.110) for household refrigerators and freezers; • IEC/EN/UL 60335-2-40 (clauses 22.116, 22.117) for electric heat pumps, air conditioners and dehumidifiers; • IEC/EN/UL 60335-2-89 (clauses 22.108, 22.109) for commercial refrigerating appliances.		
The controllers have been verified for the maximum temperatures of all components, which during the tests required by IEC 60335 cl. 11 and 19 do not exceed 272°C. The acceptability of these controllers in the final application where flammable refrigerants are used needs to be reviewed and verified depending on the final application.		
	Wireless compliance	RED directive (EN 301489-1), FCC (section 15, subsection B), IC.

Tab. 8.a

8.1 Connector/cable table

Ref.	Description	Wiring terminals	Wire cross-section (mm ²)	Lmax (m)
L, N	Controller power supply	Removable screw terminal, 2-pin, pitch 5 mm (Small without options)/5.08 mm (Small with options, Large)	0.05-3.3 (30-12 AWG)	10
		Screw terminals, 2-pin, pitch 5 mm (Small without options)/5.08 mm (Small with options, Large)	0.05-2 (30-14 AWG)	
		Faston connectors	-	
S1 to S3, S4 (Large)	Probes	Removable terminal; 5-pin, pitch 3.81 mm (Small, without options) 2x3 pins, pitch 3.5 mm (Small, with options) 4+3 pins, pitch 5.08 mm (Large)	0.05-3.3 (30-12 AWG)	10
		Screw terminals: 5-pin, pitch 3.81 mm (Small, without options) 2x3 pins, pitch 3.5 mm (Small, with options) 4+3 pins, pitch 5.08 mm (Large)	0.05-2 (30-14 AWG)	
S1H	HMI probe	Removable terminal	0.05-1 (30-17 AWG)	10
		Screw terminal		
S5, 5 V	Ratiometric probe power supply	Removable screw terminal, 2-pin, pitch 3.5 mm	0.05-1 (30-17 AWG)	10
ID1, ID2	Digital inputs	Removable screw terminal, 5-pin, pitch 5.08 mm (Small, without options) 2x3 pins, pitch 3.5 mm (Small, with options) 4+3 pins, pitch 5.08 mm (Large)	0.05-3.3 (30-12 AWG)	10
		Screw terminals, 5-pin, pitch 5.08 mm (Small without options) 2x3 pins, pitch 3.5 mm (Small, with options) 4+3 pins, pitch 5.08 mm (Large)	0.05-2 (30-14 AWG)	
ID1H, ID2H	HMI digital inputs	Removable screw terminal, 5-pin, pitch 3.5 mm	0.05-1 (30-17 AWG)	10
		Screw terminals, 5-pin, pitch 3.5 mm		
NO1 to NO6	Digital outputs	Removable terminal, 5-pin (Small), 4x3-pin (Large), pitch 5.08 mm	0.05-3.3 (30-12 AWG)	10
		Screw terminal, 5-pin (Small), 4x3-pin (Large), pitch 5.08 mm	0.05-2 (30-14 AWG)	
		Faston connectors	-	
Y1, Y2	0-10 V/PWM outputs	JST ZH connector, 4-pin, pitch 2 mm - Connection cable part number (see "Introduction").	0.03-13 (32-26 AWG)	10
BMS	BMS serial	Removable screw terminal, 3-pin, pitch 3.5 mm	0.05-1 (30-17 AWG)	500, 6 with shielded cable
Fieldbus	FieldBus serial (future uses)	JST ZH connector, 4-pin, pitch 2 mm - Connection cable part number (see "Introduction").	0.03-13 (32-26 AWG)	500, 6 with shielded cable
TTL	TTL serial	JST ZH connector, 4-pin, pitch 2 mm - Connection cable part number (see "Introduction").	0.03-13 (32-26 AWG)	2
VCC	VCC serial output	JST ZH connector, 4-pin, pitch 2 mm - Connection cable part number (see "Introduction").	0.03-13 (32-26 AWG)	500, 6 with shielded cable
HMI	HMI remote terminal	JST ZH connector, 4-pin, pitch 2 mm - Connection cable part number (see "Introduction").	0.03-13 (32-26 AWG)	10
		Removable screw terminal, 4-pin, pitch 5.08 mm	0.05-1 (30-17 AWG)	Notice: in domestic environments, for connections over 2 m, in applications where controller and HMI are not installed on the same chassis, shielded cable is recommended
		Screw terminals, 4-pin, pitch 5.08 mm		

Tab. 8.b

9. ALARMS AND SIGNALS

9.1 Signals



Signals are messages shown on the display to notify the user of the control procedures in progress (e.g. defrost) or to confirm keypad input.

Display code	Description
Ble	Bluetooth™ connection in progress
dEF	Defrost running
Loc	Display locked
Off	Switch OFF
On	Switch ON
tSt	Test outputs via BMS serial port active

Tab. 9.a

9.2 Types of alarms

The iJF controller can display two types of malfunctions:

- **warning**, when this type of error occurs, the alarm code is shown on the display, alternating with the main value, the “Service” icon  is shown on the display, however the buzzer does not sound, no relay is activated; errors belonging to this category include defrost ended after maximum time, dirty condenser, HACCP alarms, configuration errors.
- **alarms**, when this type of error occurs, the alarm code is shown on the display, alternating with the main value, and the “Service” icon  comes on, the buzzer flashes and the relay is activated; this category includes alarms for which with the relay is configured as an alarm, probe errors, temperature alarms, frost protection, communication errors with the VCC compressor, power supply over and under voltage, etc.

 **Notice:**

- the digital outputs can be configured to signal the alarm status, normally open or normally closed. See “Digital outputs”.
- An alarm can also be activated from an external contact, immediate or delayed. See “Digital inputs”.

The warning and alarm signals can be immediate or delayed by parameter (see the Alarm table).

Both warnings and alarms can be reset automatically, manually or semi-automatically:

- **automatic**, when the cause is no longer present, the alarm also ceases;
- **manual**, when the cause is no longer present, the alarm remains active until manually reset by parameter;
- **semi-automatic**, reset is automatic 3 times in an hour, after which manual reset is required.

Active alarms are signalled by the buzzer (see parameter Hb) and the flashing of the “Service” icon . The alarm code is shown on the display, alternating with the main value. Pressing any button mutes the buzzer. If more than one error occurs, these are displayed in sequence. When an alarm is cleared, it is stored in the alarm log containing a maximum of five alarms, in a FIFO list (the 6th alarm overwrites the 1st alarm, and so on). The error log can be accessed from the user terminal, via supervisor or Applica app (Bluetooth connection only).

Example

Display after HI error.

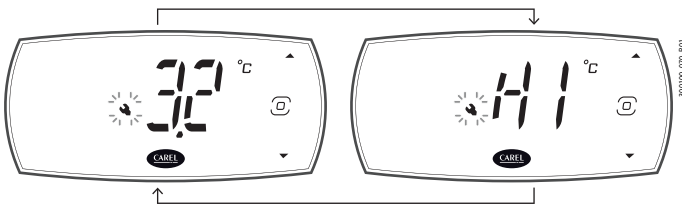



Fig. 9.a

The alarms can be reset manually using parameter rSA, from the user terminal or configuration tool, or in Applica (Bluetooth connection only) using the specific command on the Alarms page (“Service” or “Manufacturer” level access is required). If the condition that generated the alarm is still present, the alarm will be reactivated after resetting.

The alarm log can be deleted using parameter rAL, accessible from the user terminal, configuration tool or in Applica (Bluetooth connection only) using the specific command on the Alarms page (“Service” or “Manufacturer” level access is required).

 **Notice:** deleting the alarm log is irreversible.

9.3 Alarm table

Display code	Log code (*)	Description	Delay (default)	Icon display	Alarm relay	Buzzer	Reset	Effects on control
Afr	29	Frost protection	Afd (1 min)	YES	YES	YES	Automatic	Compressor OFF
AtS	30	Restart in pump down	-	NO	NO	NO	Automatic	-
CE	28	Configuration write error	-	NO	NO	NO	Automatic	-
cht	17	High condensing temperature warning	-	NO	NO	NO	Automatic	-
CHt	18	High condensing temperature alarm	Acd (0 min)	NO	NO	NO	Manual	Compressor OFF
COM	34	VCC communication error	Ctd (15 s)	YES	YES	YES	Automatic	-
dA	14	Delayed alarm from external contact	A7 (1 min)	YES	YES	YES	Automatic	Compressor operation in duty setting mode (par. A6); dead band, lights and auxiliary output OFF
dor	15	Door open	Add (5 s)	YES	YES	YES	Automatic	See "Door management"
E1	1	Probe 1 faulty or disconnected	-	NO	NO	NO	Automatic	According to the associated function
E2	2	Probe 2 faulty or disconnected	-	NO	NO	NO	Automatic	
E3	3	Probe 3 faulty or disconnected	-	NO	NO	NO	Automatic	
E4	4	Probe 4 faulty or disconnected	-	NO	NO	NO	Automatic	
E5	5	Probe 5 faulty or disconnected	-	NO	NO	NO	Automatic	
E6	6	Probe S1H faulty or disconnected	-	NO	NO	NO	Automatic	
E7	7	Probe S2H faulty or disconnected	-	NO	NO	NO	Automatic	
Ed1	10	Defrost terminated after maximum time	-	NO	NO	NO	Automatic	-
Ed2	11	Defrost on second evaporator terminated after maximum time	-	NO	NO	NO	Automatic	-
EHI	36	High power supply voltage alarm	-	YES	YES	YES	Automatic	-
ELO	37	Low power supply voltage alarm	-	YES	YES	YES	Automatic	-
Etc	9	Clock error	-	NO	NO	NO	Manual	Time bands disabled
GHI	19	Generic alarm high threshold	GFA_De (0 s)	YES	YES	YES	Automatic	-
GLO	20	Generic alarm low threshold	GFA_De (0 s)	YES	YES	YES	Automatic	-
HA	21	Type HA HACCP alarm (high temp. during operation)	-	NO	NO	NO	Manual	-
HF	22	Type HF HACCP alarm (high temp. after blackout)	-	NO	NO	NO	Manual	-
HI	24	High temperature	Ad (120 s)	YES	YES	YES	Automatic	-
IA	13	Immediate alarm from external contact	-	YES	YES	YES	Automatic	Compressor operation in duty setting mode (par. A6); dead band OFF
LO	23	Low temperature	Ad (120 s)	YES	YES	YES	Automatic	-
LP	32	Low pressure	-	YES	YES	YES	Semi-automatic	Compressor OFF
MAn	38	Output status overridden in manual mode	-	YES	YES	YES	Automatic	-
Pd	26	Maximum pump down time	-	YES	YES	YES	Automatic	-
rE	12	Control probe faulty or disconnected	-	YES	YES	YES	Automatic	Compressor operation in duty setting mode (par. c4); dead band OFF
rSF	31	Refrigerant leak alarm	-	YES	YES	YES	Manual	Switch off all actuators
SF	27	Configuration not completed correctly	-	NO	NO	NO	Manual	-
SrC	35	Maintenance request	-	YES	YES	YES	Manual	-
UCF	33	VCC operation error	-	YES	YES	YES	Automatic	-

Tab. 9.b

(*) This is the code used to record and display the alarm in Aplica.

9.4 Low and high temperature alarms LO and HI

The high and low temperature alarm thresholds can be relative or absolute, depending on the value of parameter A1:

- A1 = 0: the relative thresholds AL and AH are considered and represent the deviation from the set point; the low temperature alarm is activated at set point - AL, and the high temperature alarm at set point + AH. If the set point changes, the alarm activation point also changes automatically.
- A1 = 1, the absolute thresholds ALA and AHA are considered, representing the absolute low temperature and high temperature alarm threshold, respectively. If the set point changes, the activation point remains the same.

Par.	Description	Def	Min	Max	UOM	User	User terminal
d8	Bypass high temperature alarm time after defrost	30	1	240	min	S	YES
A0	High and low temp. alarm reset differential	2	0.1	20	°C/°F	M	NO
A1	Alarm thresholds (AL, AH) relative to the set point St or absolute: 0 = relative; 1 = absolute	0	0	1	-	S	YES
A6	Stop compressor with external alarm (Toff = 15 minutes, fixed): 0 = compressor always OFF; 100 = compressor always ON	0	0	100	min	M	NO
Ad	Delay time for high and low temp. alarms (AH, AL)	120	0	240	min	U	YES
Add	High temp. alarm bypass time for door open	30	1	240	min	U	YES
AH	Relative high temperature alarm threshold	0	0	555/999	Δ °C/°F	U	YES
AHA	Absolute high temperature alarm threshold	537/999	-100/-148	537/999	°C/°F	U	YES
AL	Relative low temperature alarm threshold	0	0	200/360	Δ °C/°F	U	YES
ALA	Absolute low temperature alarm threshold	-100/-148	-100/-148	537/999	°C/°F	U	YES

Tab. 9.c

Relative thresholds

Parameter AL is used to set the activation threshold for the low temperature alarm LO. The value measured by the control probe is continuously compared against the value of $St-AL$, and if it falls below this value for a time longer than Ad , the low temperature alarm LO is activated. The low temperature alarm LO ceases automatically when the temperature rises back above $St-AL+A0$. Similarly, parameter AH is used to set the activation threshold for the high temperature alarm HI. The value measured by the control probe is continuously compared against the value of $St+AH$, and if it rises above this value for a time longer than Ad , the high temperature alarm HI is activated. The high temperature alarm HI ceases automatically when the probe reading falls below $St+AH-A0$.

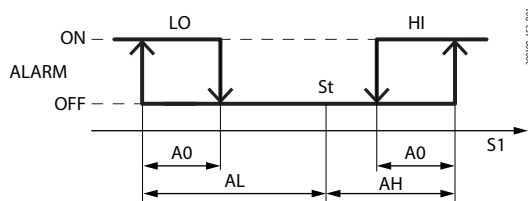

Fig. 9.b

Ref.	Description
LO	Low temperature alarm
HI	High temperature alarm
S1	Control probe
St	Set point
AL	Relative low temperature alarm threshold
AH	Relative high temperature alarm threshold
A0	Return differential

Absolute thresholds

Parameter ALA is used to set the activation threshold for the low temperature alarm LO. The value measured by the control probe is continuously compared against the value of ALA, and if it falls below this value for a time longer than Ad , the low temperature alarm LO is activated. The low temperature alarm LO ceases automatically when the temperature rises back above $ALA+A0$. Similarly, parameter AHA is used to set the activation threshold for the high temperature alarm HI. The value measured by the control probe is continuously compared against the value of AHA, and if it rises above this value for a time longer than Ad , the high temperature alarm HI is activated.

The high temperature alarm HI ceases automatically when the probe reading falls below $AHA-A0$.

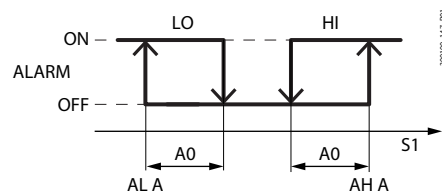

Fig. 9.c

Ref.	Description
LO	Low temperature alarm
HI	High temperature alarm
S1	Control probe
AL	Low temperature alarm threshold
AH	Low temperature alarm threshold
A0	Return differential

The high temperature alarm is ignored for a time set by parameter Add after opening the door, and for parameter $d8$ after defrosting, to avoid false signals. Once the times set by parameter Add or $d8$ have elapsed, the delay set by parameter Ad starts counting and the alarm is signalled when it elapses.

The active low temperature alarm LO is signalled by the buzzer and the code LO shown on the display, while the active high temperature alarm HI is signalled by the buzzer and the code HI.

9.5 HACCP alarms (HACCP = Hazard Analysis and Critical Control Point)

These are specific alarms for controlling the operating temperature, recording any anomalies due to power failures or an increase in the temperature due to other causes (breakages, extreme operating conditions, user errors, etc.); see "HACCP alarm parameters and activating monitoring" for details.

Two types of potentially critical HACCP events are managed:

- type HA alarms, high temperature during operation;
Example: The critical temperature was exceeded, the alarm was not managed and the temperature remained above the threshold for longer than the maximum tolerable time (thresholds defined by site HACCP procedures). The event is critical and potentially hazardous.
 - type HF alarms, high temperature after power failure;
Example: The unit was powered off. When restarted, the temperature is above the threshold and does not return to an acceptable level within an appropriate time (parameters defined by site HACCP procedures). The event is critical and potentially hazardous.
- When an alarm occurs, the HACCP icon comes on (if featured), the display shows the alarm code, the alarm is logged and the alarm relay and buzzer are activated.

9.5.1 HACCP alarm parameters and activating monitoring

Type HA alarms

The type HA alarm is generated if during normal operation the temperature read by the control probe exceeds the high temperature threshold for the time Ad+Htd. Consequently, compared to the normal high temperature alarm already signalled by the controller, the type HA HACCP alarm is delayed by a further time Htd specifically for HACCP recording.

Par.	Description	Def	Min	Max	UOM	User	User terminal
Htd	HACCP alarm delay 0 = monitoring disabled	0	0	240	min	M	NO

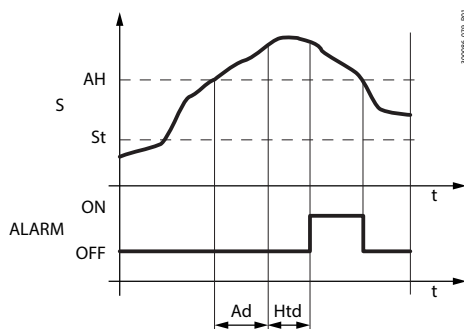

Ref.	Description
S	Control probe
St	Set point
ALARM	Type HA HACCP alarm
Ad	Delay time for high and low temperature alarms
AH	Low temperature alarm threshold
Htd	HACCP alarm delay - 0 = monitoring disabled
t	Time

Fig. 9.d

Code	Description	Def	Min	Max	UOM	User	User terminal
HAn	Number of type HA alarms	0	0	6	-	U	YES
HA1, HA2, HA3 (*)	Activation date and time of the first, second and third type HA alarm	-	U	NO

Type HF alarms

The type HF HACCP alarm is generated following a power failure, if when power returns the temperature read by the control probe exceeds the AH high temperature threshold. HF_n indicates the number of type HF alarms activated.

Par.	Description	Def	Min	Max	UOM	User	User terminal
HF _n	Number of type HF alarms	0	0	6	-	U	YES
HF1, HF2, HF3 (*)	Activation date and time of the first, second and third type HF alarm	-	U	NO

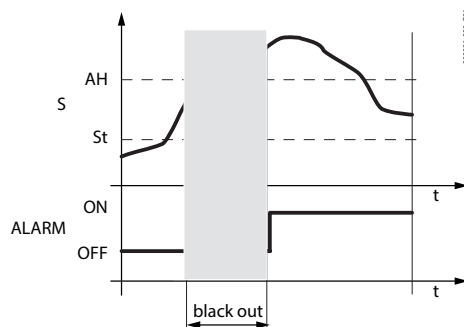

Ref.	Description
S	Control probe
St	Set point
ALARM	Type HF HACCP alarm
AH	Low temperature alarm threshold
t	Time

Fig. 9.e

(*) Parameters visible in APPLICA.

The HA and HF alarms can be reset using parameter rSA.

The HACCP event log can be deleted using parameter rHP, from the configuration tool or in the Applica app (Bluetooth connection only).

Notice: deleting the HACCP event log is irreversible.

9.6 Dirty condenser alarm

If the condensing temperature probe is fitted, the iJF controller can monitor the reading so as to signal a dirty condenser alarm.

Par.	Description	Def.	Min	Max	UOM	User	User terminal
/Fo	Assign condensing temperature probe:	0	0	7	-	S	NO
	0 disabled	4	S4				
	1 S1	5	reserved				
	2 S2	6	S1H				
	3 S3	7	S2H				
Ac	Dirty condenser alarm threshold	70/158	0/32	250/482	°C/°F	S	NO
AE	Dirty condenser alarm differential	5/9	0.1/0.2	20/36	Δ °C/°F	S	NO
ACd	Dirty condenser alarm delay	0	0	240	min	M	NO

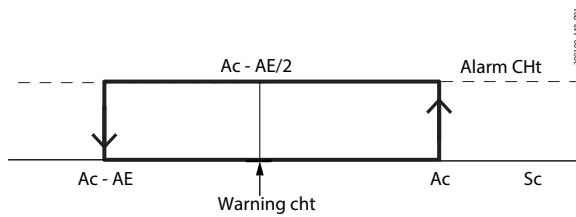

Ref.	Description
Sc	Condensing temperature probe reading
Ac	Dirty condenser alarm threshold
AE	Dirty condenser alarm differential
ACd	Dirty condenser alarm delay
cht	Dirty condenser warning
CHT	Dirty condenser alarm

Fig. 9.f

When the temperature $Ac - AE/2$ is exceeded, warning cht is generated to signal that the condenser is possibly obstructed. If the temperature subsequently returns below $Ac - AE$, the warning ceases automatically. If on the other hand the condensing temperature rises above the alarm threshold Ac for a time greater than the value set for parameter ACd , alarm CHT is generated and the compressor is stopped. Alarm CHT is reset manually; this is done by setting parameter rSA.

9.7 Frost protection alarm

If the frost protection temperature probe is fitted, the iJF controller can manage the frost protection alarm.

Par.	Description	Def.	Min	Max	UOM	User	User terminal
/Fq	Assign frost protection probe:	0	7	1	-	S	NO
	0 disabled	4	S4				
	1 S1	5	reserved				
	2 S2	6	S1H				
	3 S3	7	S2H				
AF	Frost protection alarm threshold	-5/-9	-50/-58	250/392	°C/°F	S	NO
AFd	Frost protection alarm delay	1	0	15	min	S	NO

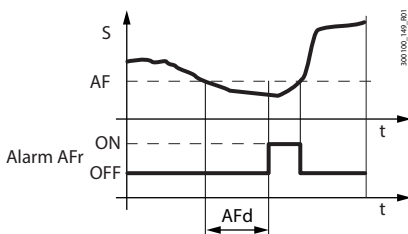

Ref.	Description
t	Time
AF	Frost protection alarm threshold
AFd	Frost protection alarm delay
AFr	Frost protection alarm
S	Frost protection temperature

Fig. 9.g

When the frost protection temperature falls below the alarm threshold AF for a time greater than the value set for parameter AFd , alarm Afr is generated and the compressor is stopped. Alarm Afr is reset automatically when the temperature rises above the threshold AF .

9.8 Refrigerant leak alarm rSF

The iJF controller manages an algorithm that checks if the temperature decreases after the compressor is switched on; if the temperature does not decrease sufficiently, the controller attempts to perform a number of defrosts. If even after defrosting the temperature still does not fall, it is assumed that there has been a refrigerant leak and manual-reset alarm rSF is generated, which stops the unit.

Code	Description	Def.	Min	Max	UOM	User	User terminal
d20	Sampling time for alarm rSF	0	0	240	min	M	NO
d16	Time with no temperature decrease before starting defrost	30	Add	240	min	M	NO
d21	Number of defrosts allowed before signalling alarm rSF	2	1	5	-	M	NO
d22	Temperature difference to verify decrease	0.1/0.2	0.1/0.2	0.5/0.9	Δ °C/°F	M	NO

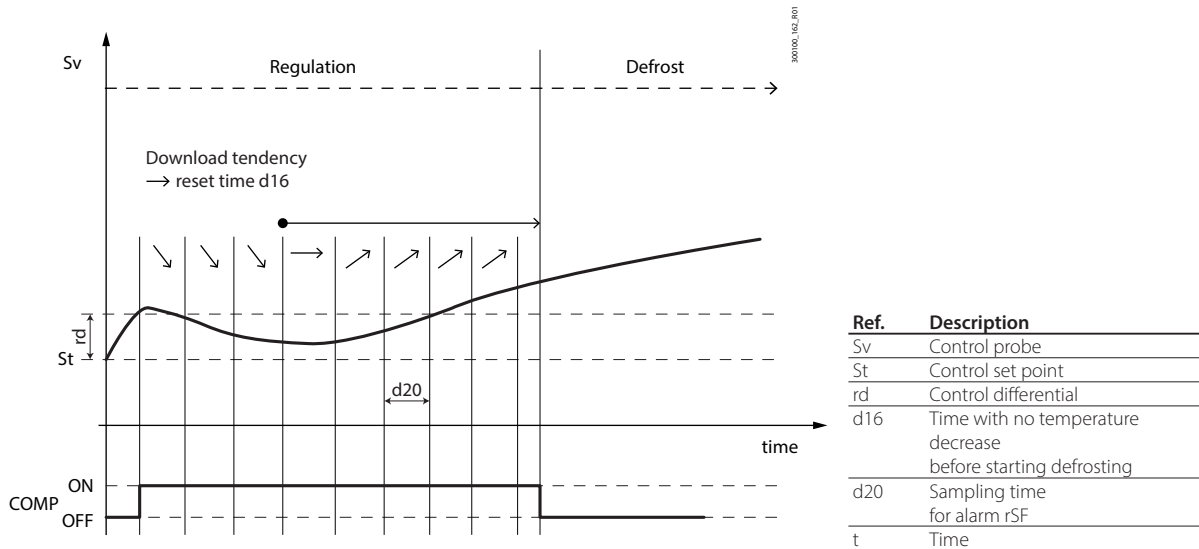

Fig. 9.h

After switching on the compressor, the iJF controller checks at the intervals set for d20 that the control temperature falls by at least by the value set for parameter d22; at the end of each interval, if the temperature decreases, the time with no temperature decrease is reset; on the other hand, if the temperature remains constant or increases, the controller starts counting the time with no temperature decrease, and on reaching the threshold set by parameter d16, a defrost is started. This operating cycle is repeated for a maximum number of defrosts set by parameter d21, after which alarm rSF is activated and the unit is switched off. Alarm rSF is reset manually using parameter rSA.

9.9 Maintenance alarm

The iJF controller can count the time that elapses since maintenance was last carried out, and signal a maintenance request alarm.

Code	Description	Def	Min	Max	UOM	User	User terminal
HMP	Operating hour threshold for maintenance alarm hx1000	0	0	45	h/1000	M	NO
HMr	Reset operating hours	0	0	1	-	S	YES

If the RTC clock is available and working correctly, the iJF controller can count the number of hours that have elapsed since the last time the operating hours were reset. When the threshold set by parameter HMP is exceeded, the maintenance request alarm SrC is signalled. Alarm SrC is reset manually by resetting the operating hours using parameter HMr. Parameter HMr can be used to reset the count of operating hours since maintenance was last carried out even if the alarm has not been activated. If the operating hour threshold HMP=0 (default), the alarm is disabled.

Notice: the maintenance alarm can only be activated on models fitted with RTC and with the clock set correctly.

9.10 VCC compressor alarms with serial control

For VCC compressors with serial control, the iJF controller manages several additional alarms, either detected by the inverter or by the controller itself:

	Description	Message on the display
Detected by the inverter	Failed start-up	UCF
	Overload condition	
	Short circuit	
	Incorrect rotor position	
	Overtemperature	
Detected by the controller	Serial communication errors	COM
	Offline	

Tab. 9.d

Par.	Description	Def	Min	Max	UOM	User	User terminal
CoA	Display alarms detected by the inverter: 0 = display disabled; 1 = display enabled.	1	0	1	-	M	NO
Ctd	Maximum VCC inverter communication failure time before alarm is shown on the display (0 = display disabled)	15	0	60	s	M	NO

To stop these alarms being shown on the display, set the following parameters:

- CoA = display alarms detected by the inverter; when the inverter detects a VCC malfunction, alarm UCF is shown on the display.
- Ctd = maximum time with no communication before the alarm is shown on the display; when the iJF controller detects no communication with the inverter for a time equal to Ctd, alarm COM is shown on the display.

Notice: to disable the alarms relating to VCC compressors on models with the VCC option yet without the inverter connected, set parameters cct and ctd to zero.

10. LOGS

The iJF controller can record both periodic and event logs, which can then be viewed and downloaded using the Applica app and commissioning tools. To view the logs from Applica, select Service Area -> Trend -> (tab) Logs for the periodic logs, or Service Area -> Trend -> (tab) Events for event logs:



Fig. 10.a

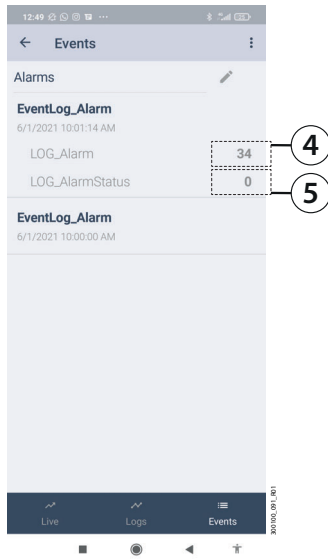

Fig. 10.b

Ref.	Description
1	Preset
2	Periodically logged variables
3	Tools to modify the display
4	Alarm status (0= not active; 1 = active)
5	Alarm code (See the Alarm table)

The log view is pre-set, however it can be changed using the editing tools. In addition, the pre-set views loaded on the device allow the main values to be filtered (temperature, HACCP alarms, blackouts, etc.). To download the logs, use the drop-down menu at the top right.

10.1 Periodic logs

The periodic logs record the main values at regular intervals, as shown in the table.

Logged value	UOM	Period
Control temperature	°C/°F	5 min
Current temperature set point.	°C/°F	1 h
Current humidity	% rh	1 h
Current humidity set point	% rh	1 h
Maximum temperature in the period	°C/°F	1 h
Minimum temperature in the period	°C/°F	1 h
Current evaporation temperature	°C/°F	1 h
Current condensing temperature	°C/°F	1 h
Compressor, minutes ON in the period	min	1 h
Compressor, starts in the period	-	1 h
Evaporator fan, minutes ON in the period	min	1 h
Lights, minutes ON in the period	min	1 h
Defrost, minutes ON in the period	min	1 h
Low temperature alarm relative threshold	Δ °C	1 h
Low temperature alarm relative threshold	Δ °C	1 h

Tab. 10.a

10.2 Event log

Event logs are recorded when specific conditions occur, and can be used to store certain related values, as shown in the table.

Logged value	Event	Other recorded values	Number of samples (*)	Limits
Alarm	Alarm activation	Number of the active alarm with highest priority. Alarm status (active/ceased)	100	max 255 alarm
Blackout	Device ON	Power failure duration in minutes	100	1000 hours
HACCP alarms	HA or HF alarm	Type HA or HF alarm	50	-

Tab. 10.b

(*) The samples are stored in a circular FIFO list (e.g. for the alarms, the 21st alarm overwrites the 1st alarm, and so on). The type of alarm recorded in the log can be identified using the alarm code (see the Alarm table).

⚠ Caution: changing the time set on the iJF controller by more than 140 minutes will clear the stored logs.

11. APPENDIX

11.1 ir33 and IJ parameter compatibility table

The table below shows the parameters from the Carel PJ and IR33 platforms that have changed name or function in the IJ platform. The parameters not listed in this chapter have retained the same name and the same function.

ir33	IJ	Description	Default	Min	Max	UOM
AF	-	Not present	-	-	-	-
AP	-	Not present	-	-	-	-
Apd	-	Not present	-	-	-	-
H6	-	Not present	-	-	-	-
H9	-	Not present	-	-	-	-
/c1, /c2,	/cA	Outlet temperature probe (Sm) calibration	0	-20/ -36	20/ 36	Δ °C/ °F
/c3, /c4, /c5	/cb	Defrost temperature probe (Sd) calibration	0	-20/ -36	20/ 36	Δ °C/ °F
	/cc	Intake temperature probe (Sr) calibration	0	-20/ -36	20/ 36	Δ °C/ °F
	/cF	Auxiliary evaporator defrost temperature probe (Sd2) calibration	0	-20/ -36	20/ 36	Δ °C/ °F
	/cG	Auxiliary temperature probe 1 calibration	0	-20/ -36	20/ 36	Δ °C/ °F
	/cH	Auxiliary temperature probe 2 calibration	0	-20/ -36	20/ 36	Δ °C/ °F
	/cI	Ambient temperature probe calibration	0	-20/ -36	20/ 36	Δ °C/ °F
	/cM	Glass temperature probe calibration	0	-20/ -36	20/ 36	Δ °C/ °F
	/co	Condensing temperature probe calibration	0	-20/ -36	20/ 36	Δ °C/ °F
	/cp	Humidity probe calibration	0	-20/ -36	20/ 36	Δ °C/ °F
	/cq	Frost protection temperature probe calibration	0	-20/ -36	20/ 36	Δ °C/ °F
	/cr	Product temperature probe calibration	0	-20/ -36	20/ 36	Δ °C/ °F
/A2, /A3, /A4, /A5	/FA	Assign outlet temperature probe (Sm) 0 = Function disabled 1 = Probe S1 2 = Probe S2 3 = Probe S3 4 = Probe S4 5 = Reserved 6 = Probe S1H 7 = Probe S2H	1	0	7	-
	/Fb	Assign defrost temperature probe (Sd) - see /FA	0	0	7	-
	/Fc	Assign intake temperature probe (Sr) - see /FA	0	0	7	-
	/FF	Assign auxiliary evaporator defrost temperature probe (Sd2) - see /FA	0	0	7	-
	/FG	Assign auxiliary temperature probe 1 (Saux1) - see /FA	0	0	7	-
	/FH	Assign auxiliary temperature probe 2 (Saux1) - see /FA	0	0	7	-
	/FI	Assign ambient temperature probe (SA) - see /FA	0	0	7	-
	/FM	Assign glass temperature probe (Svt) - see /FA	0	0	7	-
	/Fo	Assign condensing temperature probe - see /FA	0	0	7	-
	/FP	Assign humidity probe (fixed on S5)	5	5	5	-
	/Fq	Assign frost protection temperature probe - see /FA	0	0	7	-
	/FR	Assign product temperature probe - see /FA	0	0	7	-
H2	/nE	Enable user terminal navigation: 0 = enabled; 1 = disabled	0	1	1	-
/P	/P1	Configuration of probes S1, S2, S3, S4, B5 0 = PT1000; 1 = PTC; 2 = NTC; 3 = NTC-LT; 4 = NTC-HT.	2	0	4	-
	/P2	Configuration of multifunction input S3/DI1: 0, 1, 2, 3, 4 = S3; 5 = DI1.	5	0	5	-
/tl	/t1	Display on user terminal: 0 = Not configured 1 = value of S1 2 = value of S2 3 = value of S3 4 = value of S4 5 = value of S1H 6 to 8 = not available 9 = control probe 10 = virtual probe 11 to 14 = not available 15 = actual control set point	9	0	15	-
/tE	/t2	Display on remote display - see /t1	0	0	15	-
A8	A3	Defrost terminated after maximum time signal: 0 = disabled; 1 = enabled	30	1	240	min
d8d	Add	High temp. alarm bypass time for door open	-5.0	-50.0	200.0	°C/°F
ALF	AF	Frost protection alarm threshold	1	0	15	min
AdF	Afd	Frost protection alarm delay time	1	0	15	min
d9	c7	Defrost priority over continuous cycle: 0 = continuous cycle has priority; 1 = defrost has priority	0	0	1	-
cc, cPd	cc	Continuous cycle running time (0 = disabled)	0	0	72	h
c7	cPt	Maximum pump down time (0 = pump down disabled)	0	0	900	s
d3	d15	Start defrost threshold	0	0	240	min
d12	d7	Skip defrost: 0 = disabled; 1 = enabled	0	0	1	-

ir33	iJ	Description	Default	Min	Max	UOM	
A4, A5, A9	DIA	Assign immediate external alarm digital input: 0 = Disabled; 1 = ID1; 2 = ID2; 3 = D1H; 4 = D2H.	0	0	4	-	
	Dib	Assign delayed external alarm digital input - see DIA	0	0	4	-	
	Dic	Assign enable defrost digital input - see DIA	0	0	4	-	
	DId	Assign start defrost digital input - see DIA	0	0	4	-	
	DIE	Assign door switch with compressor OFF digital input - see DIA	0	0	4	-	
	DIF	Assign remote ON/OFF digital input - see DIA	0	0	4	-	
	DIG	Assign curtain switch digital input - see DIA	0	0	4	-	
	DIH	Assign start/stop continuous cycle digital input - see DIA	0	0	4	-	
	DIo	Assign working parameter set changeover digital input - see DIA	0	0	4	-	
	DIP	Assign door switch without compressor OFF digital input - see DIA	0	0	4	-	
	DIS	Assign generic function alarm digital input logic - see DIA	0	0	4	-	
	DIt	Assign low pressure switch digital input - see DIA	0	0	4	-	
	DIU	Assign AUX output activation digital input - see DIA	0	0	4	-	
	H1, H5	DOA	Assign solenoid/compressor digital output 0 = not configured 4 = digital output 4 (NO4) / 5 (large) 1 = digital output 1 (NO1) 5 = digital output 5 (NO5) 2 = digital output 2 (NO2) 6 = digital output 6 (NO6) 3 = digital output 3 (NO3)	1 (small)	0	6	-
DOb		Assign alarm digital output - see DOA	0 (small) / 2 (large)	0	6	-	
DOC		Assign AUX auxiliary digital output - see DOA	0 (small) / 1 (large)	0	6	-	
DOE		Assign light digital output - see DOA	4 (small) / 3 (large)	0	6	-	
DOG		Assign defrost digital output - see DOA	2 (small) / 6 (large)	0	6	-	
DOH		Assign auxiliary evaporator defrost digital output - see DOA	0	0	6	-	
DOI		Assign evaporator fan digital output - see DOA	0	0	6	-	
DOj		Assign dehumidification digital output - see DOA	0	0	6	-	
DOK		Assign auxiliary compressor without rotation digital output - see DOA	0	0	6	-	
DOn		Assign pump down valve digital output - see DOA	0	0	6	-	
DOP		Assign drain heater digital output - see DOA	0	0	6	-	
DOQ		Assign anti-sweat heater digital output - see DOA	0	0	6	-	
DOS		Assign generic On/Off function digital output - see DOA	0	0	6	-	
DOt		Assign condenser fan digital output - see DOA	0	0	6	-	
DOu		Assign humidification digital output - see DOA	0	0	6	-	
DOv		Assign reverse digital output with dead band control - see DOA	0	0	6	-	
DOw		Assign auxiliary parallel compressor digital output - see DOA	0	0	6	-	
DOx		Assign gasket heater digital output - see DOA	0	0	6	-	
DOy		Assign auxiliary compressor with rotation digital output - see DOA	0	0	6	-	
DOz		Assign external dehumidifier digital output - see DOA	0	0	6	-	
F5		F5d	Condenser fan activation differential	5/9	0.1/ 0.2	60/ 108	°C/°F
Ado		H14	Time light stays on after closing the door	0	0	240	min
H4		Hb	Buzzer: 0 = disabled; 1 = enabled	1	0	1	-
HF		HF1	Activation date and time of the first, second and third type HF alarm	-
Hdn	IS	Configuration to be loaded (0 = no configuration selected)	0	0	...	-	
Pw	PDM	Manufacturer password (OEM)	44	0	999	-	
	PDS	Service password	22	0	999	-	
	PDU	User password	0	0	999	-	
r3	r30	Control mode: 0 = direct with defrost; 1 = direct; 2 = reverse	0	0	2	-	
r5	rM	Enable temperature monitoring: 0 = disabled; 1 = enabled	0	0	1	-	
tof_d_	tE1- d, ..., tE8-d	End time band 1 to 8 - day, see (td1...8-d)	0	0	11	-	
tof_h_	tE1-hh, ..., tE8-hh	End time band 1 to 8 - hours	0	0	23	hours	
tof_m_	tE1-mm, ..., tE8-mm	End time band 1 to 8 - minutes	0	0	59	minutes	
toF	tE1- time, ..., tE8- time	End time band 1 to 8 (Applica)	0:00:00	0:00:00	23:59:59	-	
ton_d_	tS1- d, ..., tS8-d	Start time band 1 to 8 - day, see (td1...8-d)	0	0	11	-	
ton_h_	tS1-hh, ..., tS8-hh	Start time band 1 to 8 - hours	0	0	23	hours	
ton_m_	tS1- mm, ..., tS8-mm	Start time band 1 to 8 - minutes	0	0	59	minutes	
ton	tS1- time, ..., tS8- mm	Start time band 1 to 8 (Applica)	0:00:00	0:00:00	23:59:59	-	
-	cuF	Conversion factor from frequency (Hz) to compressor speed (rpm)	30	0	999	rpm *1/ hz	

Tab. 11.a

11.2 Input/output configuration procedure

The inputs and outputs can be configured in the Applica app or configuration tool by setting the corresponding parameters.



Fig. 11.a

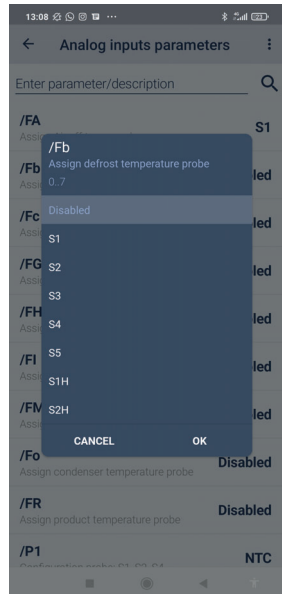

Fig. 11.b

Procedure:

1. open Applica on the smartphone;
2. access the controller via NFC or Bluetooth, entering the profile credentials;
3. move the device closer to the iJF from to modify the input/output configuration on (NFC connection only);
4. access Service Area-> I/O;
5. select the Inputs or Outputs tab;
6. select the modification tool corresponding to the group of inputs/outputs to be modified;
7. select the parameter corresponding to the function to be added or modified (the example in the figure shows the defrost probe assignment) and set the input/output to be associated with the function; press OK to confirm;
9. select "Write" from the drop-down menu at the top right, move the device closer to the iJF and tap "Applica" (NFC connection only).

Analogue inputs

Code	Description	Def	Min	Max	UOM	User	User terminal
/P1	Configuration of probes S1, S2, S3, S4, B5 0 = PT1000; 1 = PTC; 2 = NTC; 3 = NTC-LT; 4 = NTC-HT	2	0	4	-	M	NO
/P2	Configuration of multifunction input S3/ DI1: 0, 1, 2, 3, 4 = S3; 5 = DI1	5	0	5	-	M	NO
/FA	Assign outlet temperature probe (Sm) 0 = Function disabled 1 = Probe S1 2 = Probe S2 3 = Probe S3 4 = Probe S4 5 = Reserved 6 = Probe S1H 7 = Probe S2H	1	0	7	-	M	NO
/Fb	Assign defrost temperature probe (Sd) - see /FA	0	0	7	-	M	NO
/Fc	Assign intake temperature probe (Sf) - see /FA	0	0	7	-	M	NO

To set the type of probe, use parameter /P1.

Digital inputs

Code	Description	Def	Min	Max	UOM	User	User terminal
DIb	Assign delayed external alarm digital input - see DIA	0	0	4	-	M	NO
DIc	Assign enable defrost digital input - see DIA	0	0	4	-	M	NO
DI d	Assign start defrost digital input - see DIA	0	0	4	-	M	NO
DI E	Assign door switch with compressor OFF digital input - see DIA						
DI F	Assign remote ON/OFF digital input - see DIA						
DI G	Assign curtain switch digital input - see DIA	0	0	4	-	M	NO
DI H	Assign start/stop continuous cycle digital input - see DIA	0	0	4	-	M	NO
DI o	Assign working parameter set changeover digital input - see DIA	0	0	4	-	M	NO
DI P	Assign door switch without compressor OFF digital input - see DIA	0	0	4	-	M	NO
DI S	Assign generic function alarm digital input logic - see DIA	0	0	4	-	M	NO
DI t	Assign low pressure switch digital input - see DIA	0	0	4	-	M	NO
DI U	Assign AUX output activation digital input - see DIA	0	0	4	-	M	NO
rS1	Working parameter set associated with open digital input - see DIo	1	0	IS_max	-	M	NO
rS2	Working parameter set associated with closed digital input - see DIo	2	0	IS_max	-	M	NO

11.3 Setting the default parameters/loading the parameter sets

The working set contains the group of parameters used by the iJF controller during normal operation. This set is loaded whenever the iJF controller is started, and the parameters can be modified at any time from the terminal, supervisor, Applica app and configuration software. This set of parameters, customised by the user to control their refrigeration system, can be saved in a configuration using Applica. Subsequently the configuration can be retrieved and loaded onto the controller again using Applica.

iJF also stores a default parameter set in its memory; this set can never be overwritten, being stored in a non-modifiable memory area. The default configuration can be loaded to restore the system to factory conditions.

Various parameter configurations can also be loaded into the device's internal memory, and then selected as the working set as desired. A specific parameter can therefore be set to apply the different configurations directly from the terminal or in Applica. The configurations can be created, modified and applied using specific configuration tools distributed by Carel (Spark and Sparkly) or can be loaded during production phase (see "Preparing and using the configurations" for details).

11.3.1 Procedure for setting the default parameters/loading the parameter sets

Par.	Description	Def.	Min.	Max.	UoM
IS	Working configuration	0	0	IS_Max	-
IS_max	Number of embedded configurations	0	0	999	-
rSC	Restore default values	0	0	1	-

User terminal (see "User interface" for details)

Procedure:

1. unlock the keypad by holding the PROGRAM button for 3 s;
2. access the parameter setting menu by pressing the PROGRAM button;
3. use the UP and DOWN buttons to scroll the submenus until selecting "Ctl";
4. use the UP and DOWN buttons to scroll the parameters until selecting "rSC" to restore the Carel default values, or "IS" to load one of the parameter sets available on the controller;
5. to reset the parameters to the default values, after having selected parameter "rSC", press UP/DOWN to set the value 1 and confirm by pressing PROGRAM;
6. to load one of the parameter sets available on the controller, after selecting parameter "IS", press UP/DOWN to choose the value corresponding to the parameter set to be loaded as the working set, and confirm by pressing PROGRAM.

Applica

Procedure:

1. open Applica on the smartphone;
2. access the controller via NFC or Bluetooth, entering your profile credentials;
3. scroll to parameter "rSC" (if enabled in the access profile) to restore the Carel default values, or "IS" to load one of the parameter sets available on the controller;
4. set parameter "rSC" or "IS" and confirm.



Notice: the visibility of parameters "rSC" and "IS" depends on the access profile used and whether or not there are any preloaded configurations, respectively.

Applying a configuration means copying the set values of the configuration parameters to the working parameters. Any empty parameters (parameters without values set in that configuration) will remain unaffected. The copy procedure is started by changing the value of parameter IS.

Once the configuration has been applied, the value of any of the parameters can be modified without affecting the configuration loaded on the controller, which can thus be recalled at any time, firstly setting the corresponding parameter to 0 and then to the value associated with the desired configuration.



Notice:

- the parameters contained in a configuration cannot be modified in any way.
- Any parameters that are not included in the configuration will remain unchanged, even if the configuration used is changed.
- Recalling the factory parameters resets the settings without however changing the configurations.

11.4 Copy configuration parameters

To simplify operations in the field, Applica includes a “Clone” feature to acquire the configuration from one iJF and replicate it on other controllers.

Procedure:

1. open Applica on the smartphone;
2. access the controller via NFC or Bluetooth, entering the profile credentials;
3. follow the path “Configurations/Clone”;
4. move the smartphone closer to the iJF controller to acquire the configuration from (NFC connection only);
5. following the acknowledgement message, move the smartphone closer to the iJF controller to apply the same configuration to (NFC connection only);
6. wait for the cloning confirmation message to be shown.

Notice: cloning copies all of the parameters, even those not visible to the user based on the access profile. On the other hand, to copy only the parameters that are visible to the user, use the “Create configuration” option, accessible from Service Area -> Setup -> Parameter list.

11.5 Preparing and using the configurations

A configuration is a set of code-value pairs that can contain all, some, or just one parameter.

Example: configuration “1”:

```
rd = 3
St = 2.5
dl = 10
d0 = 1
```

Notice: it is strongly recommended for all configurations to contain the same parameters, to avoid any parameter setting errors that may cause alarms or malfunctions.

The following procedure describes how to create the configurations, load them onto the controller and recall them using the tools described under “Configuration tools”.

11.5.1 Creating configurations

Spark is the tool used to create configurations.

Procedure:

1. open Spark;
2. open the workspace provided by Carel (unique for each software version)
3. select the “Configurations” tab;
4. select “New configuration” and enter the configuration name, which must be a progressive number;
5. in the parameter list, enter the values corresponding to the parameters to be included in the configuration in the “Configuration value” column.

Notice: the configuration name must be a progressive number, with the following format: 1, 2, 3 ... n, other names or non-consecutive values are not allowed.

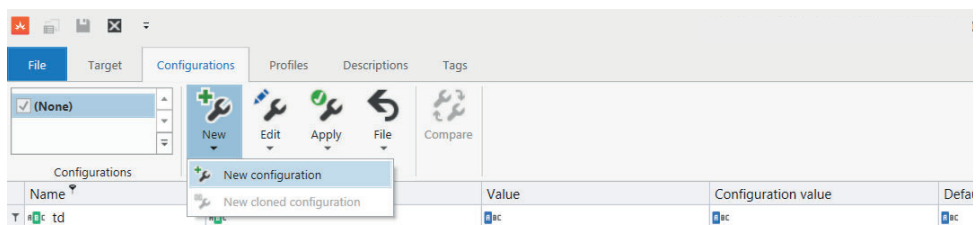

Fig. 11.c

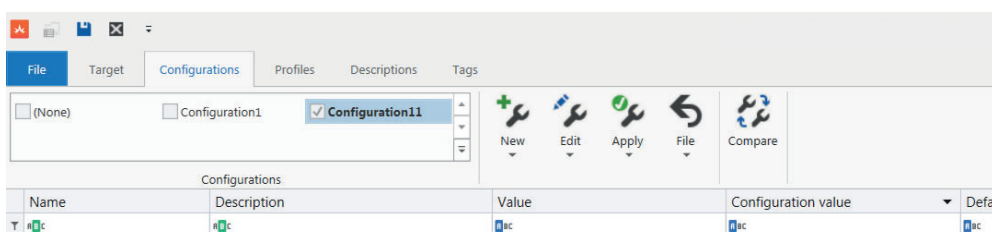



Fig. 11.d

Installing the configurations

Sparkly is the tool used to install configurations on iJF.

Procedure:

1. create a folder on the PC or laptop (C:\Temp);
2. create configurations using Spark and save them in the folder created previously;
3. save the .pack file containing the iJF software version supplied by Carel in the same folder (e.g. HQ000IJF000B0.pack);
4. run Sparkly and write the following command: `pack- file embed -- src "C:\Temp\HQ000IJF000B0.pack" -- configurations "C:\Temp\1.stconfiguration""C:\Temp\2.stconfiguration""C:\Temp\n.stconfiguration"`
5. Press "Enter".

 **Notice:** the configurations must be named with progressive numbers (1.stconfiguration, 2.stconfiguration, etc.). All of the configurations must be entered, no skipped or missing numbers are allowed.

The new .pack file containing the configurations will be generated in the folder and is ready to be installed on the controller.

"Auto-start" configuration

When the .pack file containing the configurations has been created, the configuration that iJF will use at power-on (auto-start) can be selected, rather than using parameter IS (see "Selecting a configuration") by simply adding the configuration name to the end of the string.

Example: the command `pack- file embed -- src "C:\Temp\HQ000IJF000B0_1_3_1.pack" -- configurations "C:\Temp\1.stconfiguration""C:\Temp\2.stconfiguration" -- auto-start "2"` will create a .pack file with the second configuration as auto-start.

Installing configurations via BMS using the CVSTDUMOR0 converter

To install the new .pack file containing the configurations on the iJF controller, run Sparkly and write the following command: `app download - - src "HQ000IJF000B0.pack" - - connection Serial,COM4,1152008N2,1 - - working directory "C:\Temp"`, where COMx is the COM port the converter is connected to, and then press "Enter". Where:

- HQ000IJF000B0: is the name of the .pack file containing the configurations; if modified, it must be replaced by the name of the new .pack file generated using Sparkly;
- COM4: this must be replaced with the COM port used for connection to iJF;
- 115200: the serial communication speed must correspond to the value of parameter H10 on iJF; recommended value at 115200 bps (H10 = 7) for faster loading;
- C:\Temp: is the folder containing the files described above;
- 1: must be replaced with the device's serial address (parameter H0, factory set to 1)

Installing configurations via digital input ID2 using the BXOPZIOWD0000 converter

To install the new .pack file containing the configurations on the iJF controller, run Sparkly and write the following command to enable digital input ID2 as a serial port on iJF: `device enable-serial-on-ID --port COMx --interval 30` and then power on the controller.

From this point on the commands are the same as those used via BMS.

 **Notice:** the serial communication speed for ID2 is fixed at 57600 bps, regardless of the value set for H10.

12. RELEASE NOTES

The software version is shown for a few seconds when the controllers with user interface are switched on (first two digits only), via the BMS variable or Applica app.

The correspondence between the software version and the manual version is shown below.

Software version	Manual version	Description
1.2.2	1.2	First release
1.3.1	20-09-2021	
1.5.0	1.3	Typos corrected
	29-04-2022	

CAREL

CAREL INDUSTRIES - Headquarters

Via dell'Industria, 11 - 35020 Brugine - Padova (Italy)
Tel. (+39) 049.9716611 - Fax (+39) 049.9716600
e-mail: carel@carel.com - www.carel.com

iJF +0300100EN rel. 1.3 - 29.04.2022